



Chipsmall Limited consists of a professional team with an average of over 10 year of expertise in the distribution of electronic components. Based in Hongkong, we have already established firm and mutual-benefit business relationships with customers from,Europe,America and south Asia,supplying obsolete and hard-to-find components to meet their specific needs.

With the principle of “Quality Parts,Customers Priority,Honest Operation,and Considerate Service”,our business mainly focus on the distribution of electronic components. Line cards we deal with include Microchip,ALPS,ROHM,Xilinx,Pulse,ON,Everlight and Freescale. Main products comprise IC,Modules,Potentiometer,IC Socket,Relay,Connector.Our parts cover such applications as commercial,industrial, and automotives areas.

We are looking forward to setting up business relationship with you and hope to provide you with the best service and solution. Let us make a better world for our industry!



Contact us

Tel: +86-755-8981 8866 Fax: +86-755-8427 6832

Email & Skype: info@chipsmall.com Web: www.chipsmall.com

Address: A1208, Overseas Decoration Building, #122 Zhenhua RD., Futian, Shenzhen, China



Features

- Epitaxial Planar Die Construction
- Complementary PNP Types Available (DDTA)
- Built-In Biasing Resistor, R1 only
- **Totally Lead-Free & Fully RoHS Compliant (Notes 1 & 2)**
- **Halogen and Antimony Free "Green" Device (Note 3)**
- **Qualified to AEC-Q101 Standards for High Reliability**
- **PPAP Capable (Note 4)**

Part Number	R1 (NOM)	Marking
DDTC113TE	1kΩ	N01
DDTC123TE	2.2kΩ	N03
DDTC143TE	4.7kΩ	N07
DDTC114TE	10kΩ	N12
DDTC124TE	22kΩ	N16
DDTC144TE	47kΩ	N19
DDTC115TE	100kΩ	N23
DDTC125TE	200kΩ	N25

SOT523



Top View

Mechanical Data

- Case: SOT523
- Case Material: Molded Plastic, "Green" Molding Compound. UL Flammability Classification Rating 94V-0
- Moisture Sensitivity: Level 1 per J-STD-020
- Terminals: Matte Tin Finish. Solderable per MIL-STD-202, Method 208 @3
- Weight: 0.002 grams (Approximate)

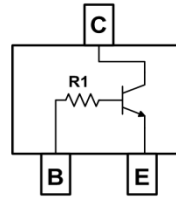

Device Schematic – Top View

Ordering Information (Notes 4 & 5)

Part Number	Compliance	Reel size (inches)	Tape width (mm)	Quantity per reel
DDTC113TE-7-F	AEC-Q101	7	8	3,000
DDTC123TE-7-F	AEC-Q101	7	8	3,000
DDTC143TE-7-F	AEC-Q101	7	8	3,000
DDTC114TE-7-F	AEC-Q101	7	8	3,000
DDTC124TE-7-F	AEC-Q101	7	8	3,000
DDTC124TEQ-7-F	Automotive	7	8	3,000
DDTC144TE-7-F	AEC-Q101	7	8	3,000
DDTC115TE-7-F	AEC-Q101	7	8	3,000
DDTC125TE-7-F	AEC-Q101	7	8	3,000

- Notes:
1. No purposely added lead. Fully EU Directive 2002/95/EC (RoHS) & 2011/65/EU (RoHS 2) compliant.
 2. See http://www.diodes.com/quality/lead_free.html for more information about Diodes Incorporated's definitions of Halogen- and Antimony-free, "Green" and Lead-free.
 3. Halogen- and Antimony-free "Green" products are defined as those which contain <900ppm bromine, <900ppm chlorine (<1500ppm total Br + Cl) and <1000ppm antimony compounds.
 4. Automotive products are AEC-Q101 qualified and are PPAP capable. Automotive, AEC-Q101 and standard products are electrically and thermally the same, except where specified. For more information, please refer to http://www.diodes.com/quality/product_compliance_definitions/.
 5. For packaging details, go to our website at <http://www.diodes.com/products/packages.html>.

Marking Information

SOT523

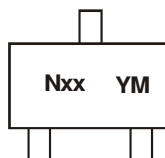

Nxx = Product Type Marking Code
(See Table in Features)
YM = Date Code Marking
Y = Year (ex: C = 2015)
M = Month (ex: 9 = September)

Date Code Key

Year	2015	2016	2017	2018	2019	2020	2021	2022	2023	2024
Code	C	D	E	F	G	H	I	J	K	L

Month	Jan	Feb	Mar	Apr	May	Jun	Jul	Aug	Sep	Oct	Nov	Dec
Code	1	2	3	4	5	6	7	8	9	O	N	D

Absolute Maximum Ratings (@T_A = +25°C, unless otherwise specified.)

Characteristic	Symbol	Value	Unit
Collector Base Voltage	V _{CBO}	50	V
Collector-Emitter Voltage	V _{CEO}	50	V
Emitter-Base Voltage	V _{EBO}	5	V
Collector Current	I _{C(MAX)}	100	mA

Thermal Characteristics (@T_A = +25°C, unless otherwise specified.)

Characteristic	Symbol	Value	Unit
Power Dissipation	P _D	150	mW
Thermal Resistance, Junction to Ambient Air (Note 6)	R _{θJA}	833	°C/W
Operating and Storage Temperature Range	T _J , T _{STG}	-55 to +150	°C

Electrical Characteristics (@T_A = +25°C, unless otherwise specified.)

Characteristic	Symbol	Min	Typ	Max	Unit	Test Condition
Collector-Base Breakdown Voltage	BV _{CBO}	50	—	—	V	I _C = 50μA
Collector-Emitter Breakdown Voltage	BV _{CEO}	50	—	—	V	I _C = 1mA
Emitter-Base Breakdown Voltage	BV _{EBO}	5	—	—	V	I _E = 50μA
Collector Cutoff Current	I _{CBO}	—	—	0.5	μA	V _{CB} = 50V
Emitter Cutoff Current	I _{EBO}	—	—	0.5	μA	V _{EB} = 4V
Collector-Emitter Saturation Voltage	V _{CE(sat)}	—	—	0.3	V	I _C /I _B = 10mA/1mA DDTC113TE I _C /I _B = 5mA/0.5mA DDTC123TE I _C /I _B = 2.5mA/.25mA DDTC143TE I _C /I _B = 1mA/.1mA DDTC114TE I _C /I _B = 5mA/0.5mA DDTC124TE I _C /I _B = 2.5mA/.25mA DDTC144TE I _C /I _B = 1mA/0.1mA DDTC115TE I _C /I _B = .5mA/.05mA DDTC125TE
DC Current Transfer Ratio	h _{FE}	100	250	600	—	I _C = 1mA, V _{CE} = 5V
Input Resistor (R ₁) Tolerance	ΔR ₁	-30	—	+30	%	—
Gain-Bandwidth Product (Note 7)	f _T	—	250	—	MHz	V _{CE} = 10V, I _E = -5mA, f = 100MHz

Notes: 6. Mounted on FR4 PC Board with minimum recommended pad layout.
7. Transistor only.

Typical Curves – DDTC114TE

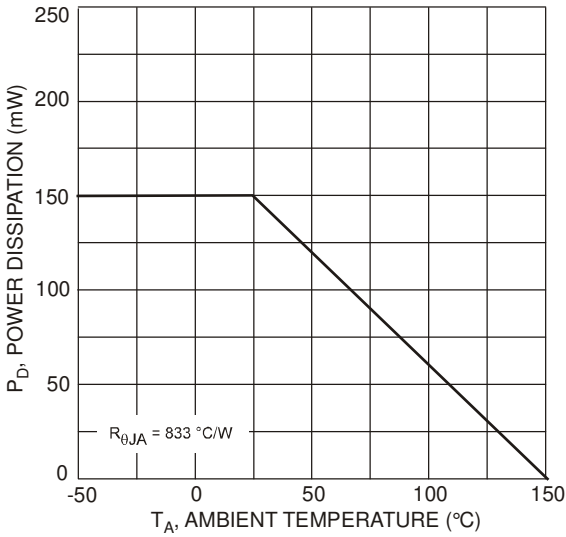

Fig. 1 Power Dissipation vs. Ambient Temperature

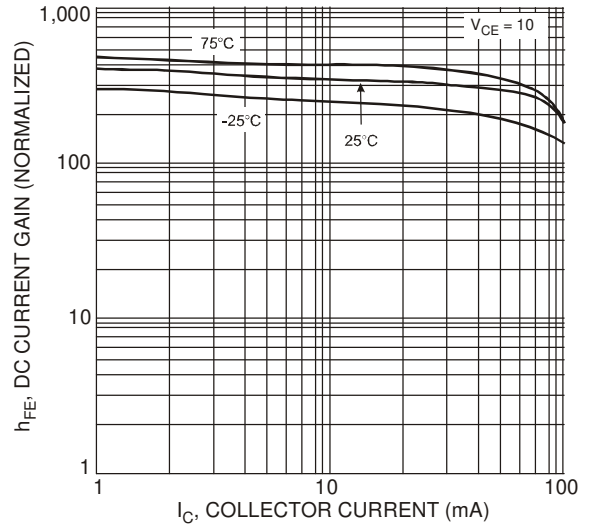

Fig. 2 Typical DC Current Gain vs. Collector Current

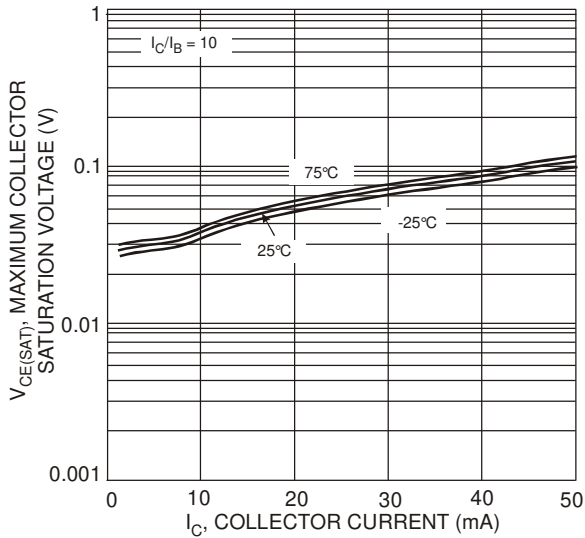

Fig. 3 Typical Collector Emitter Saturation Voltage vs. Collector Current

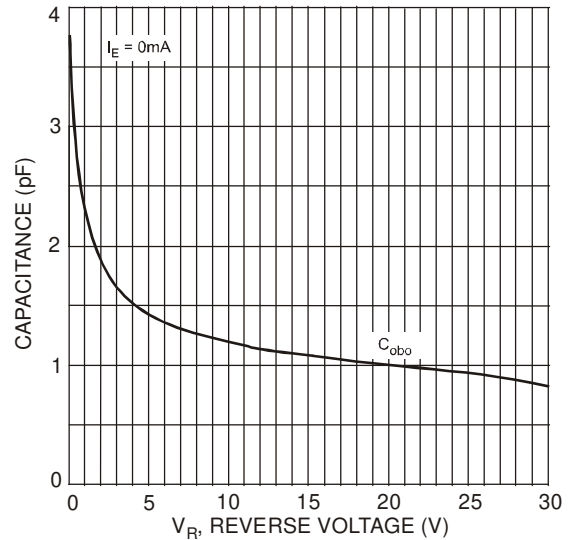

Fig. 4 Typical Capacitance Characteristics

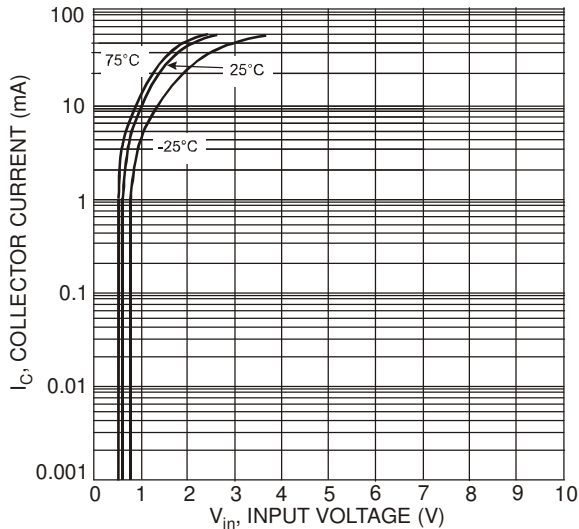

Fig. 5 Collector Current vs. Input Voltage

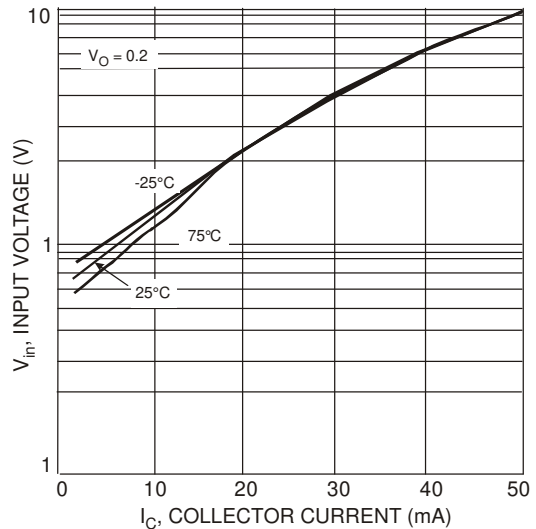
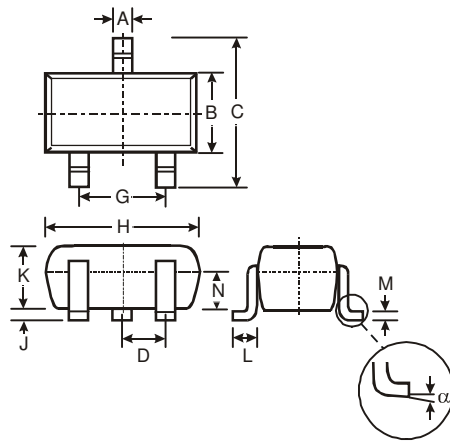

Fig. 6 Input Voltage vs. Collector Current

Package Outline Dimensions

Please see AP02002 at <http://www.diodes.com/datasheets/ap02002.pdf> for the latest version.



SOT523			
Dim	Min	Max	Typ
A	0.15	0.30	0.22
B	0.75	0.85	0.80
C	1.45	1.75	1.60
D	—	—	0.50
G	0.90	1.10	1.00
H	1.50	1.70	1.60
J	0.00	0.10	0.05
K	0.60	0.80	0.75
L	0.10	0.30	0.22
M	0.10	0.20	0.12
N	0.45	0.65	0.50
α	0°	8°	—
All Dimensions in mm			

Suggested Pad Layout

Please see AP02001 at <http://www.diodes.com/datasheets/ap02001.pdf> for the latest version.

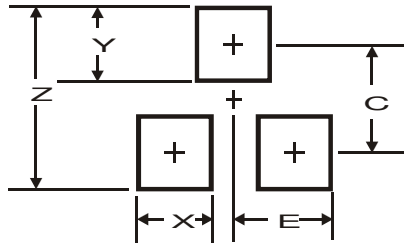

Dimensions	Value (in mm)
Z	1.8
X	0.4
Y	0.51
C	1.3
E	0.7

IMPORTANT NOTICE

DIODES INCORPORATED MAKES NO WARRANTY OF ANY KIND, EXPRESS OR IMPLIED, WITH REGARDS TO THIS DOCUMENT, INCLUDING, BUT NOT LIMITED TO, THE IMPLIED WARRANTIES OF MERCHANTABILITY AND FITNESS FOR A PARTICULAR PURPOSE (AND THEIR EQUIVALENTS UNDER THE LAWS OF ANY JURISDICTION).

Diodes Incorporated and its subsidiaries reserve the right to make modifications, enhancements, improvements, corrections or other changes without further notice to this document and any product described herein. Diodes Incorporated does not assume any liability arising out of the application or use of this document or any product described herein; neither does Diodes Incorporated convey any license under its patent or trademark rights, nor the rights of others. Any Customer or user of this document or products described herein in such applications shall assume all risks of such use and will agree to hold Diodes Incorporated and all the companies whose products are represented on Diodes Incorporated website, harmless against all damages.

Diodes Incorporated does not warrant or accept any liability whatsoever in respect of any products purchased through unauthorized sales channel. Should Customers purchase or use Diodes Incorporated products for any unintended or unauthorized application, Customers shall indemnify and hold Diodes Incorporated and its representatives harmless against all claims, damages, expenses, and attorney fees arising out of, directly or indirectly, any claim of personal injury or death associated with such unintended or unauthorized application.

Products described herein may be covered by one or more United States, international or foreign patents pending. Product names and markings noted herein may also be covered by one or more United States, international or foreign trademarks.

This document is written in English but may be translated into multiple languages for reference. Only the English version of this document is the final and determinative format released by Diodes Incorporated.

LIFE SUPPORT

Diodes Incorporated products are specifically not authorized for use as critical components in life support devices or systems without the express written approval of the Chief Executive Officer of Diodes Incorporated. As used herein:

A. Life support devices or systems are devices or systems which:

1. are intended to implant into the body, or
2. support or sustain life and whose failure to perform when properly used in accordance with instructions for use provided in the labeling can be reasonably expected to result in significant injury to the user.

B. A critical component is any component in a life support device or system whose failure to perform can be reasonably expected to cause the failure of the life support device or to affect its safety or effectiveness.

Customers represent that they have all necessary expertise in the safety and regulatory ramifications of their life support devices or systems, and acknowledge and agree that they are solely responsible for all legal, regulatory and safety-related requirements concerning their products and any use of Diodes Incorporated products in such safety-critical, life support devices or systems, notwithstanding any devices- or systems-related information or support that may be provided by Diodes Incorporated. Further, Customers must fully indemnify Diodes Incorporated and its representatives against any damages arising out of the use of Diodes Incorporated products in such safety-critical, life support devices or systems.

Copyright © 2015, Diodes Incorporated

www.diodes.com