



Chipsmall Limited consists of a professional team with an average of over 10 year of expertise in the distribution of electronic components. Based in Hongkong, we have already established firm and mutual-benefit business relationships with customers from,Europe,America and south Asia,supplying obsolete and hard-to-find components to meet their specific needs.

With the principle of "Quality Parts,Customers Priority,Honest Operation,and Considerate Service",our business mainly focus on the distribution of electronic components. Line cards we deal with include Microchip,ALPS,ROHM,Xilinx,Pulse,ON,Everlight and Freescale. Main products comprise IC,Modules,Potentiometer,IC Socket,Relay,Connector.Our parts cover such applications as commercial,industrial, and automotives areas.

We are looking forward to setting up business relationship with you and hope to provide you with the best service and solution. Let us make a better world for our industry!



Contact us

Tel: +86-755-8981 8866 Fax: +86-755-8427 6832

Email & Skype: info@chipsmall.com Web: www.chipsmall.com

Address: A1208, Overseas Decoration Building, #122 Zhenhua RD., Futian, Shenzhen, China



Part Number: DE4GD

Green

Features

- Uniform light emitting area.
- Easily mounted on P.C. boards or industry standard sockets.
- Flush mountable.
- Excellent on/off contrast.
- Can be used with panels and legend mounts.
- Mechanically rugged.
- RoHS compliant.

Description

The Green source color devices are made with Gallium Phosphide Green Light Emitting Diode.

Package Dimensions & Internal Circuit Diagram

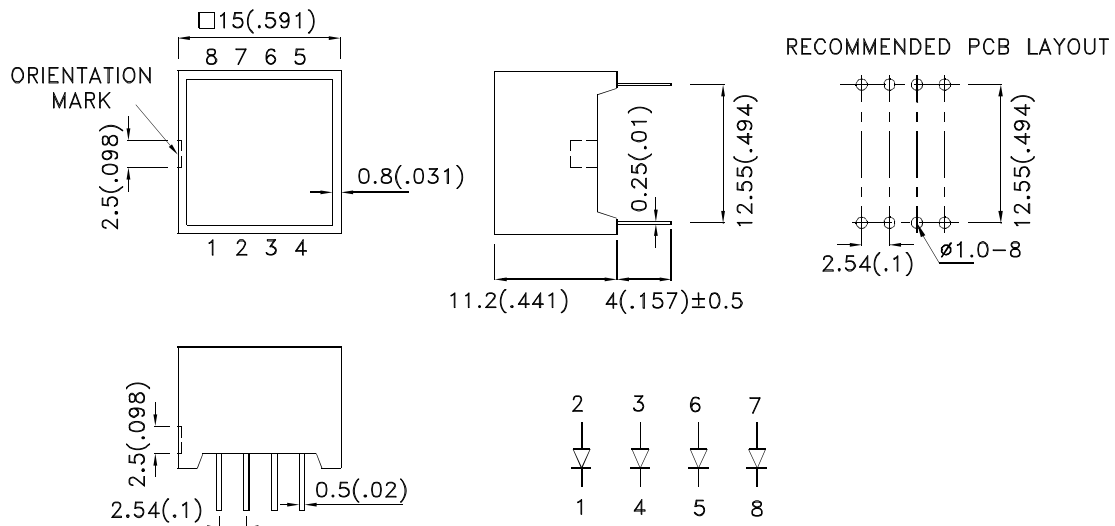

Notes:

1. All dimensions are in millimeters (inches), Tolerance is $\pm 0.25(0.01)$ unless otherwise noted.
2. The specifications, characteristics and technical data described in the datasheet are subject to change without prior notice.



Selection Guide

| Part No. | Dice | Lens Type | Iv (mcd) [1] @ 10mA | |
|----------|-------------|----------------|------------------------|------|
| | | | Min. | Typ. |
| DE4GD | Green (GaP) | Green Diffused | 14 | 36 |

Note:

1. Luminous intensity/ luminous Flux: +/-15%.

Electrical / Optical Characteristics at TA=25°C

| Symbol | Parameter | Device | Typ. | Max. | Units | Test Conditions |
|-----------------------|--------------------------|--------|------|------|-------|---------------------------|
| λ_{peak} | Peak Wavelength | Green | 565 | | nm | I _F =20mA |
| λ_D [1] | Dominant Wavelength | Green | 568 | | nm | I _F =20mA |
| $\Delta\lambda_{1/2}$ | Spectral Line Half-width | Green | 30 | | nm | I _F =20mA |
| C | Capacitance | Green | 15 | | pF | V _F =0V;f=1MHz |
| V _F [2] | Forward Voltage | Green | 2.2 | 2.5 | V | I _F =20mA |
| I _R | Reverse Current | Green | | 10 | uA | V _R =5V |

Notes:

1. Wavelength: +/-1nm.
2. Forward Voltage: +/-0.1V.

Absolute Maximum Ratings at TA=25°C

| Parameter | Green | Units |
|---------------------------------|-----------------------|-------|
| Power dissipation | 62.5 | mW |
| DC Forward Current | 25 | mA |
| Peak Forward Current [1] | 140 | mA |
| Reverse Voltage | 5 | V |
| Operating / Storage Temperature | -40°C To +85°C | |
| Lead Solder Temperature[2] | 260°C For 3-5 Seconds | |

Notes:

1. 1/10 Duty Cycle, 0.1ms Pulse Width.
2. 2mm below package base.

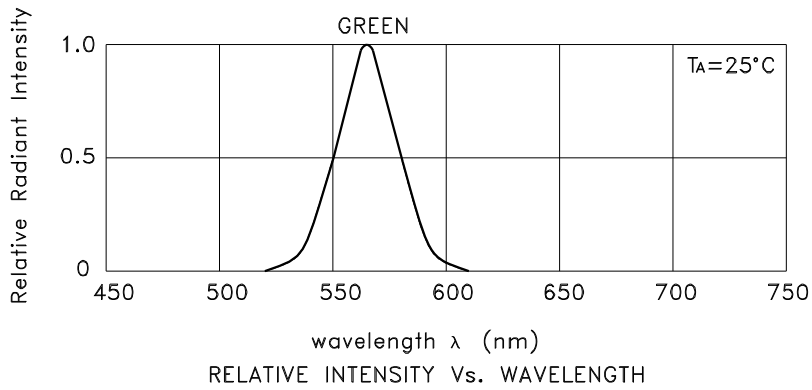

Green

DE4GD

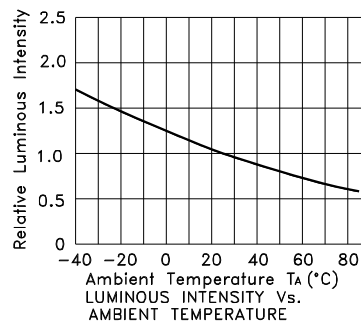
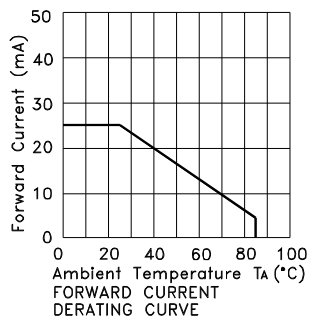
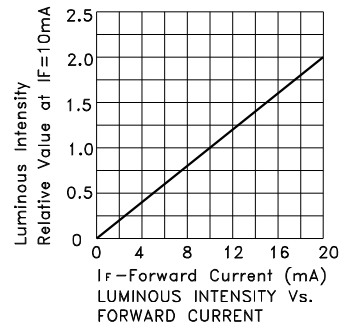
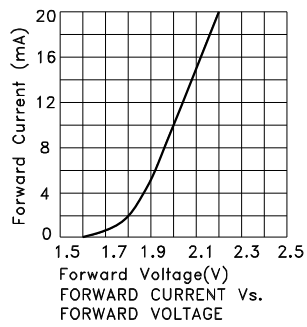

PACKING & LABEL SPECIFICATIONS

DE4GD

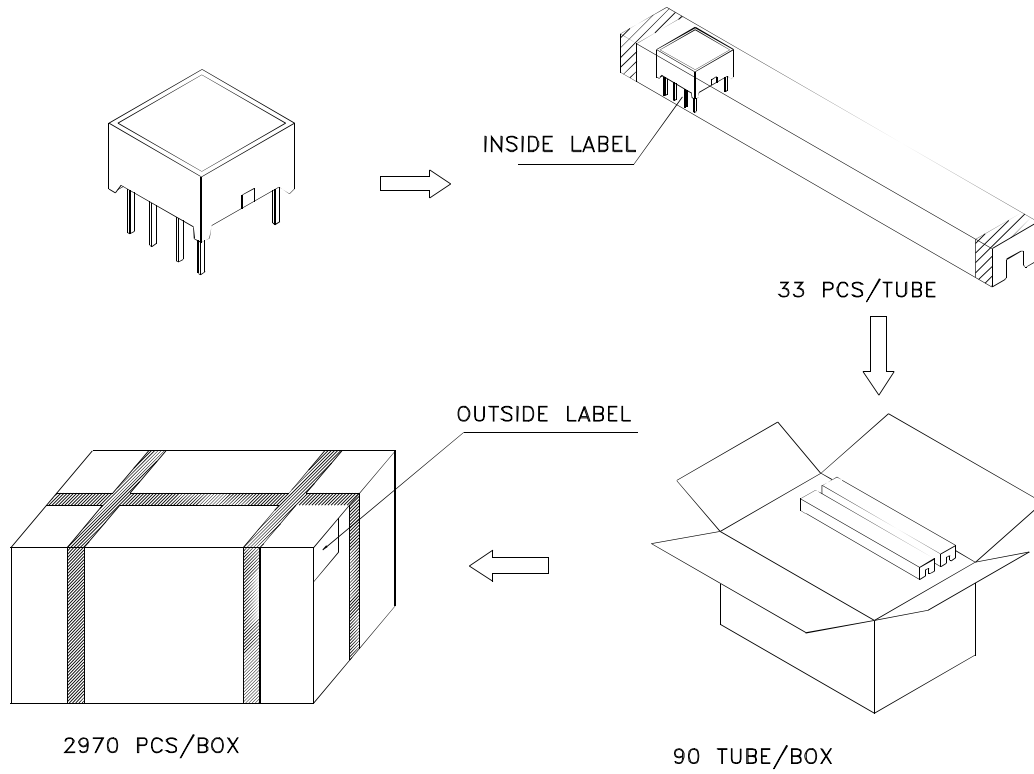

Inside Label On IC-tube

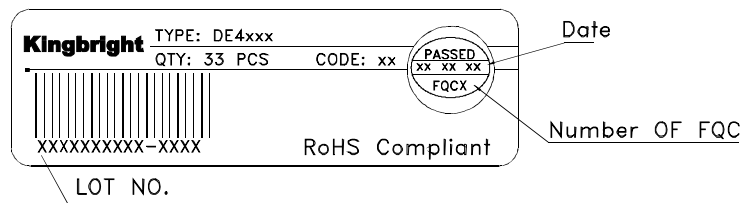

Outside Label On Box

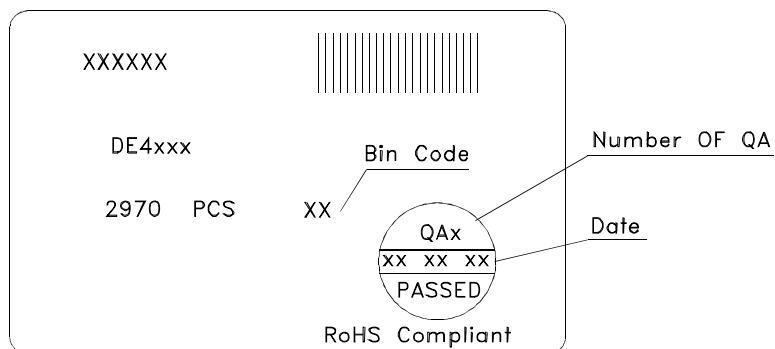

THROUGH HOLE DISPLAY MOUNTING METHOD

Lead Forming

Do not bend the component leads by hand without proper tools.
The leads should be bent by clinching the upper part of the lead firmly such that the bending force is not exerted on the plastic body.

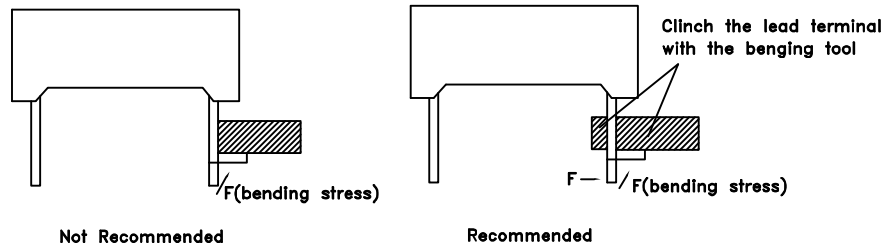

Installation

- 1.The installation process should not apply stress to the lead terminals.
- 2.When inserting for assembly, ensure the terminal pitch matches the substrate board's hole pitch to prevent spreading or pinching the lead terminals.

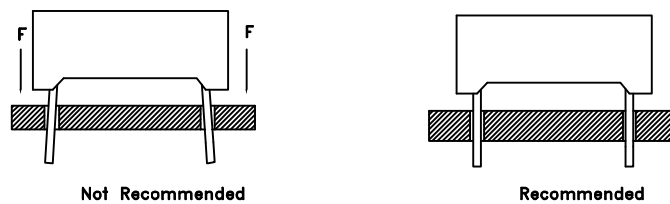

DISPLAY SOLDERING CONDITIONS

Wave Soldering Profile For Lead-free Through-hole LED.

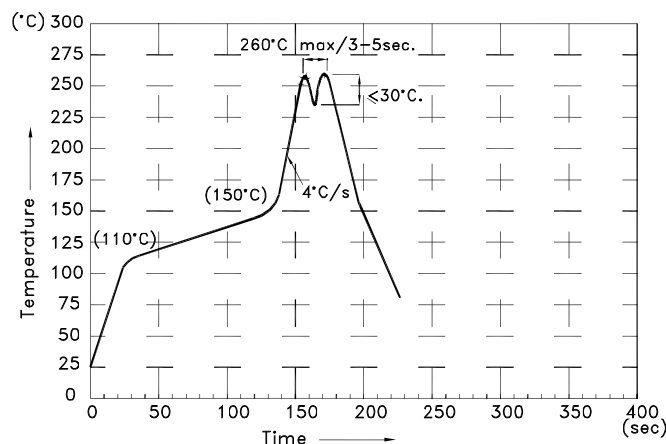

NOTES:

- 1.Recommend the wave temperature 245°C~260°C.The maximum soldering temperature should be less than 260°C.
- 2.Do not apply stress on epoxy resins when temperature is over 85°C.
- 3.The soldering profile apply to the lead free soldering (Sn/Cu/Ag alloy).
- 4.During wave soldering , the PCB top-surface temperature should be kept below 105°C
- 5.No more than once.

Soldering General Notes:

- a. Through-hole displays are incompatible with reflow soldering.
- b. If components will undergo multiple soldering processes, or other processes where the components may be subjected to intense heat, please check with Kingbright for compatibility.

CLEANING

1. Mild "no-clean" fluxes are recommended for use in soldering.
2. If cleaning is required, Kingbright recommends to wash components with water only. Do not use harsh organic solvents for cleaning, because they may damage the plastic parts. And the devices should not be washed for more than one minute.

CIRCUIT DESIGN NOTES

1. Protective current-limiting resistors may be necessary to operate the Displays.
2. LEDs mounted in parallel should each be placed in series with its own current-limiting resistor.

