



Chipsmall Limited consists of a professional team with an average of over 10 year of expertise in the distribution of electronic components. Based in Hongkong, we have already established firm and mutual-benefit business relationships with customers from,Europe,America and south Asia,supplying obsolete and hard-to-find components to meet their specific needs.

With the principle of “Quality Parts,Customers Priority,Honest Operation,and Considerate Service”,our business mainly focus on the distribution of electronic components. Line cards we deal with include Microchip,ALPS,ROHM,Xilinx,Pulse,ON,Everlight and Freescale. Main products comprise IC,Modules,Potentiometer,IC Socket,Relay,Connector.Our parts cover such applications as commercial,industrial, and automotives areas.

We are looking forward to setting up business relationship with you and hope to provide you with the best service and solution. Let us make a better world for our industry!



Contact us

Tel: +86-755-8981 8866 Fax: +86-755-8427 6832

Email & Skype: info@chipsmall.com Web: www.chipsmall.com

Address: A1208, Overseas Decoration Building, #122 Zhenhua RD., Futian, Shenzhen, China





Multilayer Band Pass Filter

For 2412-2484MHz

DEA202450BT-1294C1-H

2.0x1.25mm [EIA 0805]*

* Dimensions Code JIS[EIA]

Multilayer Band Pass Filter

Conformity to RoHS Directive

For 2412-2484MHz

DEA202450BT-1294C1-H

SHAPES AND DIMENSIONS

[Top view]

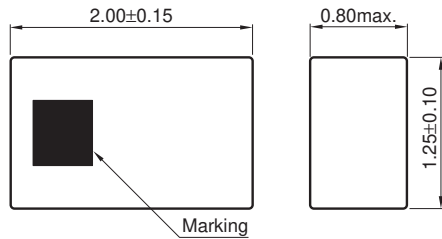

[Bottom view]

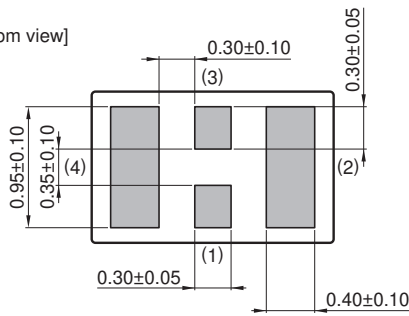

Terminal functions

1	In
2	GND
3	Out
4	GND

Dimensions in mm

RECOMMENDED LAND PATTERN

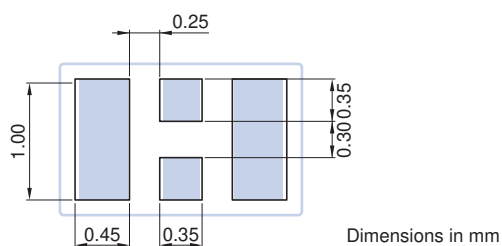

Dimensions in mm

EVALUATION BOARD

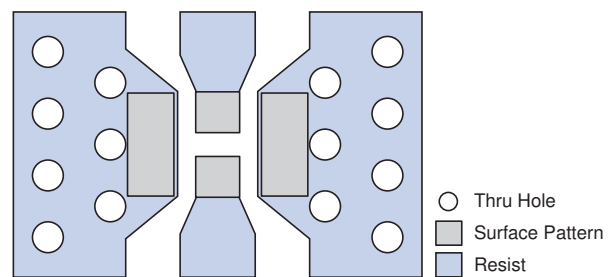

○ Thru Hole
 ■ Surface Pattern
 ■ Resist

Material & Layer	Thickness
Top resist	—
Copper surface pattern	0.035mm
FR4	0.10mm
Inner GND	0.018mm
FR4	0.30mm
Copper bottom GND	0.035mm

Line width should be designed to match 50Ω characteristic impedance, depending on PCB material and thickness.

○ RoHS Directive Compliant Product: See the following for more details. <https://product.tdk.com/info/en/environment/rohs/index.html>

- All specifications are subject to change without notice.
- Before using these products, be sure to request the delivery specifications.

DEA202450BT-1294C1-H

ELECTRICAL CHARACTERISTICS

Item	Frequency Range (MHz)	Min.	Typ.	Max.
Insertion Loss (dB)	2412 to 2484	—	1.02	1.35
Return Loss (dB)	2412 to 2484	10	22	—
	804 to 828	30	42	—
Attenuation (dB)	1608 to 1656	20	23	—
	3216 to 3312	30	49	—
	4020 to 4140	40	52	—
	4824 to 4968	20	30	—
	5628 to 5796	20	27	—
	6432 to 6624	20	42	—
	7200 to 7500	35	44	—
Characteristic Impedance (Ω)	7500 to 10000	20	30	—
				50 (Nominal)

· Ta: +25±5°C

TEMPERATURE RANGE

Operating temperature (°C)	Storage temperature (°C)
-40 to +85	-40 to +85

- All specifications are subject to change without notice.
- Before using these products, be sure to request the delivery specifications.

DEA202450BT-1294C1-H

FREQUENCY CHARACTERISTICS

INSERTION LOSS

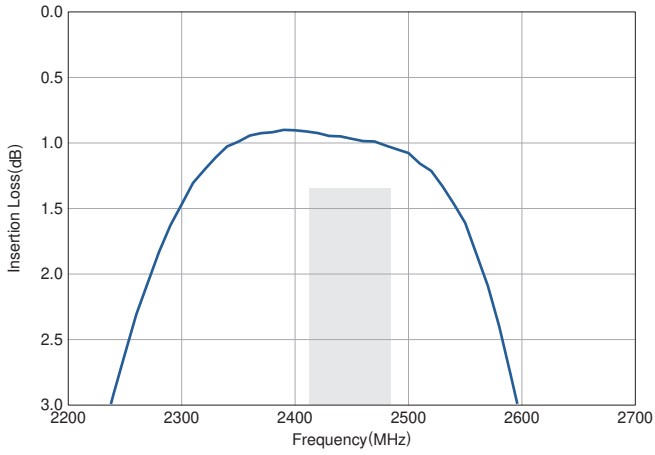

ATTENUATION

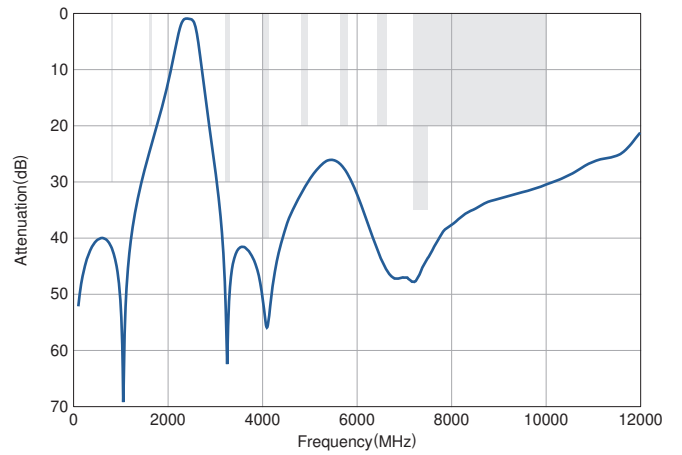

RETURN LOSS

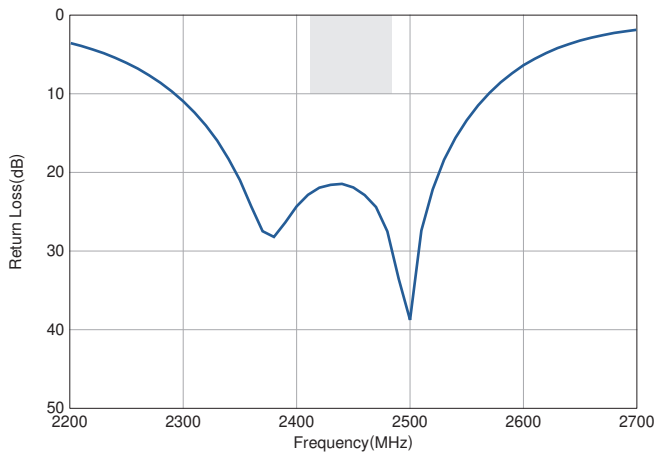

- All specifications are subject to change without notice.
- Before using these products, be sure to request the delivery specifications.

DEA202450BT-1294C1-H

PACKAGING STYLE

REEL DIMENSIONS

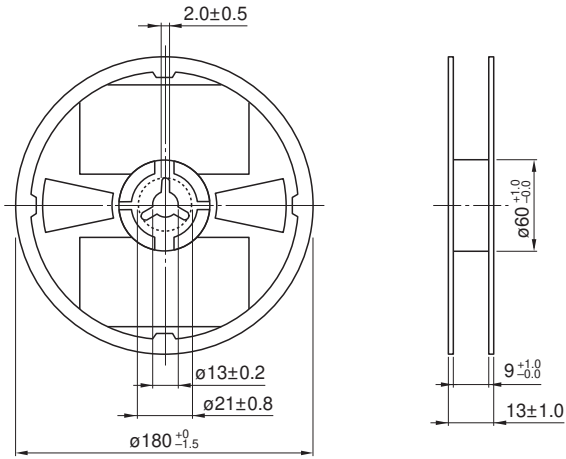

Dimensions in mm

TAPE DIMENSIONS

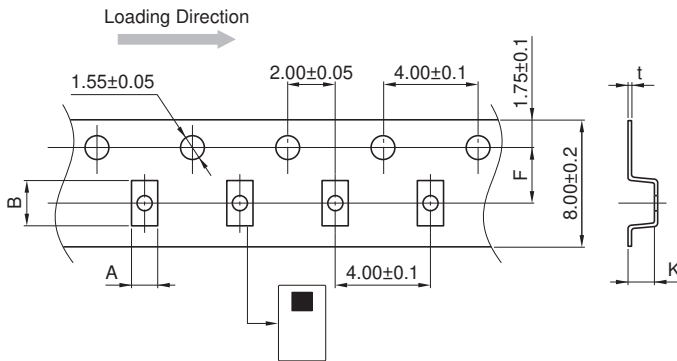

A	B	F	t	K
1.45±0.1	2.25±0.1	3.50±0.05	0.25±0.05	1.00±0.05

PACKAGE QUANTITY

Standard package quantity (pieces/reel)
2000

- All specifications are subject to change without notice.
- Before using these products, be sure to request the delivery specifications.

DEA202450BT-1294C1-H

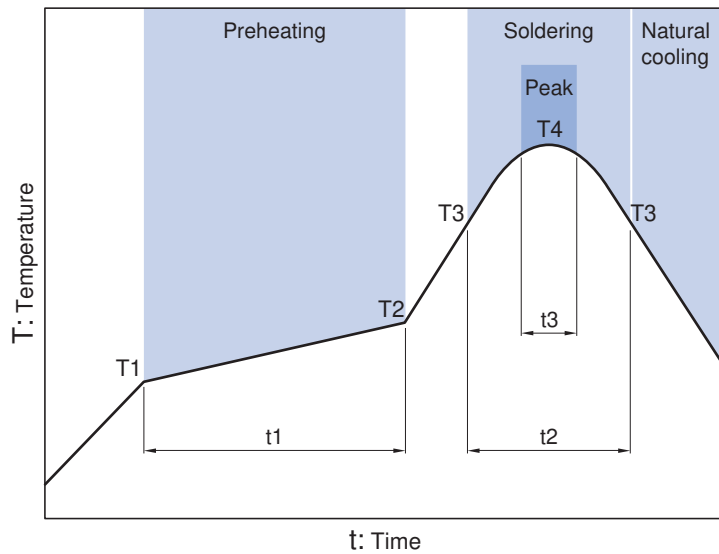
RECOMMENDED REFLOW PROFILE

Soaking			Working		Soldering Peak		
Temp.	T2	Time	Temp.	Time	Temp.	Time	Temp.
T1	T2	t1	T3	t2	T4	t3	T5
150°C	180°C	60 to 120s	230°C	more than 30s	247 to 253°C	within 10s	260°C max.

- All specifications are subject to change without notice.
- Before using these products, be sure to request the delivery specifications.

REMINDERS FOR USING THESE PRODUCTS

Before using these products, be sure to request the delivery specifications.

SAFETY REMINDERS

Please pay sufficient attention to the warnings for safe designing when using these products.

REMINDERS

The products listed on this catalog are intended for use in general electronic equipment (AV equipment, telecommunications equipment, home appliances, amusement equipment, computer equipment, personal equipment, office equipment, measurement equipment, industrial robots) under a normal operation and use condition.

The products are not designed or warranted to meet the requirements of the applications listed below, whose performance and/or quality require a more stringent level of safety or reliability, or whose failure, malfunction or trouble could cause serious damage to society, person or property.

Please understand that we are not responsible for any damage or liability caused by use of the products in any of the applications below or for any other use exceeding the range or conditions set forth in this catalog.

- | | |
|---|--|
| (1) Aerospace/Aviation equipment | (8) Public information-processing equipment |
| (2) Transportation equipment (cars, electric trains, ships, etc.) | (9) Military equipment |
| (3) Medical equipment | (10) Electric heating apparatus, burning equipment |
| (4) Power-generation control equipment | (11) Disaster prevention/crime prevention equipment |
| (5) Atomic energy-related equipment | (12) Safety equipment |
| (6) Seabed equipment | (13) Other applications that are not considered general-purpose applications |
| (7) Transportation control equipment | |

When using this product in general-purpose applications, you are kindly requested to take into consideration securing protection circuit/equipment or providing backup circuits, etc., to ensure higher safety.