



Chipsmall Limited consists of a professional team with an average of over 10 year of expertise in the distribution of electronic components. Based in Hongkong, we have already established firm and mutual-benefit business relationships with customers from,Europe,America and south Asia,supplying obsolete and hard-to-find components to meet their specific needs.

With the principle of “Quality Parts,Customers Priority,Honest Operation,and Considerate Service”,our business mainly focus on the distribution of electronic components. Line cards we deal with include Microchip,ALPS,ROHM,Xilinx,Pulse,ON,Everlight and Freescale. Main products comprise IC,Modules,Potentiometer,IC Socket,Relay,Connector.Our parts cover such applications as commercial,industrial, and automotives areas.

We are looking forward to setting up business relationship with you and hope to provide you with the best service and solution. Let us make a better world for our industry!



Contact us

Tel: +86-755-8981 8866 Fax: +86-755-8427 6832

Email & Skype: info@chipsmall.com Web: www.chipsmall.com

Address: A1208, Overseas Decoration Building, #122 Zhenhua RD., Futian, Shenzhen, China



RF Components for Wireless Applications



TDK RF Components & Services :

- Band Pass Filters
- Diplexers
- Low Pass Filters
- Couplers
- High Frequency Inductors
- Circulators/ Isolators
- Baluns
- Antennas
- High Pass Filters
- Test Services
- Test Equipment
- Anechoic Chambers

Table of Contents

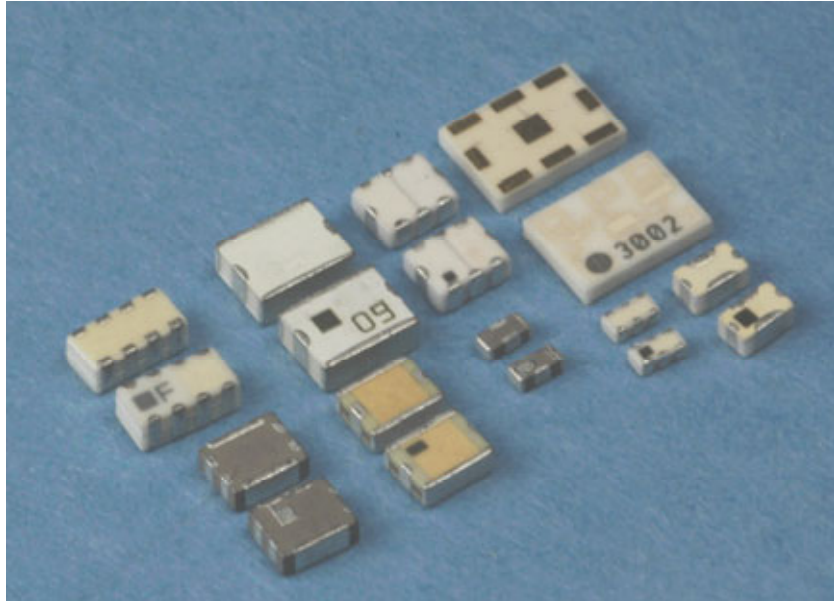

TDK offers a series of RF components for many wireless applications.

From filters and antennas to test services and anechoic chambers solutions, TDK has a solution for you.

● WLAN SOLUTIONS	PAGE	04
● BLUETOOTH SOLUTIONS	PAGE	08
● WiMAX Solutions	Page	10
● UWB SOLUTIONS	PAGE	13

TDK WLAN components provide leading edge miniaturization technology while providing exceptional electrical characteristics. TDK RF Components are recommended by leading WLAN chipset manufacturers.

The following pages list our standard BPF's, LPF's, HPF's, diplexers and baluns for 2.4GHz & 5GHz WLAN.

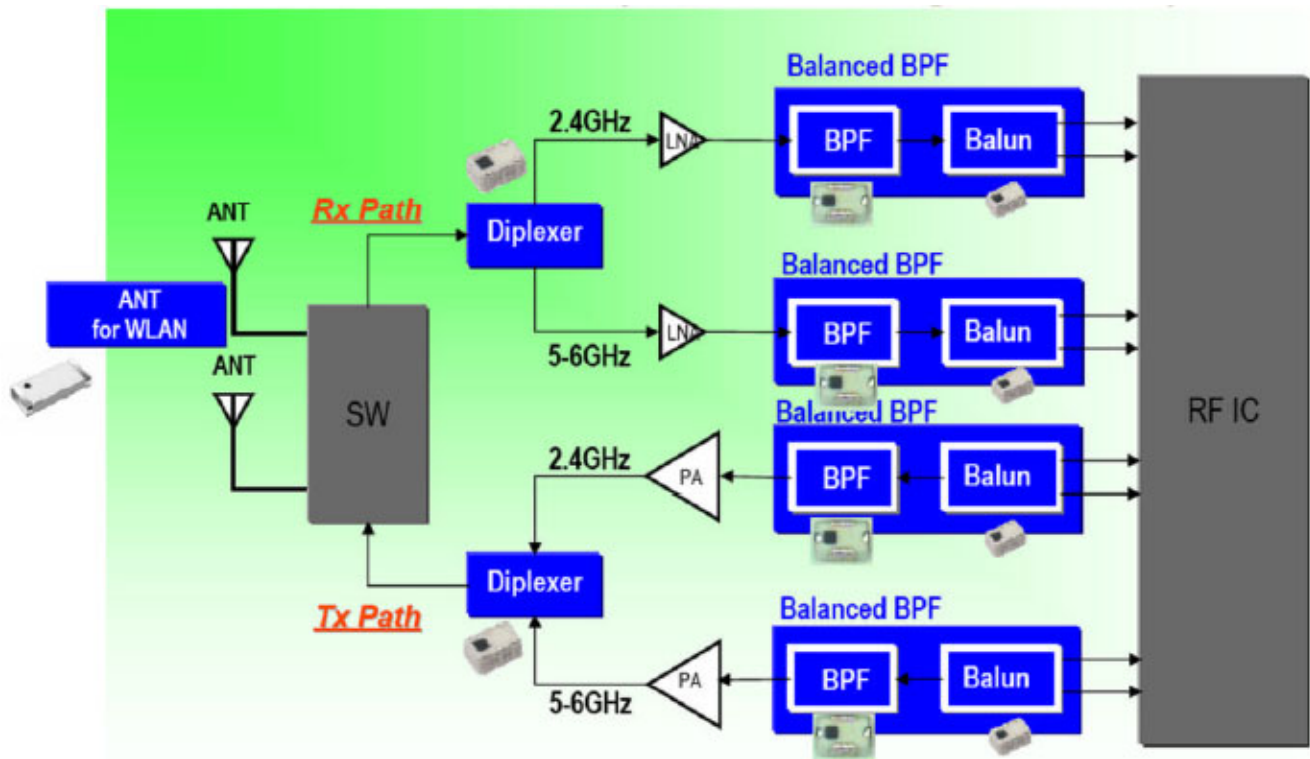

Please contact TDK for evaluation samples and detailed specifications.

Diplexer for 2.4GHz & 5GHz

Start Frequency MHz	Stop Frequency MHz	Ins. Loss dB (MAX)	Start Frequency MHz	Stop Frequency MHz	Insertion Loss dB (MAX)	Size mm (typ.)	Part Number
2300	2500	0.65	4900	5950	1.4	2.0x1.25x0.95	DPX205950DT-9008A1
2300	2500	0.65	4900	5950	1.4	2.0x1.25x0.95	DPX205950DT-9018A1
2400	2500	0.5	4900	5850	0.75	2.0x1.25x0.95	DPX205850DT-4027B1

Multilayer Band Pass Filter for 2.4GHz

Start Frequency MHz	Stop Frequency MHz	Ins. Loss dB (MAX)	Attenuation (MIN.)						Size mm (typ.)	Part No.
			MHz	dB	MHz	dB	MHz	dB		
2400	2500	1.2	915	35	1910	35	4800	30	2.5X2.0X0.9	DEA252400BT-2027A1
2300	2500	1.4	915	35	1910	35	4800	30	2.5X2.0X0.9	DEA252450BT-2030A1
2400	2500	1.5	915	35	2100	20	4800	23	2.5X2.0X0.9	DEA252450BT-2031A1
2400	2500	2.1	915	45	2170	20	4800	30	2.5X2.0X0.9	DEA252450BT-2024C1
2400	2500	3.2	800	40	2170	23	4800	25	2.0X1.2X0.65	DEA252450BT-2068A1
2300	2500	3.0	960	50	1990	48	2170	22	2.5X2.0X0.9	DEA252450BT-2024C2
2400	2500	3.0	960	50	1990	40	2170	33	2.5X2.0X0.9	DEA252450BT-2024D4
2400	2500	1.5	1900	30					2.5X1.2X0.95	DEA252450BT-1251A1
2400	2500	1.5	1300	25	3600	30	4800	34	2.0X1.2X0.9	DEA252450BT-1213C1
2400	2500	2.9	960	40	2170	16	4800	30	2.0X1.2X0.65	DEA252450BT-2038A5
2300	2500	2.0	915	25	1910	25	4800	20	1.6X0.8X0.6	DEA162450BT-1241A1
2400	2500	2.0	915	25	1910	20	4800	20	1.6X0.8X0.55	DEA162450BT-1247B1
2400	2500	2.5	915	25	1910	20	4800	25	1.6X0.8X0.55	DEA162450BT-1247C1
2400	2500	3.0	1250	30	1900	20	4800	25	1.6X0.8X0.6	DEA162450BT-1210A1

Low Pass Filter

Start Frequency MHz	Stop Frequency MHz	Ins. Loss dB (MAX)	Attenuation (MIN.)						Size mm (typ.)	Part No.
			MHz	dB	MHz	dB	MHz	dB		
2400	2500	0.42	4800	25	5000	25	7200	18	1.6X0.8X0.6	DEA162500LT-1212A1
2300	2500	0.48	4800	35	5000	35	7200	25	1.6X0.8X0.6	DEA162500LT-1217A1

High Pass Filter

Start Frequency MHz	Stop Frequency MHz	Ins. Loss dB (MAX)	Attenuation (MIN.)						Size mm (typ.)	Part No.
			MHz	dB	MHz	dB	MHz	dB		
2400	2484	0.75	920	25	1790	17	1915	20	2.0X1.2X1.0	DEA202484HT-8002A1
2400	2500	1.4	920	25	1790	18	1915	18	1.6X0.8X0.6	DEA162400HT-8004B1

Sample Specification : DEA252450BT-2024C2

Mechanical Dimensions (unit: mm)

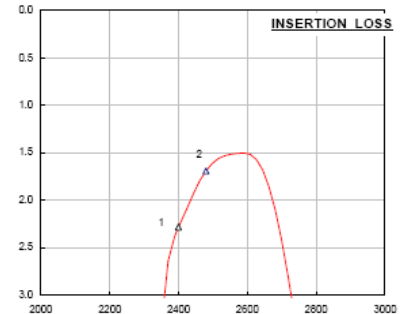
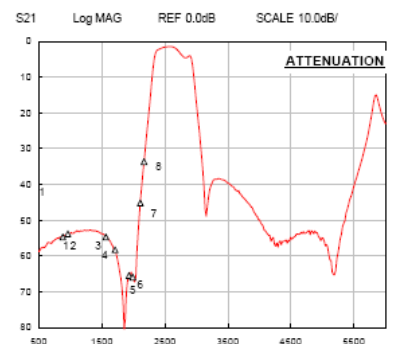
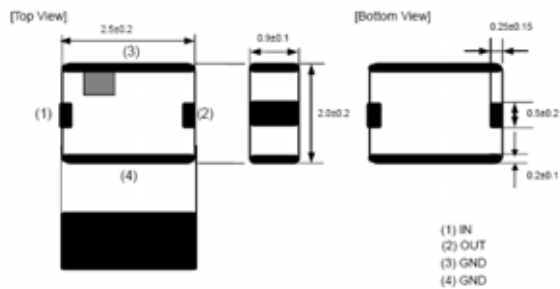

Electrical Characteristics at 25deg C

No.	Parameter	Freq. (MHz)	Specification			Unit
			Min.	Max.	TYP	
1	Insertion Loss	2400-2480	—	3.0	2.29	dB
2	Return Loss	2400-2480	10.0	—	13.7	dB
3	Attenuation	880-960	50.0	—	53.8	dB
4	Attenuation	1565-1585	50.0	—	54.7	dB
5	Attenuation	1710-1880	48.0	—	58.3	dB
6	Attenuation	1930-1990	48.0	—	65.5	dB
7	Attenuation	2110-2170	22.0	—	33.6	dB

Multilayer Band Pass Filter for 5GHz (Wide Band)

Start Frequency MHz	Stop Frequency MHz	Ins. Loss dB (MAX)	Attenuation (MIN.)						Size mm (typ.)	Part No.
			MHz	dB	MHz	dB	MHz	dB		
5150	5900	2.2	3450	35					1.6X0.8X0.6	DEA165487BT-1202
5150	5900	1.5	3450	35					2.0X1.2X0.9	DEA205437BT-1200
4900	5950	1.5	3450	25	9800	17			2.0X1.2X0.9	DEA205425BT-1209B2
4900	5950	2.0	3300	40	4000	25	7300	14	2.0X1.2X0.95	DEA205425BT-2028A4
4900	5850	1.2	824	50	1910	50	9800	15	2.5X2.0X0.9	DEA255375BT-2076A1
4940	5850	3.5	2700	40	4650	24	7250	39	2.5X2.0X1.0	DEA255395BT-2065D2

Low Pass Filter

Start Frequency MHz	Stop Frequency MHz	Ins. Loss dB (MAX)	Attenuation (MIN.)						Size mm (typ.)	Part No.
			MHz	dB	MHz	dB	MHz	dB		
5125	5725	1.5	6800	12	10250	25	11450	25	1.6X0.8X0.8	DEA165725LT-1196A2
4900	5950	0.7	9800	20	11900	30			1.6X0.8X0.8	DEA165850LT-1197B2

Balanced Output Multilayer Band Pass Filter

Start Frequency MHz	Stop Frequency MHz	Ins. Loss dB (MAX)	Bal. Imped. ohm	Attenuation (MIN.)				Size mm (typ.)	Part No.
				MHz	dB	MHz	dB		
4900	5950	2.8	100	4000	30	8000	20	2.0X1.5X1.3	DEA215425BT-7075C2

Sample Specification : DEA255425BT-2028A4

Electrical Characteristics at 25deg C

No.	Parameter	Freq. (MHz)	Specification			Unit
			Min.	Max.	TYP	
1	Center Frequency	5425	—	—	—	—
2	Insertion Loss	4900-5950	—	1.6	2.0	dB
3	Insertion Loss -40 ~ +85 °C	4900-5950	—	1.9	2.3	dB
4	Return Loss	4900-5950	9	11	—	dB
5	Attenuation	1280-3300	40	50	—	dB
6	Attenuation	3300-4000	25	33	—	dB
7	Attenuation	4375-4465	7	12	—	dB
8	Attenuation	7300-8930	14	18	—	dB
9	Attenuation	9800-11900	25	38	—	dB

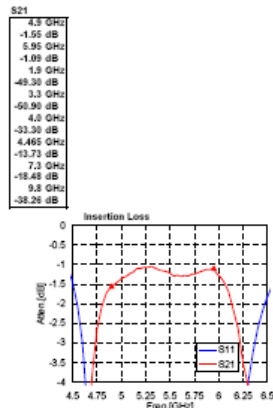
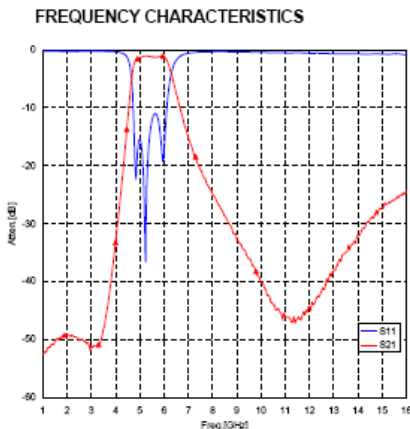

MECHANICAL DIMENSIONS

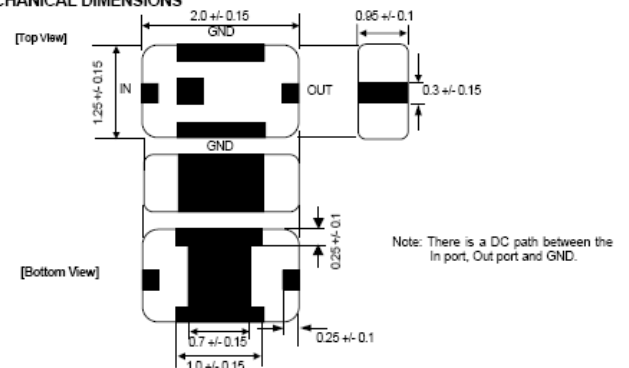

Balun Transformers for 2.4GHz

Start Frequency MHz	Stop Frequency MHz	Ins. Loss dB (MAX)	Bal. lmed. ohm	Amp. Bal dB (MAX)	Phase Bal Deg	Size mm (typ.)	Part No.
2400 (2300)	2500	1.2	50	2.0	180+/- 10	2.0X1.2X0.95	HHM157(A2)
2400 (2300)	2500	1.0	75	1.5	180+/- 10	2.0X1.2X0.95	HHM1541E1(E2)
2400 (2300)	2500	1.0	100	2.0	180+/- 10	2.0X1.2X0.95	HHM1520(A2)
2400 (2300)	2500	1.0(1.1)	200	2.0	180+/- 10	2.0X1.2X0.95	HHM1521(A2)
2400	2500	1.2	50	2.0	180+/- 10	1.6X0.8X0.6	HHM1711D1
2400	2500	1.2	100	2.0	180+/- 10	1.6X0.8X0.6	HHM1711D1
2400	2500	1.0	100	1.5	180+/- 10	1.6X0.8X0.6	HHM1711N1
2400	2500	1.2	150	2.0	180+/- 10	1.6X0.8X0.6	HHM1712D1
2400	2500	1.2	200	1.7	180+/- 10	1.6X0.8X0.6	HHM1713E2
2400	2500	1.0	50	2.0	180+/- 10	1.0X0.5X0.45	HHM1902A1
2400	2500	1.0	100	2.0	180+/- 10	1.0X0.5X0.45	HHM1903A1

Balun Transformers for 5GHz (Wide Band)

Start Frequency MHz	Stop Frequency MHz	Ins. Loss dB (MAX)	Bal. lmed. ohm	Amp. Bal dB (MAX)	Phase Bal Deg	Size mm (typ.)	Part No.
5150	5875	1.0	100	2.0	180+/- 10	2.0X1.2X0.95	HHM1562B
4900	5950	1.0	100	2.0	180+/- 10	2.0X1.2X0.95	HHM1570B1
4900	5950	1.2	50	1.0	180+/- 10	1.6X0.8X0.6	HHM1733B1
4900	5950	1.0	100	2.0	180+/- 10	1.6X0.8X0.6	HHM1732B1
4900	5950	1.2	200	1.5	180+/- 10	1.6X0.8X0.6	HHM1752A2

Balun Transformers for Local (802.11a)

Start Frequency MHz	Stop Frequency MHz	Ins. Loss dB (MAX)	Bal. lmed. ohm	Amp. Bal dB (MAX)	Phase Bal Deg	Size mm (typ.)	Part No.
3400	4010	1.2	50	1.5	180+/- 10	2.0X1.2X0.95	HHM1545
3400	4010	0.8	100	1.5	180+/- 10	2.0X1.2X0.95	HHM1594A1
3400	3925	1.2	200	1.0	180+/- 10	1.6X0.8X0.6	HHM1548E1

TDK RF components can be used in different architectures (see Example 1 & 2). Please refer to page 5 for 2.4GHz BPF information and page 7 for 2.4GHz balun information.

TDK RF Components are recommended by leading Bluetooth chipset manufacturers.

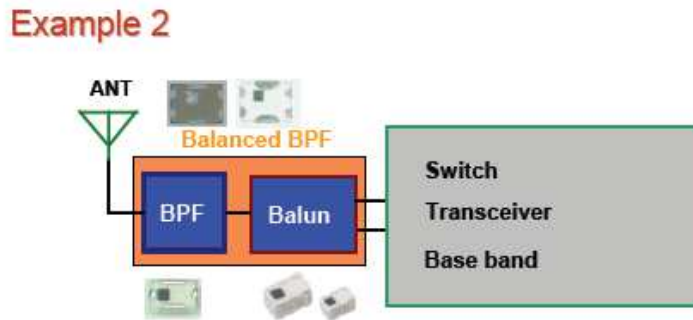
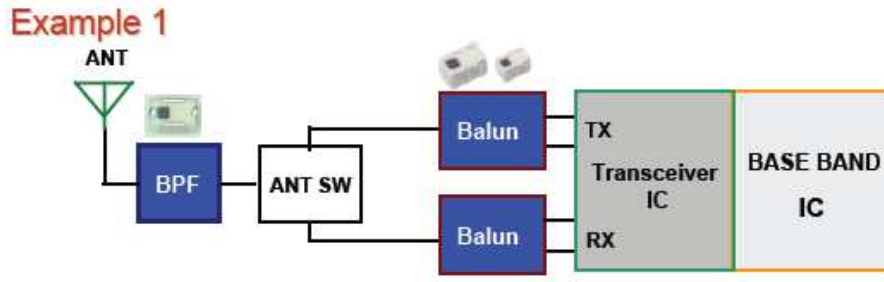

TDK has designed a series of Balanced Output BPF's that are optimized to match the impedance requirements of Bluetooth IC's.

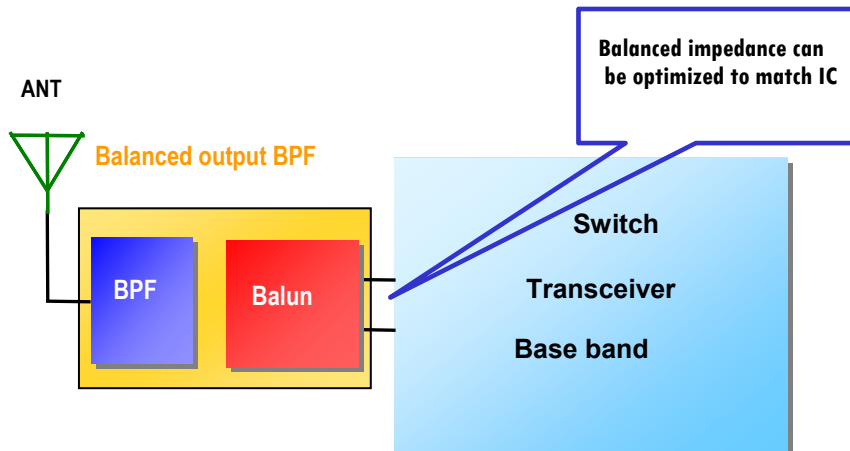

MULTILAYER Band Pass Filter (Balance output Type)
P/N: DEA 252450BT-7022B1
For Bluetooth and 2.4GHz W-LAN

MECHANICAL DIMENSIONS
 Top View

PIN CONFIGURATION

PIN ASSIGNMENT	PIN No.
Unbalanced	1
Balanced	4,5
GND	3,6
DC feed or RF GND	2

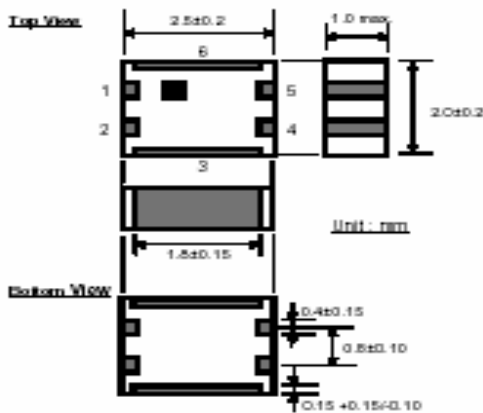

Electrical Characteristics

Parameter	Specification	Typical Value	Unit
Frequency Range (Pass Band)	2400-2500	—	MHz
Unbalanced Port Characteristics Impedance	50 (nominal)	—	Ω
Balanced Port Characteristics Impedance	100 (nominal)	—	Ω
Unbalanced Port Return Loss	9.5 min	—	dB
Insertion Loss (Pass Band)	+25°C	3.0 max	2.7
	-40 — +85°C	3.0 max	3.0
Ripple (Pass Band)	1.0 max	0.2	dB
Attenuation	880-960MHz	48 min	52
	1710-1880MHz	45 min	51
	1880-1980MHz	40 min	54
	2110-2170MHz	25 min	33
	4800-5000MHz	30 min	38
Amplitude Impedance at Balanced Port	1.0 max	-0.2	dB
Phase Differences at Balanced Port	+25°C	180±8	183
	-40 — +85°C	180±10	—

For 2.4GHz
Multilayer Balanced Band Pass Filter

Start Frequency MHz	Stop Frequency MHz	Ins. Loss dB (MAX)	Bal. Imped. ohm	Attenuation (MIN.)				Size mm (typ.)	Part No.
				MHz	dB	MHz	dB		
2400	2500	1.7	50	1910	35	4800	30	2.5X2.0X0.9	DEA252450BT-7014D1
2400	2500	1.9	100	1910	35	4800	30	2.5X2.0X0.9	DEA252450BT-7012D1
2400	2500	2.4	50	1920	20	4800	23	2.5X2.0X0.9	DEA252450BT-7001B1
2400	2500	3.0	100	2170	20	4800	30	2.5X2.0X0.9	DEA252450BT-7022B1
2402	2480	3.5	30+j30	2170	23	4800	25	2.5X2.0X0.95	DEA252441BT-7053D2
2400	2500	3.6	34+j72	2170	48	2170	22	2.5X2.0X0.9	DEA252450BT-7035B2
2400	2500	2.7	50	2170	40	2170	33	2.1X1.50X0.9	DEA212450BT-7031A1
2400	2500	3.6	55+j50	2170				2.1X1.50X0.9	DEA212450BT-7043C1
2402	2480	CSR BC4	CSR BC4	Match to CSR BC4				2.1X1.25X0.6	DEA202450BT-7041E1
2400	2500	3.4	55+j50	2168	20	4800	26	2.1X1.25X0.9	DEA202450BT-7089C2
2400	2500	3.5	100	2170	25			2.1X1.25X0.7	DEA202450BT-7054B1
2400	2500	3.5	34+j72	2170	17	4800	25	2.1X1.25X0.95	DEA202450BT-7077A1

TDK's newest line-up of RF Components for WiMAX applications can be used in both client and base station designs. These components have been developed to work in the 2.3GHz, 2.5GHz, 3.5GHz and 700MHz bands.

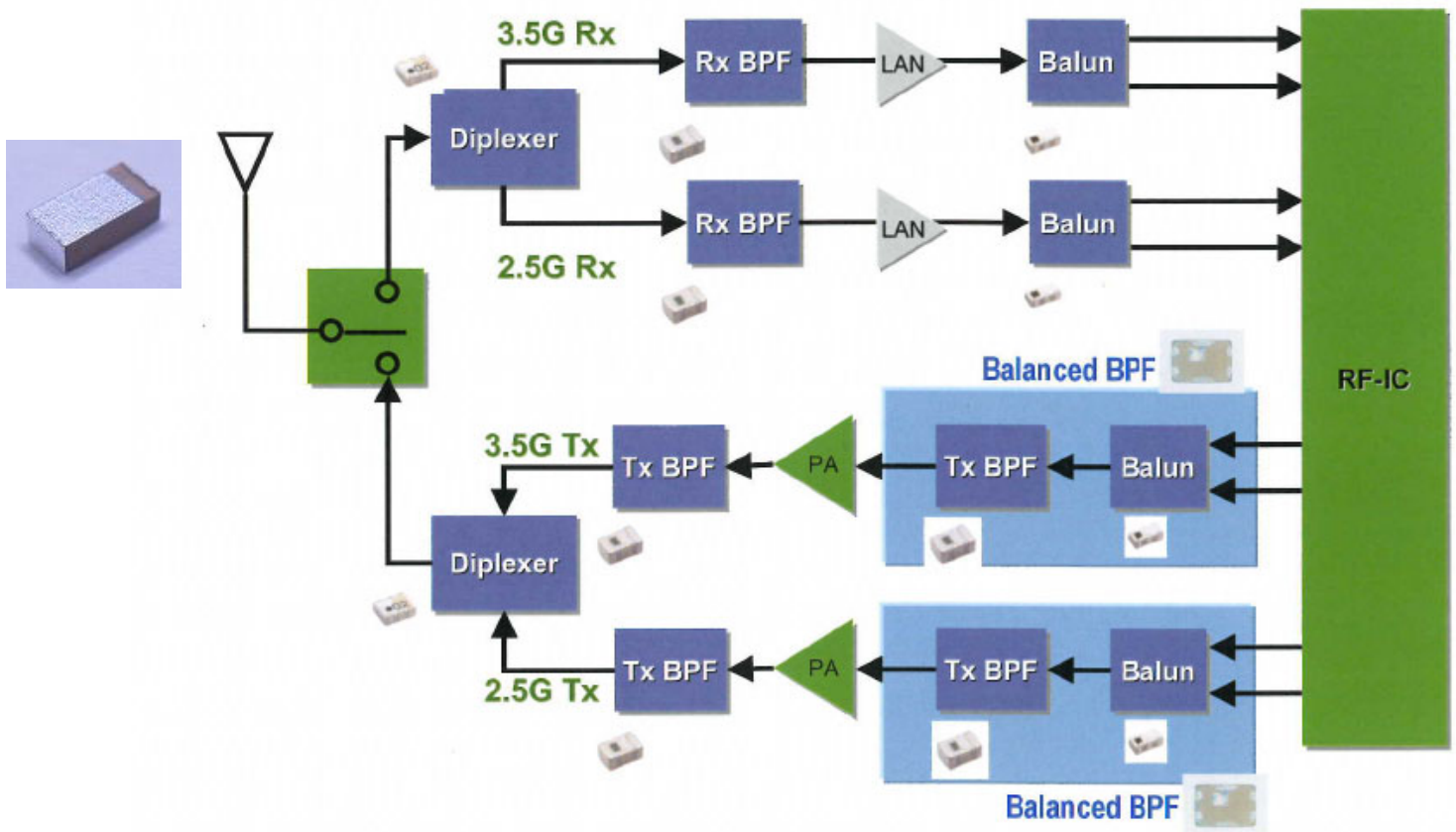

Couplers 2.3GHz, 2.5GHz & 3.5GHz

Start Frequency MHz	Stop Frequency MHz	Ins. Loss dB (MAX)	Coupling dB	Isolation dB	V.S.W.R	Size mm (typ.)	Part No.
2300	2700	0.55	-12 +/- 1.5	20 Min.	1.5	1.6X0.8X0.6	HHM2241SA3
2300	2700	0.40	-20 +/- 1.5	32 Min.	1.3	1.6X0.8X0.6	HHM2233SA7
2300	2700	0.40	-16 +/- 1.5	25 Min.	1.3	1.6X0.8X0.6	HHM2245SA3
3400	3600	0.35	-18 +/- 1.5	23 Min.	1.3	1.6X0.8X0.6	HHM2261SA1

Balun Transformers for 2.3GHz, 2.5GHz, 3.5GHz

Start Frequency MHz	Stop Frequency MHz	Ins. Loss dB (MAX)	Bal. Imed. ohm	Amp. Bal dB (MAX)	Phase Bal Deg	Size mm (typ.)	Part No.
2300	2700	1.2	50	1.5	180+/- 10	1.6X0.8X0.6	HHM1710J1
2300	2700	1.2	100	1.5	180+/- 10	1.6X0.8X0.6	HHM1711E1
2500	2700	0.8	100	2.2	180+/- 10	1.6X0.8X0.6	HHM1711K1
2500	2700	0.8	100	2.2	180+/- 10	1.6X0.8X0.6	HHM1791A1
3300	3900	1.2	50	1.5	180+/- 10	1.6X0.8X0.6	HHM1727D1
3300	3900	1.0	100	1.2	180+/- 10	1.6X0.8X0.6	HHM1715E1

Multilayer Ceramic Band Pass Filter

Start Frequency MHz	Stop Frequency MHz	Ins. Loss dB (MAX)	Attenuation (MIN.)						Size mm (typ.)	Part No.
			MHz	dB	MHz	dB	MHz	dB		
2300	2690	1.8	915	30	1800	19	4800	43	2.0X1.25X.95	DEA202495BT-124B2
2496	2690	2.5	960	50	2125	28	4800	33	2.5X2.0X1.0	DEA252593BT-2074A3
2496	2690	1.5	915	50	2125	31	4800	45	2.5X2.0X1.0	DEA252593BT-2079A1
3300	3900	2.2	915	27	2170	27	4800	15	2.0X1.25X.95	DEA203600BT-1230B2

Low Pass Filter

Start Frequency MHz	Stop Frequency MHz	Ins. Loss dB (MAX)	Attenuation (MIN.)						Size mm (typ.)	Part No.
			MHz	dB	MHz	dB	MHz	dB		
2400	2700	0.4	4800	26	5350	26	7200	23	1.6X0.8X0.6	DEA162700LT-5014A1
3400	3600	0.5	5000	10	5000	30	7200	26	1.6X0.8X0.6	DEA163600LT-5017A1

Multilayer Ceramic Balanced Band Pass Filter

Start Frequency MHz	Stop Frequency MHz	Ins. Loss dB (MAX)	Bal. Imped. ohm	Attenuation (MIN.)				Size mm (typ.)	Part No.
				MHz	dB	MHz	dB		
2300	2400	2.5	100	1910	39	4800	36	2.5X2.0X1.0	DEA252350BT-7093A1
2300	2690	2.8	50	1910	13	4800	40	2.5X2.0X0.9	DEA212495BT-7055A2
2300	2690	2.5	100	1910	18	4800	23	2.5X2.0X0.9	DEA212495BT-7097A2
3300	3900	2.5	50	1910	49	5000	17	2.5X2.0X0.9	DEA213600BT-7095A2
3300	3900	2.5	100	1910	30	4800	13	2.5X2.0X0.95	DEA213600BT-7095A1

Diplexer

Start Frequency MHz	Stop Frequency MHz	Ins. Loss dB (MAX)	Start Frequency MHz	Stop Frequency MHz	Ins. Loss dB (MAX)	Size mm (typ.)	Part No.
2300	2690	1.6	3300	3900	1.6	2.0X1.25X0.60	DPX203900DT-9019A1
2300	2690	1.9	3300	3900	1.7	3.2X2.5X1.2	DPX322600DT-0003
2500	2690	1.2	3300	3900	1.3	3.2X2.5X1.2	DPX323600DT-0004

Ceramic Block Band Pass Filter for 2.3GHz, 2.5GHz, 2.5GHz & 3.5GHz

Start Frequency MHz	Stop Frequency MHz	Ins. Loss dB (MAX)	Attenuation (MIN.)				Size mm (typ.)	Part No.		
			MHz	dB	MHz	dB				
2490	2710	1.2	1800	44	3400	42	4400	38	8.0X3.0X3.5	S0486A
3230	3410	1.2	1800	56	2462	45	4400	37	8.0X3.0X3.5	S0486B
3390	3660	1.2	1800	58	2462	45	4400	40	8.0X3.0X3.5	S0486C
3590	3810	1.2	1800	58	2462	45	4400	48	8.0X3.0X3.5	S0486D

Circulators for 2.3GHz, 2.5GHz, 2.5GHz & 3.5GHz

Start Frequency MHz	Stop Frequency MHz	Ins. Loss dB (MAX)	Isolation dB (min)	V.S.W.R. 0=50 ohm (Max)	Max. Handling Power (W)	Size mm (typ.)	Part No.
2500	2700	0.4	20.0	1.3	20.0	20X20X8.5	CU1S2001AC-2600
2900	3100	0.4	20.0	1.25	20.0	20X20X11.5	CU1S2002AC-3000
3400	3600	0.5	18.0	1.3	20 (Ave)	20X20X8.0	CU1S2001AC-3500

Ceramic Block Band Pass Filter for 700MHz

Start Frequency MHz	Stop Frequency MHz	Ins. Loss dB (MAX)	Attenuation (MIN.)				Size mm (typ.)	Part No.		
			MHz	dB	MHz	dB				
700	750	2.2	650	30	800	25	1000	40	13.2X10X4	S0465D

Front-End Module for 802.16e Mobile WiMAX Applications

- Operating Frequency: 2.5 to 2.7 GHz
- Integrated 25dB Attenuator
- Integrated Output Power Detector
- 50 W Matched RF Ports
- Low Profile LGA Package for Mobile Application: 6.0 x 5.6 x 1.2 mm
- Supports 1X2 (1 TX & 2 RX) Configuration
- Multi-Chip Technology: Integrated Power Amplifier and T/R Switch
- Utilizes TDK's LTCC Technology to embed all required filtering

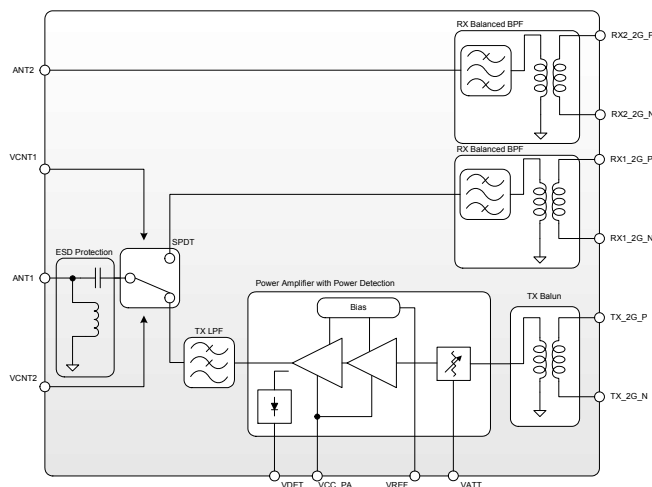
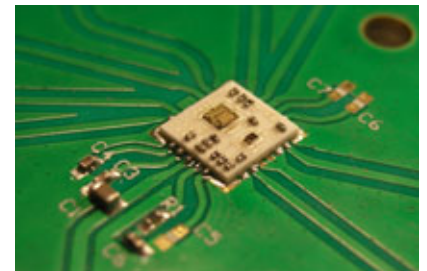

TDK Band Pass Filters for UWB Applications

TDK Band Pass Filters for UWB are available in a performance and a reduced footprint version. The performance version is for applications requiring maximum attenuation at 2.4GHz and 5GHz applications. Reduced footprint series is for applications requiring minimum attenuation.

DEA-3002B1



[MECHANICAL DIMENSIONS]

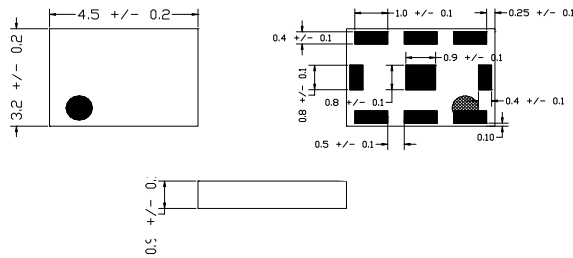

[MECHANICAL DIMENSIONS]

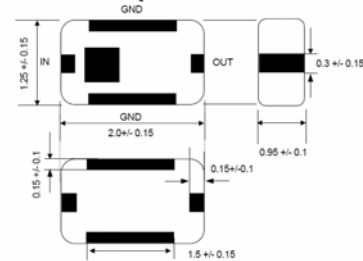

Electrical Characteristics at (T=30°C to 85°C, Z_L=50Ω)

Parameter	Freq. (MHz)	Specification			Unit
		Min.	Max.	TYP	
Insertion Loss (T=25°C)	3168-4752		1.9		dB
Insertion Loss (T=30°C to 85°C)	3168-4752		2.2		dB
Input Return Loss	3168-4752	10			dB
Attenuation	DC-2200	30			dB
Attenuation	2200-2500	26			dB
Attenuation	5151-5300	23			dB
Attenuation	5300-7000	26			dB
Attenuation	7000-14000	15			dB

Frequency Characteristic

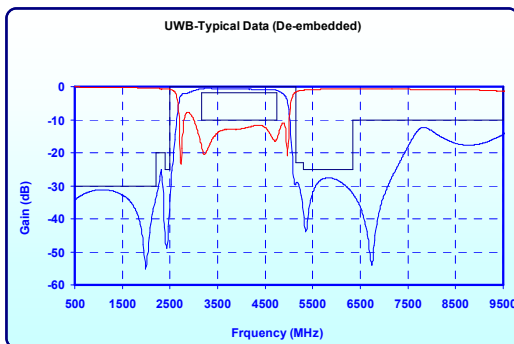

Electrical Characteristics Ta=25°C

No.	Parameter	Freq. (MHz)	Specification	Unit
1	Insertion Loss	3.168-4.752	2.0 max	dB
2	Return Loss	3.168-4.752	10 min	dB
3	Attenuation	DC-2.4	25 min	dB
4	Attenuation	2.5	25 min	dB
5	Attenuation	5.15-7.0	20 min	dB
6	Attenuation	7.0-14.5	15 min	dB

Frequency Characteristic

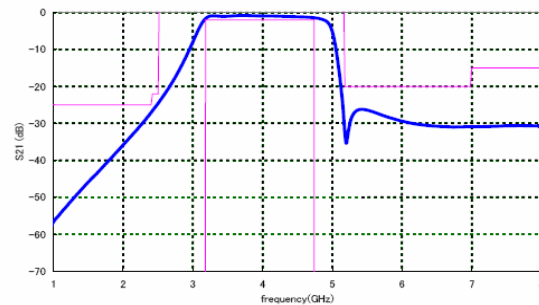

Please contact TDK for full spec sheets and application notes.

TDK Baluns for UWB Applications

Balun Example : unbalanced 50Ω to balanced 100Ω

HHM 1583B1



Pin Configuration:

1. Unbalanced Port
2. GND or DC feed
3. Balanced Port
4. Balanced Port
5. GND
6. N.C.

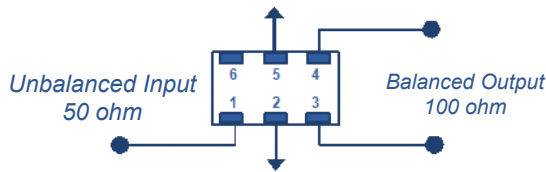

Mechanical Dimensions

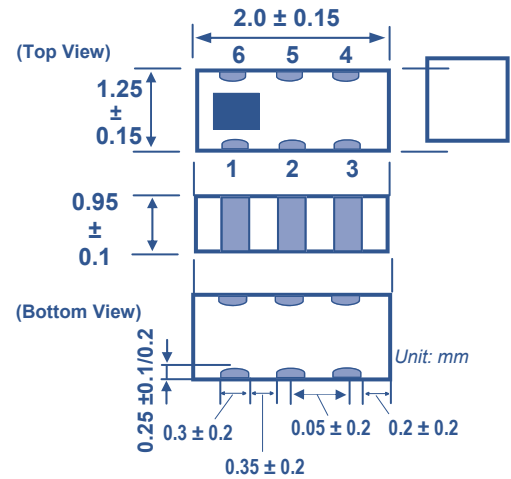

Return Loss

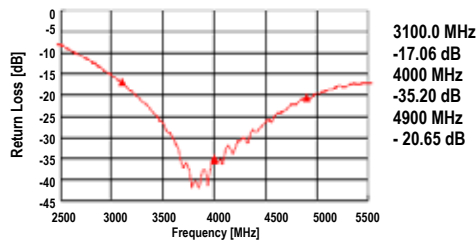

Amplitude Balance

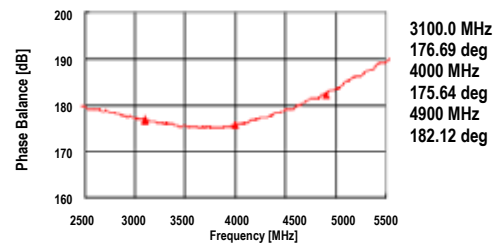
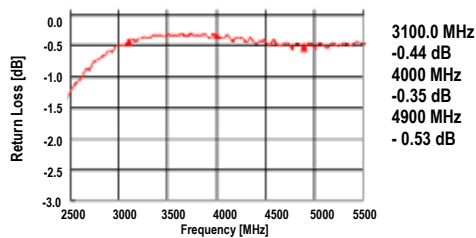
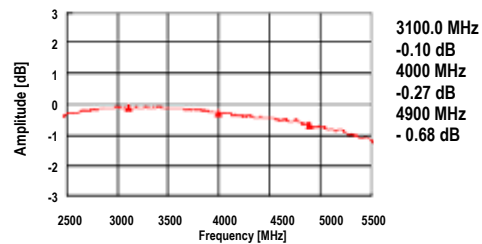

Electrical Characteristics at 25 degC

No.	PARAMETER	FREQ (MHz)	SPEC		UNIT
			Min.	Max.	
1	Insertion Loss (Lo-Band Port)	2300-2500	-	1.2	dB
2	Insertion Loss (Hi-Band Port)	3168-4572	-	1.7	dB
3	Return Loss (ANT Port)	2300-2500	10.0	-	dB
4	Return Loss (ANT Port)	3168-4572	4.5	-	dB
5	Attenuation (Hi-Band Port)	2300-2500	20.0	-	dB
6	Attenuation (Lo-Band Port)	3168-4572	20.0	-	dB

TDK Balanced Antenna for Use in UWB Applications

TDK has developed a multilayer chip antenna with a patented balanced radiator structure. The antenna's unique structure allows it to maintain similar performance regardless of ground plane size. Unlike monopole antennas, which are dependent on ground plane size, this antenna has been designed for ease of integration in various applications without the worry of complex board re-designs. It is ideal for use in CardBus, CompactFlash or USB designs.

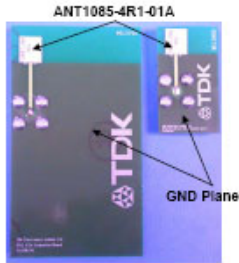

There is a significant difference in ground plane size but almost no difference in VSWR results. The antenna bandwidth is not detuned by changing the ground plane size.

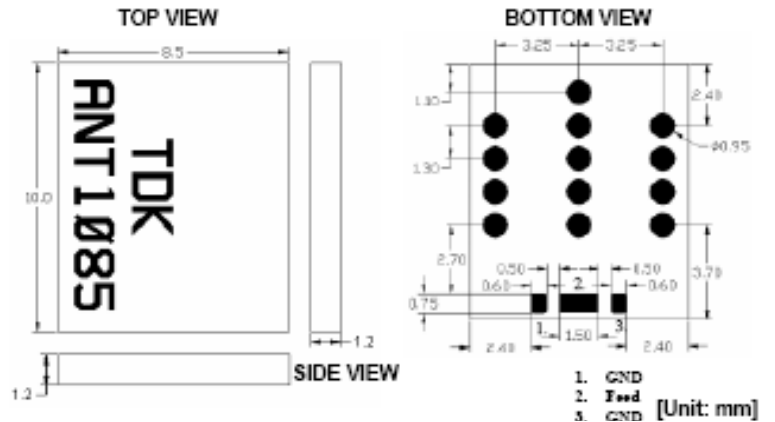
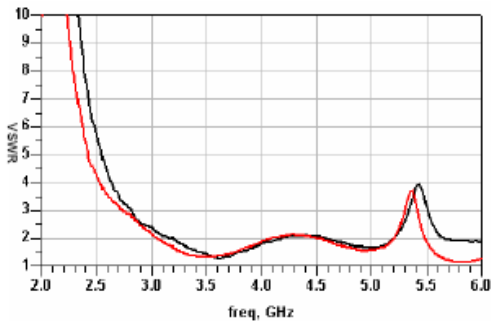

Electrical Specifications

Parameter	Value	Unit
Operation Frequency	3.1–5.2	GHz
Polarization	Linear (Mixed)	None
Antenna Gain	2.0 (typ.)	dBi
Impedance	50	ohm
VSWR	3 (Max)	None

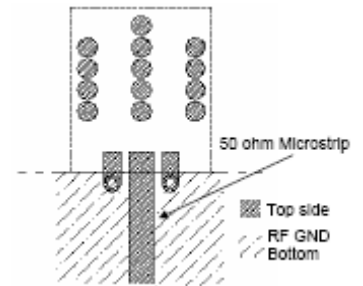

Radiation Patterns

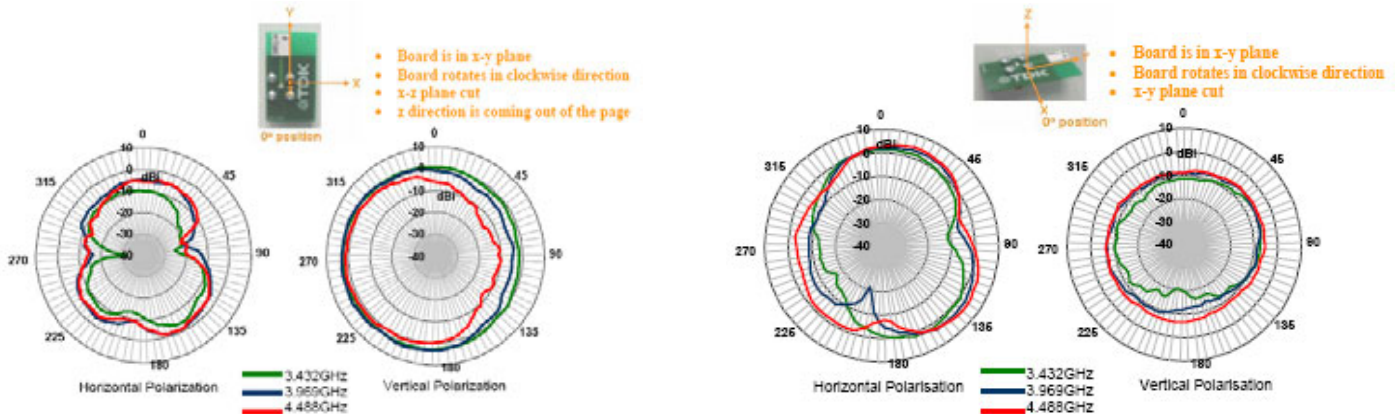

Contact TDK for full spec sheets and application notes

TDK Compliance Test Services & Expertise For UWB Wireless Systems

TDK's advanced wireless radio testing services have been used by leading UWB chipset companies for both, FCC compliance and UWB transceiver development. TDK provides complete regulatory compliance testing, report preparation and submission.

Let TDK work with you to develop test and measurement solution for your Certified Wireless USB products.



TDK supports the complete FCC submission process.

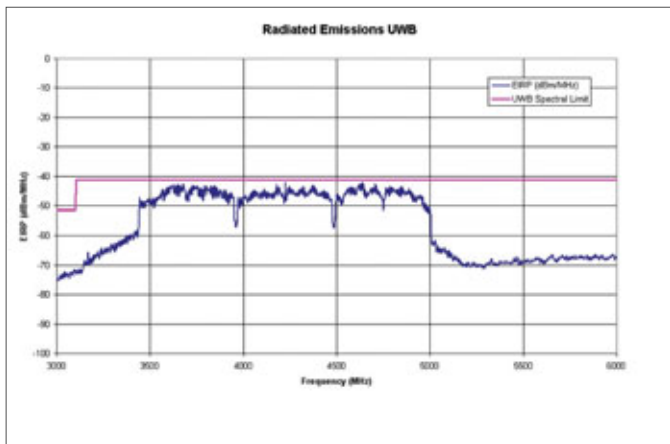

FCC granted UWB transceiver
General Atomics: AEVK-1
Wisair: DV9100

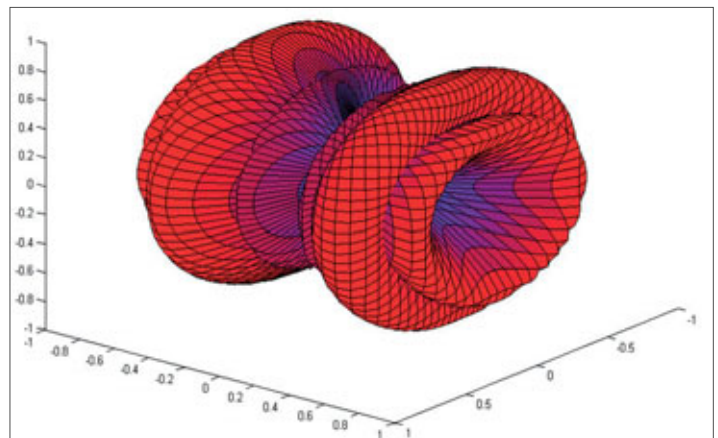

3D radiation pattern of typical dipole antenna.

UWB transceiver testing requires measurements spanning wide frequency and dynamic ranges. TDK provides FCC compliance testing using specialized instrumentation and an optimized facility to provide test reports.

Antenna performance is an important part of the UWB solution. TDK performs antenna analysis for high performance Certified Wireless USB transceiver development.

Wireless Ecosystem

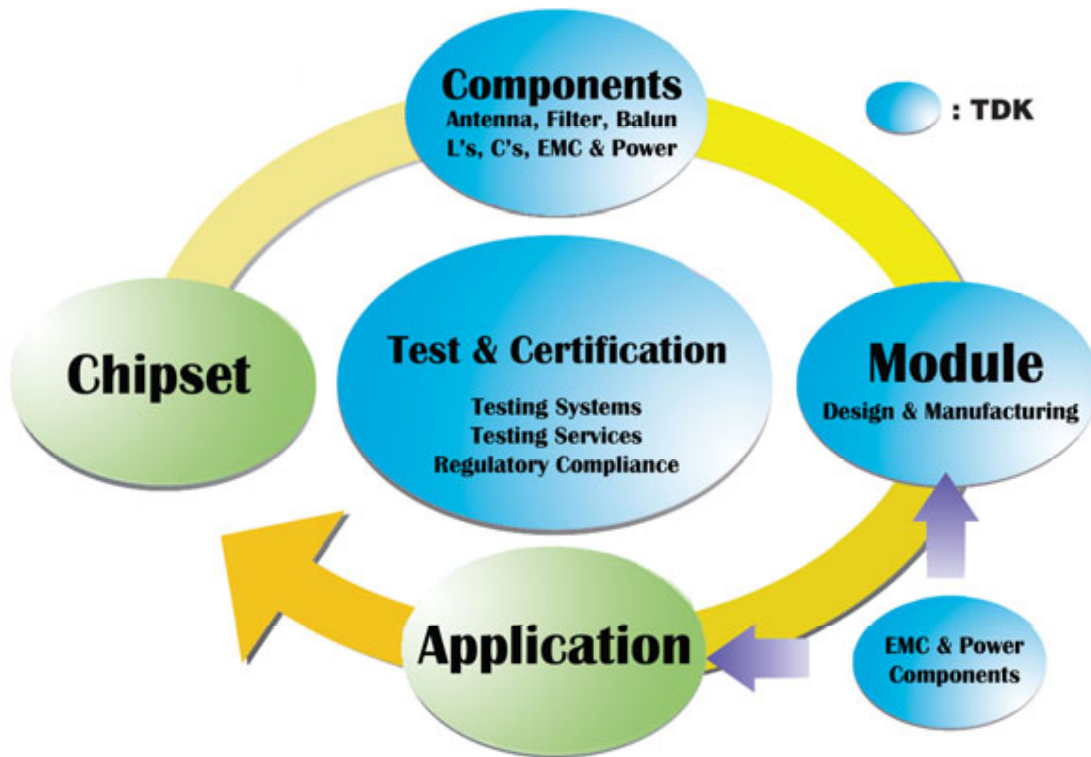

The Wireless Ecosystem brings together various technologies required to develop and manufacture advanced wireless products, systems and equipment. TDK provides key building blocks necessary to bring Certified Wireless USB, High Data Rate Bluetooth and other UWB products to market.

TDK components & services for UWB Technology include:

- ◆ Antennas
- ◆ Baluns
- ◆ Band Pass Filters
- ◆ Diplexers
- ◆ EMI Filters
- ◆ Test Systems
- ◆ Test Services
- ◆ Anechoic Chambers
- ◆ Inductors
- ◆ Capacitors

TDK Test & Measurement Solutions for Your UWB Wireless System

UWB-EMC Test System

- UWB-EMC test system (for test and measurement of radiated emission from UWB radio) Ultra wide frequency measurement required FCC compliance test.
- Ultra wide dynamic ranges for UWB test which radiate very low power emission.
- TDK's original anechoic chamber, antenna, and software based test system.
- Possible to upgrade your EMC test systems to state-of-the-art UWB-EMC test system.



- 3m chamber (FCC comply, 9x6x5.7m)
- Compact chamber (FCC comply, 7x4x3m)
- TDK's original hybrid anechoic chamber

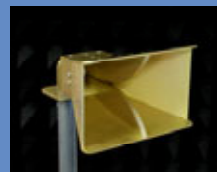

- Test system for measurement up to 40GHz
- Hardware, software, & training are included

TDK Offers Complete Turnkey Systems of Anechoic Chambers

TDK offers a "single vendor" solution for test facilities by offering both systems and test chambers. Offering a TDK line of turnkey 3 meter, 5 meter, 10 meter, and compact anechoic chamber solutions based on top-performing TDK absorber technologies. Each facility is built with high-performance radio wave absorbing materials selected specifically to match your test requirements and manage the implementation of both systems and chambers to deliver a turnkey test facility that is tightly integrated.



Anechoic chambers for EMC Testing:

- 3m type (FCC comply, 9x6x5.7m) or compact type (FCC comply, 7x4x3m)
- TDK's high performance electromagnetic absorber material (IB-015 and IP-045 absorber)
- Automatically controlled turntable and antenna mast via optical fiber.
- Normalized Site Attenuation (NSA) measurement for compliance.

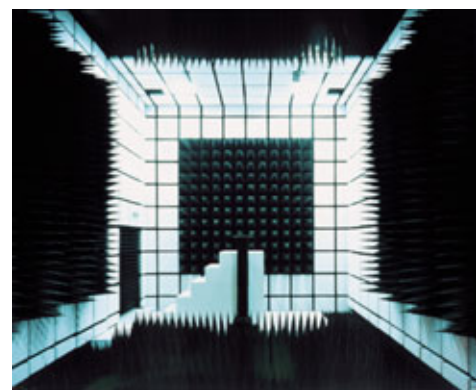

Anechoic Chamber for Antenna Testing

- Anechoic chamber (compact type, 7x4x4m)
- TDK's high performance electromagnetic absorber material (IS-060 absorber)
- TDK's original oblique incident absorber, IS-SM050, for exceptional absorption performance
- Quiet zone (QZ) measurement

Discover TDK Solutions



RF Components for Wireless Applications



For Samples, Datasheets and Additional Product Information on these and other TDK Wireless Solutions . . .

TDK Corporation of America

1221 Business Center Drive, Mount Prospect, IL 60056

Phone: +1 (847) 803-6100

Fax: +1 (847) 803-1125

Email: wirelessinfo@tdktca.com

Visit our website: www.component.tdk.com

D i s c o v e r T D K

www.component.tdk.com