



Chipsmall Limited consists of a professional team with an average of over 10 year of expertise in the distribution of electronic components. Based in Hongkong, we have already established firm and mutual-benefit business relationships with customers from,Europe,America and south Asia,supplying obsolete and hard-to-find components to meet their specific needs.

With the principle of “Quality Parts,Customers Priority,Honest Operation,and Considerate Service”,our business mainly focus on the distribution of electronic components. Line cards we deal with include Microchip,ALPS,ROHM,Xilinx,Pulse,ON,Everlight and Freescale. Main products comprise IC,Modules,Potentiometer,IC Socket,Relay,Connector.Our parts cover such applications as commercial,industrial, and automotives areas.

We are looking forward to setting up business relationship with you and hope to provide you with the best service and solution. Let us make a better world for our industry!



Contact us

Tel: +86-755-8981 8866 Fax: +86-755-8427 6832

Email & Skype: info@chipsmall.com Web: www.chipsmall.com

Address: A1208, Overseas Decoration Building, #122 Zhenhua RD., Futian, Shenzhen, China



DEMOAPEXSENSOR Usage

Altitude Pressure EXperimental (APEX) Sensor Board

by: John B. Young

INTRODUCTION

The DEMOAPEXSENSOR is an experimental sensor board focused on pressure with a variety of applications built into the demo. These include: Altimeter, Barometer, Barometer Alarm, Weather station, Waterlevel, Waterlevel Alarm, Tilt, Freefall, and Temperature Sensing. The board has been designed as a standalone board to be interfaced currently via an LCD display and menu buttons. The multiple functions of the Altitude Pressure EXperimental (APEX) Sensor board are possible with the use of Freescale's sensors. This kit has the following: MPL115A2, MPXM2102A, MPXV5004G pressure sensors with an MMA7361L accelerometer. The demo makes use of Freescale's Flexis MC9S08JM60 8-bit microcontroller. [Figure 1](#) is an image of the DEMOAPEXSENSOR with important items highlighted. Freescale's sensors are listed along with their associated application in [Table 1](#).

Table 1. On-Board Sensors

Device	Type of Sensor	Measurement Range of Sensor	Sensor Application	Interface Type
MPL115A	Pressure Absolute	50 - 115 kPa	Barometer/Altimeter	Digital I ² C/SPI
MPXM2102A	Pressure Absolute	0 - 100 kPa	Altimeter/Absolute Pressure	Analog
MPXV5004G	Pressure Gauge	0 - 4 kPa	Liquid Level Sensor	Analog
MMA7361L	Accelerometer	Selectable $\pm 1.5g$, $\pm 6g$	Acceleration, Tilt, Shock, Freefall	Analog

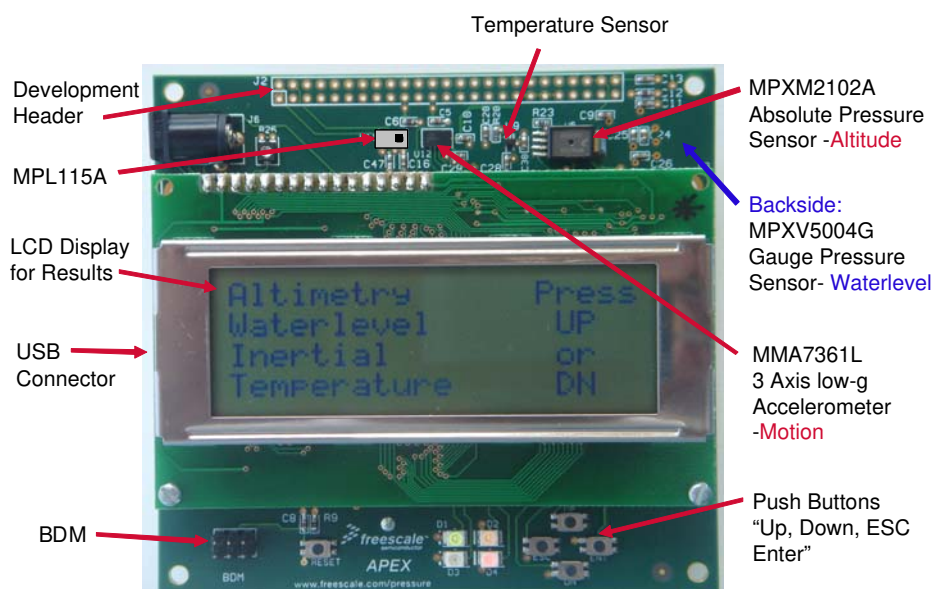

Figure 1. Basic Components of APEX Board

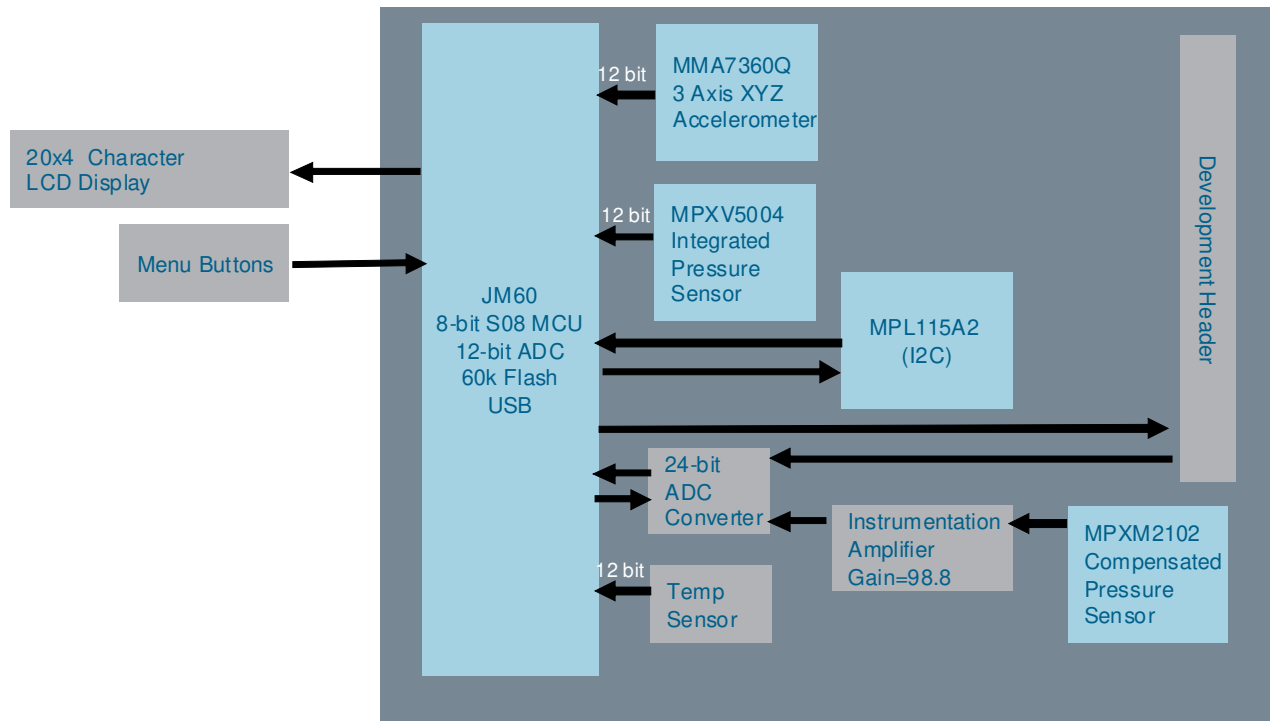

Figure 2. Simplified Block Diagram

Figure 2 is a simplified block diagram of the DEMOAPEXSENSOR. The sensors with analog outputs (Table 1) are sampled via the JM60 microcontroller's 12-bit ADC. The exception is the MPXM2102A absolute pressure sensor. This is used for altitude so it requires a high resolution sampling. It passes through an instrumentation amplifier and then is interfaced via an external 24-bit ADC chipset before communication via SPI to the JM60 MCU. The JM60 interfaces with the LCD screen and processes inputs by the user for the displayed output.

Several Algorithms are used to calculate functions on the DEMOAPEXSENSOR.

Information on implementing the MPL115A can be found in [AN3785, How to Implement the Freescale MPL115A Digital Barometer.](#)

Implementing the MPL115A as a barometer and altimeter can be found in [AN3914, Modern Altimeter and Barometer System using the MPL115A.](#)

More pressure sensor application notes can be found at: www.freescale.com/pressure.

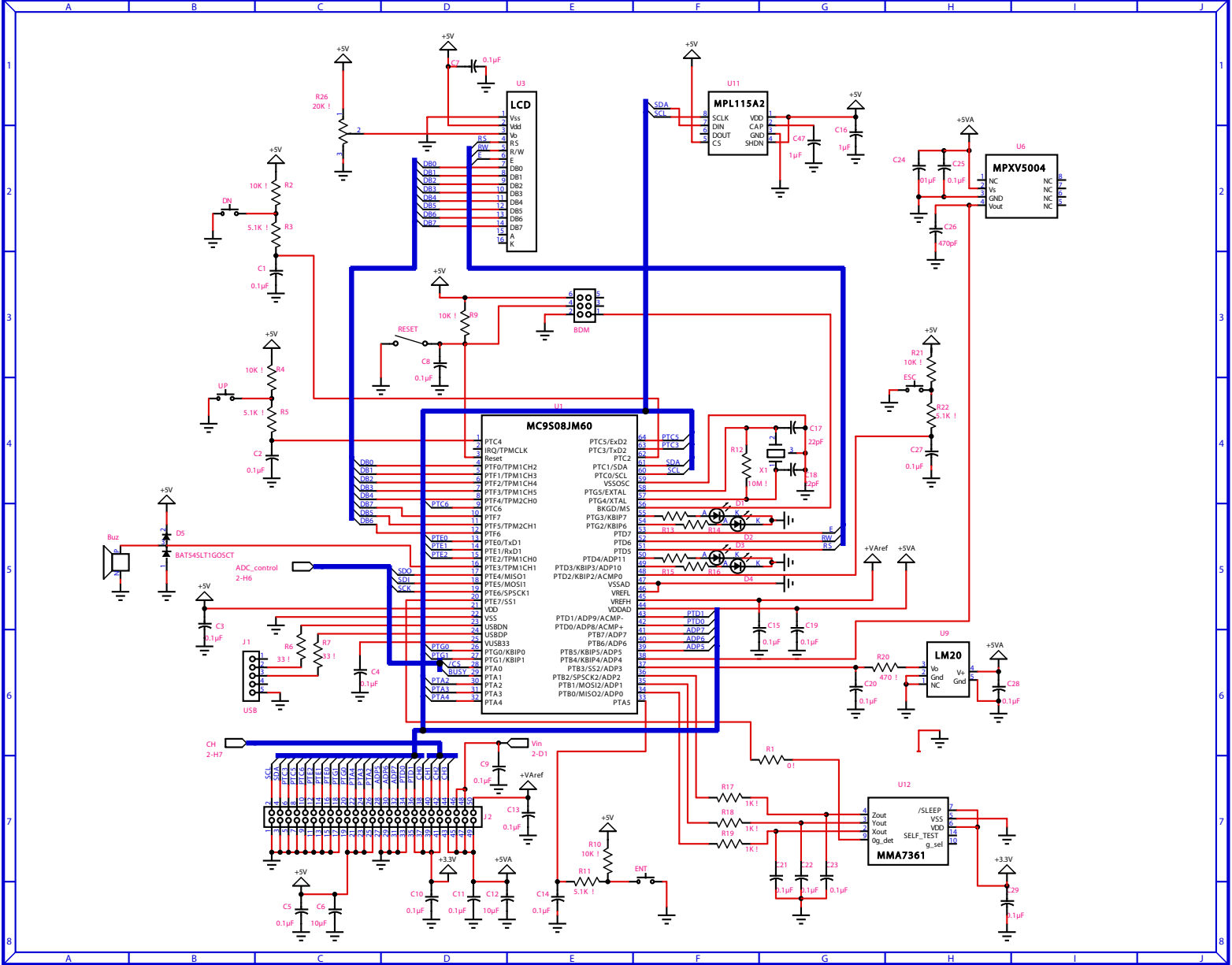

Figure 3.

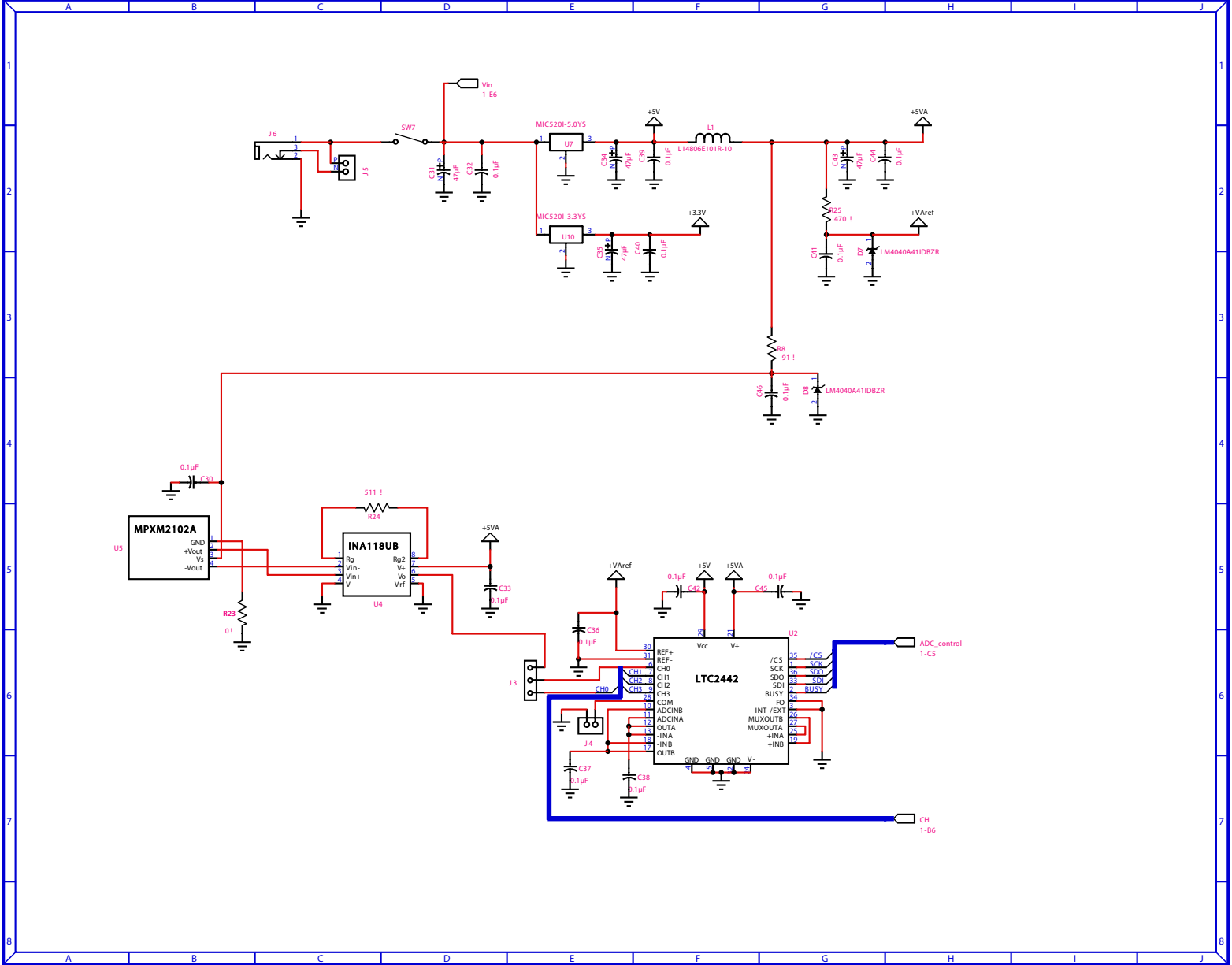

Figure 4.

Quick Start Guide

How to Read MPL115A Values on APEX Board

APEX Controls:

ON/OFF Switch: Located on the left side, under the LCD screen along the PCB edge. It is a slide switch.

Menu Selection Buttons: Located on the right side, next to the blinking LEDs.

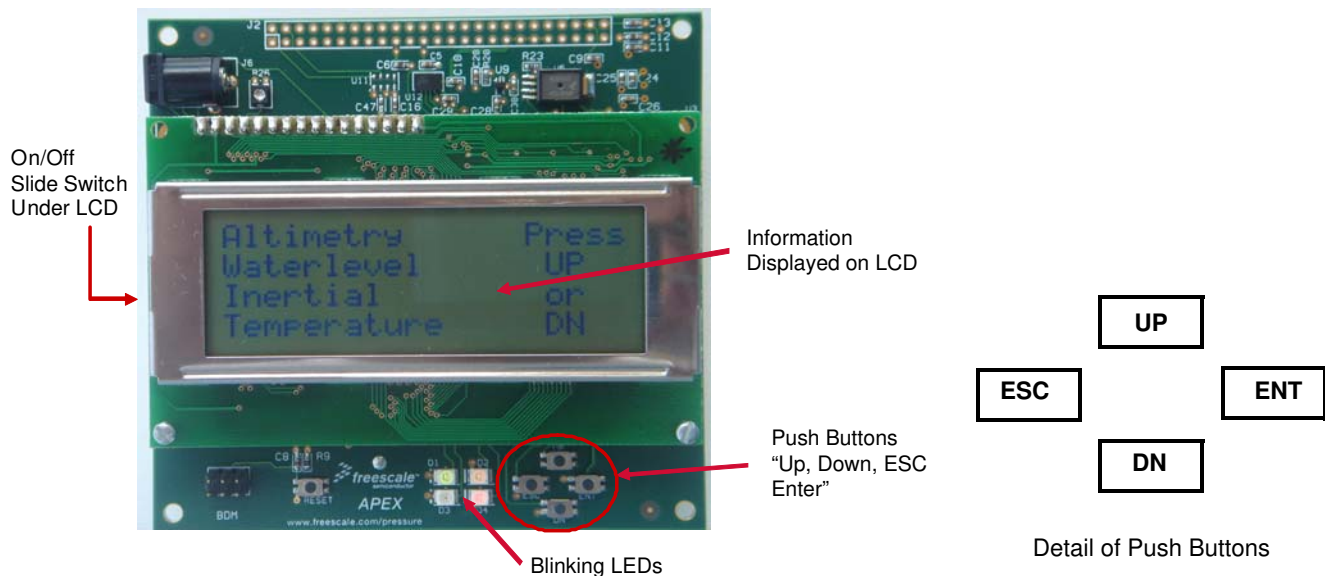
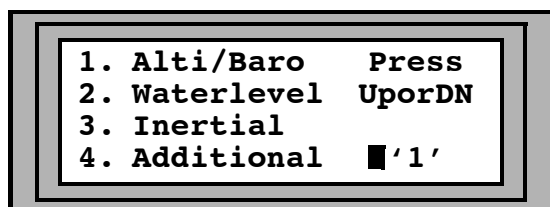

Figure 5. APEX Controls

MPL115A Pressure Shown on APEX Example

Navigating Through the Menu

Screen 1:



Press UP or DN until option "1. Altimetry" is selected
Press ENT

Screen 2:

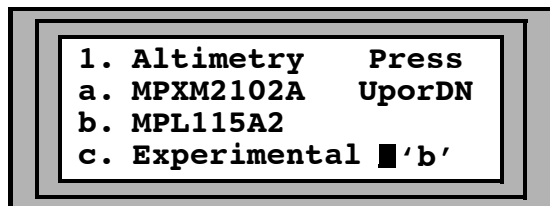

Press UP or DN until option "b. MPL115A2" is selected
Press ENT

Screen 3:

```
PPL115A2 Raw Values
Press ADC 5bc0 0367
Temp ADC 7a00 0488
ENTER for Coeff.
```

Pressure and Temperature Raw Values in decimal format are on the right in blue. Press ENT menu Button one time to move forward to see the coefficients.

Screen 4:

```
6 Coefficients:
3c ca      30  80
8a bd      84  33
b8 93      f2  c0
```

Coefficients are listed. Press ENT menu button to see compensated pressure reading.

Screen 5:

```
Compensated Pressure
PComp =
  97.273
```

Pressure is compensated and listed in kPa. Press ENT to continue to Alarm System. To navigate backwards, press ESC to cycle to previous screen.

Screen 6:

```
ALARM System
Enter your Threshold
      0.50 kPa
ENTER for Activation
```

Press UP or DN to set Pressure Threshold for the Alarm System in 0.25 kPa increments. Press ENT to activate the alarm feature and wait for the buzzer to sound.

Screen 7:

```
ALARM sounds when
Threshold is reached
Press.      97.273 kPa
ALARM      97.836
```

Alarm is armed and the current pressure is shown on top. The bottom is the threshold pressure for the alarm. Note the RED LED activates with the alarm and a green solid LED indicates a non alarm pressure. To navigate backwards: press ESC to cycle to previous screens and deactivate alarm.

Functions and the Screen Shot Navigation Path

Color Legend

- Inputs: User has to enter in a value, or select a choice, UP or DN. Typical inputs are shown in 'x' format. ESC repeatedly pressed, exits user to main menu.
- Outputs: Demo code returns a result or value based on the user inputs.

Simple Weather Station

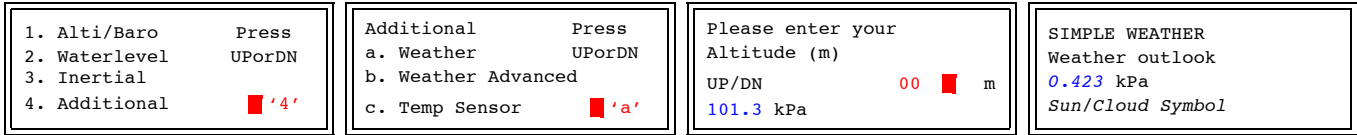

ENT ←

ENT ←

ENT ←

This is the altitude at your current location. Once its entered, the value of Pressure for that altitude is displayed.

The current Weather outlook is displayed in the options of Symbols: Sun, Rain, Sun/Cloud. Note the difference in pressure is displayed from current to Altitude.

Advanced Weather Station

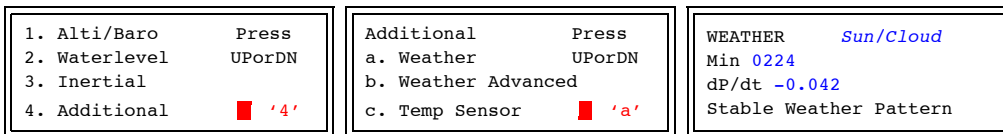

ENT ←

ENT ←

This shows the weather in the top right corner from the simple weather algorithm. The 'Min' shows how long the algorithm is working in minutes. dP/dt shows the differential change per an hour. The corresponding weather type is predicted in the bottom. This takes readings for up to 3 hours and compares results to the algorithm every 1/2 hour.

Waterlevel Sensing

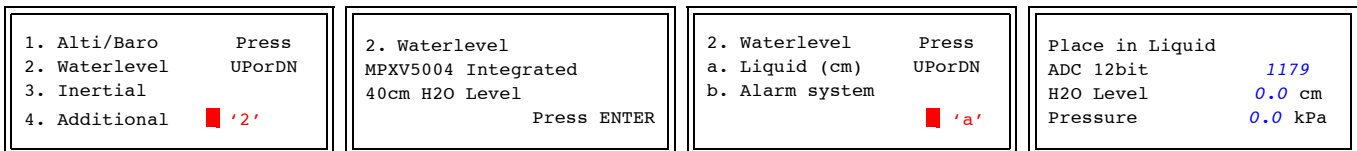

ENT ←

ENT ←

ENT ←

Selection of the Liquid Waterlevel section in 'a'.

Place tube attached to MPXV5004 into water. As it goes into the water, the value of water height will be displayed on the screen along with Pressure.

Waterlevel Alarm (sub-option from above menu)

```

2. Waterlevel      Press
a. Liquid (cm)    UPorDN
b. Alarm system   █ 'b'
    
```

```

Alarm System
Enter your Threshold
                    5.50 cm
ENTER for Activation
    
```

```

LARM sounds when
Threshold is reached
Press.              4.00 cm
ALARM               5.50 █
    
```

ENT ↵

ENT ↵

Press UP and DN to set the Alarm Threshold in increments of 0.25cm. Press ENT to activate the Alarm.

Alarm is now Active. Note the outputs of the current Pressure in cm, and the Alarm Threshold point. Once crossed, the red LED will flash as the buzzer sounds. Try activating by moving the tube up and down in a column of water.

Temperature Sensor

```

1. Alti/Baro      Press
2. Waterlevel    UPorDN
3. Inertial
4. Additional     █ '4'
    
```

```

Additional        Press
a. Weather       UPorDN
b. Weather Advanced
c. Temp Sensor   █ 'c'
    
```

```

Temperature
External Temp Sensor
1487 ADC
031 Deg C      087 Deg F
    
```

ENT ↵

ENT ↵

Value of the External Temperature sensor is displayed on the screen in °C and °F

Inertial Sensor

```

1. Alti/Baro      Press
2. Waterlevel    UPorDN
3. Inertial
4. Additional     █ '3'
    
```

```

3. Inertial
MMA7361L 3 Axis
Accelerometer 1.5g
Press ENTER
    
```

```

TRaw Values of Accel
X axis           1594
Y axis           1663
Z axis           2388
    
```

```

Tilt Angle
X axis           -2deg
Y axis           -4deg
Z axis           90deg
    
```

ENT ↵

ENT ↵

ENT ↵

ENT ↵

ADC values of the MMA7361L are displayed on the screen. Press Enter to proceed to the next screen

ADC values are converted and displayed on the screen as an angle for X, Y and Z axis. Press Enter to continue to Freefall Detection.

```

Freefall detect
Drop carefully in Linear
Freefall only.
FF detected!!
    
```

Drop board in linear manner to hear buzzer detecting Freefall condition, and Red LED will blink with buzzer. Exit Freefall and Inertial by pressing ESC.

Altimetry

```

1. Alti/Baro   Press
2. Waterlevel UPorDN
3. Inertial
4. Additional  ■ '1'
    
```

ENT ↵

```

1. Altimetry   Press
a. MPXM2102A  UPorDN
b. MPL115A2
c. Experimental ■ 'a'
    
```

ENT ↵

```

Raw Value      Altitude
0x017c1d       459m
2(LP) value    Pressure
0x017c1f       95.365 kPa
    
```

Select the MPXM2102A, option 'a' for higher resolution, amplified pressure readings for Altimetry.

Note the way that the output is displayed. The Raw value of the 24-bit ADC value is displayed on the left. The bottom left has the raw value after it passes two low pass filters in software. This value is mores stable but takes longer to update.

On the right the Altitude is displayed. This is the pressure converted to altitude in (m). The Pressure corresponding to the ADC value is shown in the bottom right.

The board can be placed on the table. Note the Altitude measurement as it stabilizes. Then raise it above your head as a '1m' increase. The value should go up by 1m. Place on the table again. It should drop to the original value. Place on the floor, it will again decrement 1m. Note that ambient pressure from A/C units can affect this value drastically.

Barometer Compensated Pressure Output

```

1. Altimetry   Press
a. MPXM2102A  UPorDN
b. MPL115A2
c. Experimental 'b'
    
```

ENT ↵

```

MPL115A2  Raw Values
Press ADC  74c0  0467
Temp ADC   6b40  0428
ENTER for Coefficients
    
```

ENT ↵

```

6 Coefficients
ao = 3dc4  c11 = f8a0
b1 = bd7a  c12 = 2flc
b2 = c299  c22 = 0dc0
    
```

ENT ↵

```

Compensated Pressure
PComp =9778 kPa
Altitude = 365 m
    
```

ENT ↵

The values for the MPL115A are shown here. To the left are the Pressure and Temp ADC values in their raw form in HEX. To the right of them are the shifted values displayed in decimal.

Values of the Coefficients are shown here. These are used for the next step in calculating the compensated Pressure.

Compensated Pressure is displayed. This is with an accuracy of ±1kPa.

Press ENT to continue to the Alarm section.

```

ALARM System
Enter your Threshold
                0.50 ■ kPa
Enter for Activation
    
```

ENT ↵

```

ALARM sounds when
Threshold is reached
Press.    96.574 kPa
ALARM    97.324 ■
    
```

Continued from the MPL115A compensated Barometer section above. Press UP and DN to set the Alarm Threshold in increments of 0.25kPa. Press ENT to activate the Alarm

Alarm is now Active. Note the outputs of the current Pressure in kPa, and the Alarm Threshold point. Once crossed, the red LED will flash as the buzzer sounds. Try activating by pressurizing the MPL115A. This can be done with a plastic syringe with rubber tubing at the end to make an air tight fit.

DEMOAPEXSENSOR Altitude Measurement

There are two sensors that can be used for altitude measurement. The MPL115A can be used as an approximate altimeter, but on this demo board, the MPXM2102A pressure sensor has been used to get a high resolution for altitude measurement. The MPXM2102A is an absolute pressure sensor. It measures the pressure on its port in relation to a vacuum sealed reference. The specs given on the data sheet do not easily translate into creating a product that resolves 1m of height difference. The DEMOAPEXSENSOR in this sense explores how a sensor can be amplified and put through a 24-bit delta sigma ADC to pursue that type of application.

There is more than one section in the software to determine the vertical altitude. The code has more than one method to try to improve the resolution the MPXM2102A. One method aims at a sub 1 foot increment, but this is not as stable as the 1m increment method. Again, this is a experimental board and the method used to measure the MPXM2102A for altitude is subject to many outside influences. These are not limited to, but include; sudden pressure changes, gusts of wind, A/C unit on/off cycling, temperature, and exposure to high brightness light. Note the value is setup for dynamic change. The altitude absolute height is not calibrated. This is typical of end application requiring a starting point.

Table 2. Operating Characteristics ($V_S = 10 V_{DC}$, $T_A = 25^\circ C$ unless otherwise noted, $P_1 > P_2$)

Characteristic	Symbol	Min	Typ	Max	Units	
Differential Pressure Range	P_{OP}	0	—	100	kPa	
Supply Voltage	V_S	—	10	16	V_{DC}	
Supply Current	I_O	—	6.0	—	mAdc	
Full Scale Span	V_{FSS}	38.5	40	41.5	mV	
Offset	V_{OFF}	MPX2102D Series	—	1.0	mV	
		MPX2102A Series	-2.0	—	2.0	
	V_{OFF}	MPXM2102D/G Series	-1.0	—	1.0	mV
		MPXM2102A Series	-2.0	—	2.0	
Sensitivity	$\Delta V/\Delta P$	—	0.4	—	mV/kPa	
Linearity	—	MPX2102D Series	—	0.4	% V_{FSS}	
		MPX2102A Series	-1.0	—	1.0	
	—	MPXM2102D/G Series	-0.6	—	0.4	% V_{FSS}
		MPXM2102A Series	-1.0	—	1.0	
Pressure Hysteresis (0 to 100 kPa)	—	—	± 0.1	—	% V_{FSS}	
Temperature Hysteresis (-40°C to +125°C)	—	—	± 0.5	—	% V_{FSS}	
Temperature Coefficient of Full Scale Span	TCV_{FSS}	-2.0	—	2.0	% V_{FSS}	
Temperature Coefficient of Offset	TCV_{OFF}	-1.0	—	1.0	mV	
Input Impedance	Z_{IN}	1000	—	2500	W	
Output Impedance	Z_{OUT}	1400	—	3000	W	
Response Time (10% to 90%)	t_R	—	1.0	—	ms	
Warm-Up Time	—	—	20	—	ms	
Offset Stability	—	—	± 0.5	—	% V_{FSS}	

Table 2 shows the typical operating characteristics of the MPXM2102A. The supply voltage is ratiometric, but at 10V supply, the FSS is 40 mV for 100 kPa of applied absolute pressure. The DEMOAPEXSENSOR does not have a full 10V supply. The part is biased instead by a 5V supply. This cuts the FSS to 20 mV for 100 kPa. Since the output of an analog sensor is ratiometric to the input voltage, it is crucial to have a stable supply voltage. In the case of amplifying and analyzing small pressure changes, the input voltage must be stable to remove input noise. To achieve this, a shunt voltage reference connected to the 5V regulator provides a low noise, stable voltage of 4.096V for the MPX2102A. This is the IC, D8 on the demo schematic, and is typically used for data-acquisition systems. Thus, the span is really only 16.38 mV at 4.096V, for a pressure range of 0 to 100 kPa. MPXM2102A is on a separate shunt such that no other connected IC will induce additional noise on the shared line.

Hardware Issues to Consider when Designing such a Circuit

ADC Resolution: Since the MPXM2102A is an analog part, the ADC resolution is important to get the resolution needed for stable measurement. The ADC has to be greater than 16-bits to gain 3 foot intervals in measurement.

Noise: Noise on the board has to be minimized. The digital and analog supplies and grounds must be separated. The MPXM2102A on the DEMOAPEXSENSOR has its own dedicated shunt voltage reference after the 5V regulator. The external ADC also has its own digital and analog 5V lines separated. The reference voltage on the ADC has its own shunt reference to provide a stable value to compare ADC results. The board is 4 layers with a ground and Vdd plane to minimize parasitic capacitance that creates noise. Analog 5V has its own separated section from the digital 5V in the power layer of the layout. This minimizes the noise on both 5V digital and 5V analog sections.

Air Flow: The pressure sensor should have a cover when trying to measure a sub 1 m altitude measurement. Either the unit should be housed in a box, or in a customer application and should have a method to introduce a laminar flow of air. This will reduce A/C and breeze effects on the pressure sensor. Most applications of such, include a housing perforated with small holes. This prevents a strong breeze from affecting the sensor, by filtering out the drastic pressure changes. DEMOAPEXSENSOR, as a demo board, has no such housing.

Software Considerations

Filtering: There are high frequency noise and sensor fluctuations that have to be handled. In the software, two low pass filters are used to minimize fluctuations in the ADC values. This makes the conversions slower, but the values are more stable. Low pass filters are better than using a running average. A running average is a filter that does not discriminate noise outliers as well, since it is included in the result.

Calibration Routines: As seen in the experimental section of the APEX board, it is possible to improve results with various software calibrations. A simple example is done in the APEX code, but could be further worked with a possibility of multiple sensors to take this further with motion combined. It will be explained in the short distance model of altimetry in this application note.

Altimetry Background Information (refer to AN3914)

Altimetry utilizes absolute pressure sensors. An absolute sensor measures the deflection of the surrounding barometric pressure with reference to a known pressure (usually a vacuum). This allows it to compare the air pressure at sea level (101.3kPa) to the vacuum to gain an absolute pressure result. At a different elevation, the barometric (surrounding) pressure can be compared again to the vacuum for that absolute pressure result. Since both readings were taken against the same reference, they can be compared against each other.

Barometric pressure does not have a linear relationship with altitude. As altitude increases, the pressure decreases. Common reference points are given in [Table 3](#).

Table 3. Reference Points

Location	Altitude (m)	Altitude (ft)	Pressure (kPa)
Sea Level	0	0	101.3
Dead Sea (lowest surface on earth)	-396	-1300	106
Summit of Everest	10,058	+33,000	33

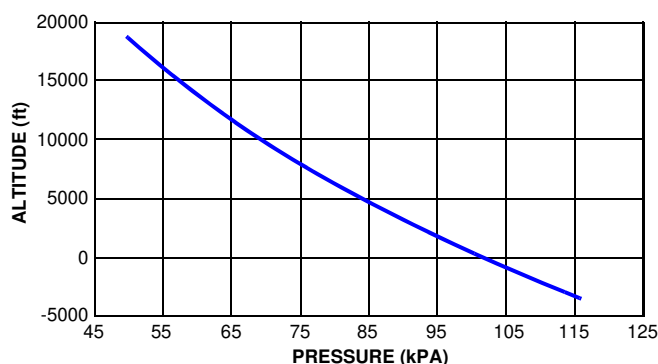

Figure 6. Altitude vs. Pressure

At low elevations, a square meter on the earth's surface has greater weight above it than at higher altitudes. This is due to the mass of water vapor and air that sits upon it. Imagine cubes of air and water vapor stacked from the ground to space. At the low altitude there is more cubic mass above, while higher altitudes will have less of these stacked above it.

Air and water vapor will compress more at sea level and the air is significantly denser than at high altitude. The density is not uniform with altitude, and thus the pressure is not either. The reason for altitude's non-linear relationship is that air has infinite compressibility. It disproportionately compresses more as weight is placed upon it. Hence the graph of Pressure vs. Altitude seen in [Figure 6](#).

The simplified mathematical equation used to calculate altimetry in [Table 3](#) is:

$$p_h = p_0 \cdot e^{\frac{-h}{7990m}} \quad (\text{eq. 1})$$

$$h = 18400m \cdot \log \frac{p_0}{p_h} \quad (\text{eq. 2})$$

Assuming $p_0 = 101.3 \text{ kPa}$

p_h - Pressure at height h

p_0 - Initial Pressure point at sea level or 101.3 kPa

Calculations for a 24-bit ADC

First: Figuring out how the 24-bit ADC translates to counts, followed by pressure and altitude.

Table 4.

ADC Resolution	Range of ADC Counts
8-bit	0 to 255
12-bit	0 to 4095
16-bit	0 to 65,535
18-bit	0 to 262,143
24-bit	0 to 16,777,215

24-bit ADC LTC2442 reference voltage is 4.1V (temperature and voltage stable shunt).

MPXM2102A has a 16.4 mV span @ 4.1V supply.

Output is gained x 98.8 by instrumentation amplifier.

Span of differential amplified signal is now 1.62V.

Low pressure end of 0 kPa input is approximately 0V seen at the differential amplifier output.

Conversely the higher end of the pressure reading at 100 kPa is = 1.62V.

SPAN of MPXM2102A after Differential Instrumentation Amplifier is now 1.62V.

The 24-bit ADC would have a resolution of $4.1V/16777215$ counts or $0.244 \mu V$ per an ADC count. Since the differential span of the sensor is 1.62V after the amplifier, the span of 0 to 100 kPa can be seen as a ADC value of 0 counts to 6629045 counts. This makes each ADC count equivalent to 0.0000151 kPa or 0.0151 Pa . The LTC2442's value was shortened to a 18-bit conversion to minimize the baseline noise seen on the ADC output.

For an 18-bit ADC conversion, $4.1V/262143$ equals a resolution of $15.6 \mu V$ per a single ADC count. Since the differential span of the sensor is 1.62V after the amplifier, the span of 0 to 100 kPa can be seen as a ADC value of 0 counts to 103846 counts. This makes each ADC count for the pressure span equivalent to 0.000963 kPa or 0.963 Pa .

Summarizing in [Table 5](#)

Table 5.

ADC Type	Resolution ($\mu\text{V}/\text{ADC}$)	Resolution (kPa/ADC)
24-bit	0.244 μV	0.0000151 kPa
18-bit	15.6 μV per 1 ADC count	0.000963 kPa per 1 ADC count

DEMOAPEXSENSOR can read a 0.000963 (kPa/ADC count) step for a 0 to 100kPa MPXM2102A sensor.

The formulas earlier were shown to reference the pressure to altitude relationship.

Converting all this to altitude:

Table 6.

Distance	Pressure (mB)	Pressure (kPa)	Voltage Change (μV)	ADC (counts)
0.5 m	0.05	0.005	0.81	5.19 so ~5
1 m	0.11	0.011	1.78	11.4 so ~11
3 ft	0.09	0.009	1.46	9.35 so ~9
1 ft	0.03	0.003	0.49	3.11 so ~3

Reviewing [Table 6](#), the DEMOAPEXSENSOR has code written to interpret small pressure changes and convert these to altitude. The conversion from pressure to altitude still has to use the exponential equation for a proper conversion. But the approximate distances and the ADC count equivalent are shown here. These are approximate across the pressure range but as written in the demo code, the pressure is determined first, the altitude second. The altitude is calculated via the pressure value inserted into the exponential altitude-pressure formula.

Experimental Altimetry Section

The preceding section on Altimetry has used the pressure sensor value to convert the pressure to an altitude reading. This value of pressure is not linear with vertical height as detailed in the graph of [Figure 6](#). However if a curved line is magnified enough, the end result can be treated as a straight line. The “Experimental” section of the Altimeter/Barometer tries this particular method. Due to changing air currents and unstable smaller resolution, it may require outdoor demonstration to get better results.

In this example the chart outlines the calibration routine.

- To calibrate the part, first place the board on the floor or table in front of you.
- Wait until the low pass filtered value is stable then press Enter. This saves the “0 level” barometric pressure.
- Following this, place the board about 3 feet above the “0 level”. Either this is at waist height if previously on the floor, or above your head if previously on the table. When the value stabilizes, press Enter again.

Now the display will output the distance in smaller increments than 1 foot. Notice how it tends to jump around, and the “0 level” shifts. This Experimental section shows how this method while being more accurate is not as stable as the exponential method to see pressure. The resolution is reasonable for a short period of time before barometric changes in pressure change the calibration.

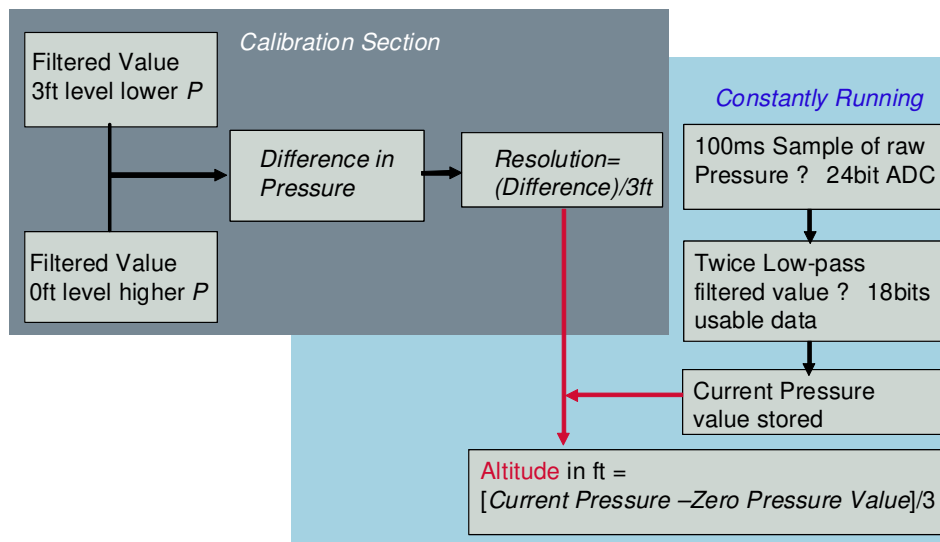

Figure 7. APEX Short Distance Calibration Routine

DISSECTION OF THE ISSUES FACING THE PRESSURE READING

Note that with trying to resolve flowchart in Figure 7, there are issues as mentioned with the physical surroundings. A/C on/off cycling along with airflow in the form of a breeze. Doors opening and closing change the pressure dynamic of a room as the air flows in or out. This leads to the shifting in the zero level of the altitude as demonstrated in the flowchart.

This causes the scenario of leaving the APEX on the table and seeing that the 0 foot reading shifts up and down – due to the many root causes in barometric pressure change. This is shown as an ‘experiment’ in the demo board. A straight linear pressure-altitude can sometimes work, but generally the shifting pressure wrecks havoc on the result.

Multiple sensor systems can be used to possibly stabilize the result. For example, a multiple sensor system can use the accelerometer to detect movement and re-zero altimeter readings, if pressure changes are not related to movement.

High Resolution Altimetry Customer Implementations

Altimetry

Raw Value	Altitude
0x017c1d	459m
2(LP) value	Pressure
0x017c1f	95.365 kPa

In the Altimetry screen shot as seen in the [Quick Start Guide](#), note the raw and the twice Low-Pass filtered values. These are converted using the pressure equations 1 and 2 as seen on [page 12](#) for pressure and altitude conversion. The APEX does not have a calibration for the altitude as most customer implementations of high resolution pressure, zero a point and measure the dynamic change in meters for a given amount of time. The following are examples of ways to implement a high resolution altimeter with focus on the ‘dynamic’ changing pressure rather than a constant absolute altitude reading.

Altimeter Example 1:

A person sets a zero point before hiking a steep hill. At the top of the hill, the change in barometric pressure is related to meters or feet. This is a measure of the dynamic change of pressure over a short distance. This is a targeted application versus the other application of knowing the altitude from sea level at all times after one factory calibration.

Altimeter Example 2:

A GPS equipped smart-phone loses GPS signal as it enters a building. Knowing the approximate elevation with the GPS, the beginning 'zero point' is 300 m. Entering the building the pressure sensor starts measuring the elevation, and tries to calculate the height in meters.

Issues in this Example for Consideration:

- When entering a building from outside, a sudden rise in pressure is highly probable. This will send two different scenarios. It could signify that the user has 'fallen' in altitude by several meters (such as jumping off a building or small cliff). Or they have entered into a building with significant pressurized airflow (typical of an air-conditioned lobby with high air flow).
- Buildings vary on height per a floor. Lobbies of sky-rises have higher ceilings. Hotel accommodation floors tend to have shorter standard heights. A restaurant located halfway or on top of the building may have a higher ceiling. The main point is that the altitude in meters does not ideally correspond to floor location.
- Large buildings can be pressurized or not. It depends on building design. Some stadiums for sporting events are pressurized to keep a fabric roof afloat. Tall high-rises have multiple stages of air-conditioning units. This leads to varied pressure per a floor depending on that section's on/off cycle, fan speed, or the air-tight nature of that section. Elevator shafts also can equalize pressure, or create some pressure change as elevators move up and down.
- Smart use of Altimetry in tall buildings would use building information stored in a 'smart' GPS device so the altitude can translate to floor level. This way location based services, emergency 911, etc. can know which floor the user is located.

MPL115A Miniature Barometer DEMOAPEXSENSOR

The MPL115A is a small 5 x 3 x 1.2 mm digital absolute pressure sensor. It is available in either I²C or SPI version. It has a pressure range of 50 to 115 kPa. This narrower range is more application specific for events occurring in that altitude or in devices requiring that pressure. In this section, the DEMOAPEXSENSOR's implementation of the MPL115A and the information displayed on the APEX is described.

In the [Quick Start Guide](#) section, the "Barometer Compensated Pressure Output" describes the compensated Pressure output of the MPL115A in screen shots of the DEMOAPEXSENSOR.

Barometer Compensated Pressure Output

Stage 1	Stage 2	Stage 3
<pre>MPL115A2 Raw Values Press ADC 74c0 0467 Temp ADC 6b40 0428 ENTER for Coefficients</pre>	<pre>6 Coefficients ao = 3dc4 c11 = f8a0 b1 = bd7a c12 = 2f1c b2 = c299 c22 = 0dc0</pre>	<pre>Compensated Pressure PComp =9778 kPa Altitude = 365 m</pre>
Raw Values of Temperature and Pressure displayed on LCD screen.	Display of 6 coefficients listed on LCD screen.	Display of Compensated Pressure output in kPa units.

The MPL115A's Implementation is described in detail in the Application Note AN3785; How to Implement the Freescale MPL115A Digital Barometer. Essentially in the LCD screen shots above, the Raw values of Pressure and Temperature are displayed in Hexadecimal and Decimal format. Following this, the six coefficients MSB+LSB are shown in Hex format. The combination of this data (streamed via I²C or SPI from the MPL115A) is used at the host MCU to calculate the Pcomp value. Using eq. 2, the altitude is calculated and shown in meters.

The Pcomp value is the compensated absolute pressure value. This value unlike the analog pressure sensors does not require any calibration trim, or offset auto zero. The Pcomp spec for the MPL115A is such that the value has an accuracy of ± 1kPa. The advantage is implementing the sensor and having the compensated pressure readings without any additional calibration etc. on the customer side.

As stated in AN3785, the MCU has to apply the equation below for Pcomp given that a0, b1, b2, c11, c12, c22 are coefficients stored in MPL115A registers. Padc and Tadc are the raw ADC values of Pressure and Temperature that are clocked out of MPL115A digitally.

$$P_{comp} = a_0 + (b_1 + c_1 \cdot P_{adc} + c_{12} \cdot T_{adc}) \cdot P_{adc} + (b_2 + c_{12} \cdot T_{adc}) \cdot T_{adc}$$

(eq. 3)

This is applied in the MCU code as a series of operations so the MCU does not have to apply the equation directly. The following is a possible sequence for the calculation Pcomp, the trimmed pressure output. Input values are in **bold**.

```

c11x1 = c11 * Padc
a11 = b1 + c11x1
c12x2 = c12 * Tadc
a1 = a11 + c12x2
c22x2 = c22 * Tadc
a2 = b2 + c22x2
a1x1 = a1 * Padc
y1 = a0 + a1x1
a2x2 = a2 * Tadc
Pcomp = y1 + a2x2

```

Note that the Altitude measurement displayed for the MPL115A cannot be directly compared to the previous section on the MPXM2102A. The MPL115A has an internal 10-bit ADC, with an accuracy of ± 1 kPa. The system set up on the DEMOAPEXSENSOR for the MPXM2102A shows less than 1m resolution with a 24-bit ADC. The additional hardware cost, digital and analog noise filtering, and calibration required is substantial compared to implementing the MPL115A directly to an MCU. The value of the altitude changes constantly on the display, but it is also a raw conversion. It could be filtered, sampled in longer intervals etc. to give the illusion of a more stable value. Here it is shown simply to get an idea of the raw conversion result. The MPL115A can be used to measure changes in vacuum or for barometric pressure rather than the MPXM2102A.

In the [Quick Start Guide](#) there is a section to set a threshold above the current barometric pressure for an alarm. When the alarm is set, the status LEDs will light up green. After the alarm threshold is reached, the red LED toggles on/off while a buzzer is sounded. This can be activated via waiting for a pressure change, or applying pressure to the DEMOAPEXSENSOR. A clear Ziploc bag or syringe with a soft applicator tip useful in activating the alarm.

Weather Station Implementation

Freescale application note, AN3914, details altimetry and barometric weather systems and also includes code examples from the DEMOAPEXSENSOR. There are two sections in the APEX board; a simple weather station or an advanced method. The simple method does a comparison by asking the user to input their known altitude, and comparing this pressure to that of the MPL115A. The delta in the value is compared in the [Table 7](#).

Table 7.

Analysis	Output
dP > +0.25 kPa	Sun Symbol
-0.25 kPa < dP < 0.25 kPa	Sun/Cloud Symbol
dP < -0.25 kPa	Rain Symbol

This is typical of a simple application and the APEX simulates a desktop barometer that is commonly bought at retailers.

A more advanced version of this calculates the pressure change by taking values over time and seeing the delta change over a 3 hour period. This is outlined in [Table 8](#) (AN3914).

Table 8. Advanced Weather Determination

Analysis	Output
dP/dt > 0.25 kPa/h	Quickly rising High Pressure System, not stable
0.05 kPa/h < dP/dt < 0.25 kPa/h	Slowly rising High Pressure System, stable good weather
-0.05 kPa/h < dP/dt < 0.05 kPa/h	Stable weather condition
-0.25 kPa/h < dP/dt < -0.05 kPa/h	Slowly falling Low Pressure System, stable rainy weather
dP/dt < -0.25 kPa/h	Quickly falling Low Pressure, Thunderstorm, not stable

Waterlevel Implementation with the MPXV5004G

The DEMOAPEXSENSOR has the MPXV5004G gauge pressure sensor on board. This is located on the backside of the demo board. It has a top port, which is to be used with the supplied high temp silicone hose.

The output of the MPXV5004G is shown in [Table 9](#).

Table 9. Operating Characteristics ($V_S = 5.0 V_{DC}$, $T_A = 25^\circ C$ unless otherwise noted, $P1 > P2$)

Characteristic	Symbol	Min	Typ	Max	Units	
Pressure Range	P_{OP}	0	—	3.92 400	kPa mm H ₂ O	
Supply Voltage	V_S	4.75	5.0	5.25	V_{DC}	
Supply Current	I_S	—	—	10	mAdc	
Span @ 306 mm H ₂ O (3 kPa)	V_{FSS}	—	3.0	—	V	
Full Scale Span @ 400 mm H ₂ O (3.92 kPa)		—	4.0	—		
Offset	V_{OFF}	0.75	1.0	1.25	V	
Sensitivity	V/P	—	1.0	—	V/kPa	
Accuracy	0 to 100 mm H ₂ O (10 to 60°C)	—	—	—	±1.5	% V_{FSS} with auto zero
	100 to 400 mm H ₂ O (10 to 60°C)	—	—	—	±2.5	% V_{FSS} with auto zero
	0 to 400 mm H ₂ O (10 to 60°C)	—	—	—	±6.25	% V_{FSS} without auto zero

The part has a offset of 1V with a sensitivity of 9.8 mV/mm H₂O. On the DEMOAPEXSENSOR the value is sampled with a 12-bit ADC from the JM60 MCU. Note the following when considering waterlevel:

- It is important to implement Auto Zero (AN1636) to improve accuracy.
- Calibration can be done, ideally with a two point calibration.
- The sensor must be implemented with an air column buffer between the liquid and the sensor. This is done with a section of tubing as in [Figure 8](#).
- It is a gauge application, so the pressure measured is with respect to barometric pressure; when elevation varies, the pressure seen at the sensor is the same, only dependent on liquid height.

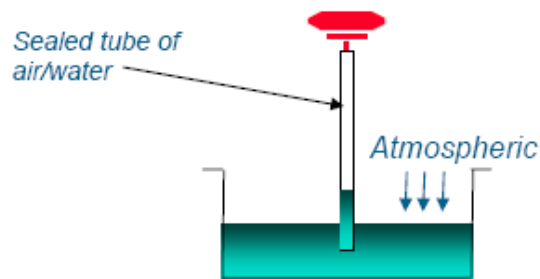

Figure 8. Waterlevel Connection to Pressure Sensor

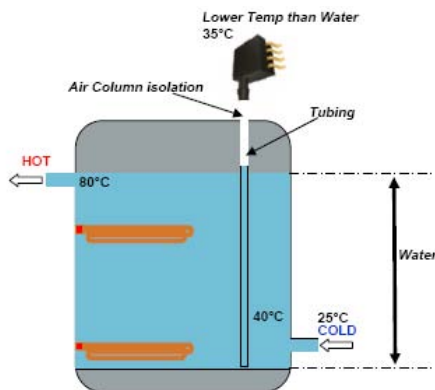

Figure 9. Hot Water Heater

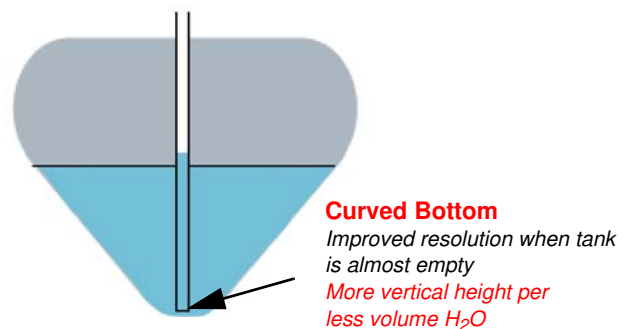

Figure 10. Conical Bottom for Measurement

Figure 9 and Figure 10 are examples of water measurement. In the hot water heater to the left, although the temperature of the water can be high, a long enough tube combined with air column separation provides a buffer for measurement. Water and Air are good insulators, so temperature variation can be quite drastic in a short distance. This is a design advantage in isolating the sensor from heat.

In Figure 10 the diagram has a method to improve resolution of the water level. The vertical height measurement is kept constant, but the volume of water dispensed or left in the bottom is improved. This is done by simply making a conical bottom. The resolution in vertical height can be used to improve the volume measurement. Additional ADC counts per a volume of water are achieved, than a shape with a broad based bottom.

AUTO ZERO

A summary of the application note AN1636 is that the offset of the pressure sensor can change during board mount, stress, or temperature shifts. By sampling the offset pressure (voltage output with no pressure input) and storing this value in the MCU, the changes in the offset are negated. This improves the overall accuracy of the voltage output of the sensor, since the offset changes are negated. Normally this would occur in a final product when there is a startup or a cycle when the sensor is not pressurized.

CALIBRATION

The best calibration would be a two part calibration. A Pressure would be taken at 0 mm of H₂O and also when the tubing is at 40 cm of H₂O. The difference in ADC counts divided by 40 cm will give the number of ADC counts per a cm etc. for each sensor. This is the best calibration, but is not implemented on the DEMOAPEXSENSOR in software rev 1.0.

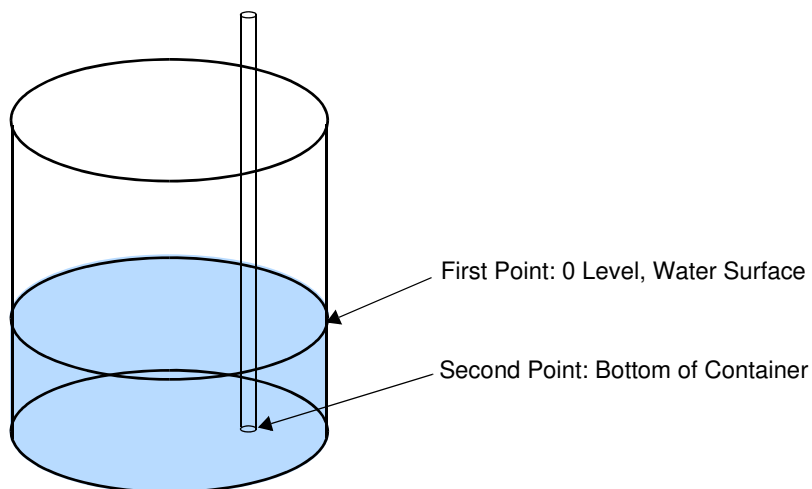

Figure 11. Two Part Calibration

Inertial MMA7361L

The DEMOAPEXSENSOR has a quick implementation of the 3 axis selectable low-g accelerometer. Notably the demo board implements the tilt function of the accelerometer and Freefall detection. The [Quick Start Guide](#) shows the modes to select either function.

TILT ANGLE ON THE DEMOAPEXSENSOR

The ADC counts are converted to tilt angles using the equation below:

$$V_{out} = V_{off} + \left(\frac{\Delta V}{\Delta g} \cdot 1.0g \cdot \sin\theta \right)$$

(eq. 4)

Where: V_{out} = Analog output of accelerometer
 V_{off} = Offset voltage of accelerometer
 V/g = Sensitivity
 $1.0g$ = Earth's gravity
 θ = Tilt Angle

Note: MMA7361 was set to a g-level of 1.5 g.
Offset voltage is typically 1.65V @ 3.3V biasing supply

FREEFALL DETECT ON THE DEMOAPEXSENSOR

Freefall detect is the situation where all three axes of the inertial sensor converge towards the offset or '0g' range. This is also given as an output on the MMA7361L as the 0g-Detect pin. '1' or logic high is the output for a detected Freefall. Note that this is also for Freefall in a linear fashion such that the board is not spinning or in rotation as it falls. The DEMOAPEXSENSOR emits a buzzer noise and a flashing red LED as the Freefall detect occurs.

How to Reach Us:

Home Page:

www.freescale.com

Web Support:

<http://www.freescale.com/support>

USA/Europe or Locations Not Listed:

Freescale Semiconductor, Inc.
Technical Information Center, EL516
2100 East Elliot Road
Tempe, Arizona 85284
1-800-521-6274 or +1-480-768-2130
www.freescale.com/support

Europe, Middle East, and Africa:

Freescale Halbleiter Deutschland GmbH
Technical Information Center
Schatzbogen 7
81829 Muenchen, Germany
+44 1296 380 456 (English)
+46 8 52200080 (English)
+49 89 92103 559 (German)
+33 1 69 35 48 48 (French)
www.freescale.com/support

Japan:

Freescale Semiconductor Japan Ltd.
Headquarters
ARCO Tower 15F
1-8-1, Shimo-Meguro, Meguro-ku,
Tokyo 153-0064
Japan
0120 191014 or +81 3 5437 9125
support.japan@freescale.com

Asia/Pacific:

Freescale Semiconductor China Ltd.
Exchange Building 23F
No. 118 Jianguo Road
Chaoyang District
Beijing 100022
China
+86 010 5879 8000
support.asia@freescale.com

For Literature Requests Only:

Freescale Semiconductor Literature Distribution Center
1-800-441-2447 or +1-303-675-2140
Fax: +1-303-675-2150
LDCForFreescaleSemiconductor@hibbertgroup.com

Information in this document is provided solely to enable system and software implementers to use Freescale Semiconductor products. There are no express or implied copyright licenses granted hereunder to design or fabricate any integrated circuits or integrated circuits based on the information in this document.

Freescale Semiconductor reserves the right to make changes without further notice to any products herein. Freescale Semiconductor makes no warranty, representation or guarantee regarding the suitability of its products for any particular purpose, nor does Freescale Semiconductor assume any liability arising out of the application or use of any product or circuit, and specifically disclaims any and all liability, including without limitation consequential or incidental damages. "Typical" parameters that may be provided in Freescale Semiconductor data sheets and/or specifications can and do vary in different applications and actual performance may vary over time. All operating parameters, including "Typicals", must be validated for each customer application by customer's technical experts. Freescale Semiconductor does not convey any license under its patent rights nor the rights of others. Freescale Semiconductor products are not designed, intended, or authorized for use as components in systems intended for surgical implant into the body, or other applications intended to support or sustain life, or for any other application in which the failure of the Freescale Semiconductor product could create a situation where personal injury or death may occur. Should Buyer purchase or use Freescale Semiconductor products for any such unintended or unauthorized application, Buyer shall indemnify and hold Freescale Semiconductor and its officers, employees, subsidiaries, affiliates, and distributors harmless against all claims, costs, damages, and expenses, and reasonable attorney fees arising out of, directly or indirectly, any claim of personal injury or death associated with such unintended or unauthorized use, even if such claim alleges that Freescale Semiconductor was negligent regarding the design or manufacture of the part.

Freescale and the Freescale logo are trademarks of Freescale Semiconductor, Inc., Reg. U.S. Pat. & Tm. Off.

All other product or service names are the property of their respective owners.

© Freescale Semiconductor, Inc. 2010. All rights reserved.