



Chipsmall Limited consists of a professional team with an average of over 10 year of expertise in the distribution of electronic components. Based in Hongkong, we have already established firm and mutual-benefit business relationships with customers from,Europe,America and south Asia,supplying obsolete and hard-to-find components to meet their specific needs.

With the principle of “Quality Parts,Customers Priority,Honest Operation,and Considerate Service”,our business mainly focus on the distribution of electronic components. Line cards we deal with include Microchip,ALPS,ROHM,Xilinx,Pulse,ON,Everlight and Freescale. Main products comprise IC,Modules,Potentiometer,IC Socket,Relay,Connector.Our parts cover such applications as commercial,industrial, and automotives areas.

We are looking forward to setting up business relationship with you and hope to provide you with the best service and solution. Let us make a better world for our industry!



Contact us

Tel: +86-755-8981 8866 Fax: +86-755-8427 6832

Email & Skype: info@chipsmall.com Web: www.chipsmall.com

Address: A1208, Overseas Decoration Building, #122 Zhenhua RD., Futian, Shenzhen, China





YETDA INDUSTRY LTD.

Technical Data Sheet

MODEL NO : Q150OVS4

1206Package 3.2*1.6mm Chip LEDs

Features :

- Package in 8mm tape on 7" diameter reel
- Compatible with automatic placement equipment
- Compatible with reflow solder process

Applications :

- Indicators
- Automotive : backlighting in dashboard and switch
- Backlight for LCD

Di ce materi al	Emitted color	Lens Color
Al GaInP	Red	Water Clear

Electrical /Optical Characteristics(Ta=25°C)

Parameter	Symbol	Condition	Min	Typ.	Max	Unit
Luminous Intensity	Iv	IF=20mA	80	150		mA
Dominant Wavelength	λ_D	IF=20mA		625		nm
Peak Emission Wavelength	λ_p	IF=20mA		632		nm
Viewing Angle	2 θ 1/2	IF=20mA		130		Deg
Forward Voltage	Vf	IF=20mA		2.0	2.4	V
Reverse Current	IR	VR=5V			10	μ A

Absolute Maximum Ratings(Ta=25°C)

Parameter	Symbol	Maximum	Unit
Power Dissipation	Pd	78	mW
Peak Forward Current (1/10 Duty Cycle 0.1ms Pulse Width)	IF (Peak)	100	mA
Continuous Forward Current	IF	30	mA
Reverse Voltage	VR	5	V
Derating Linear From 25°C		0.3	mW/°C
Operating Temperature Range	Topr	-30 to +80	°C
Storage Temperature Range	Tstg	-40 to +90	°C

20090727



YETDA INDUSTRY LTD.

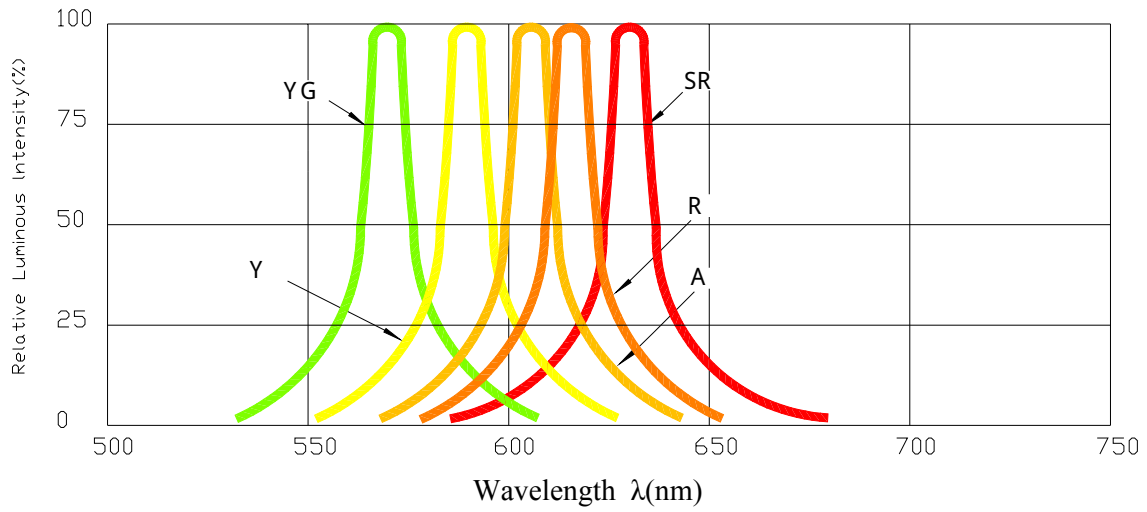

Forward Current Vs. Forward Voltage
 $T_a=25^\circ\text{C}$

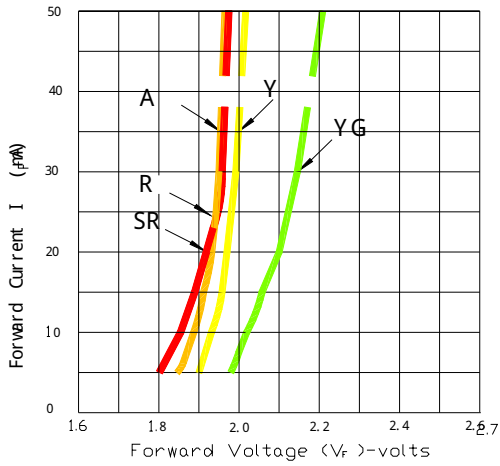

Forward Current Derating Curve

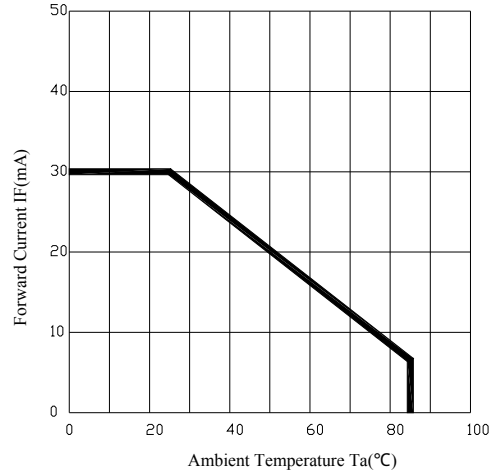

Luminous Intensity Vs. Forward Current
 $T_a=25^\circ\text{C}$

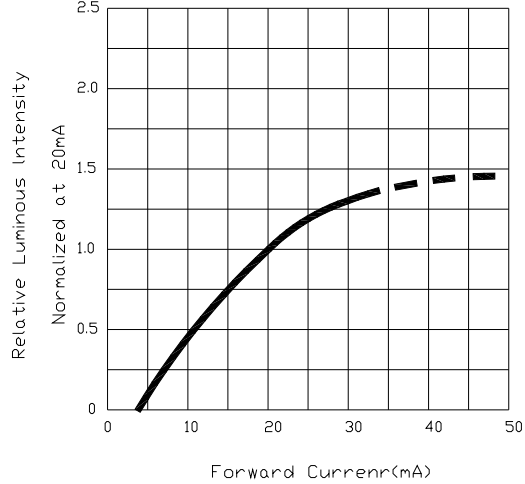

Radiation Diagram
 $T_a=25^\circ\text{C}$

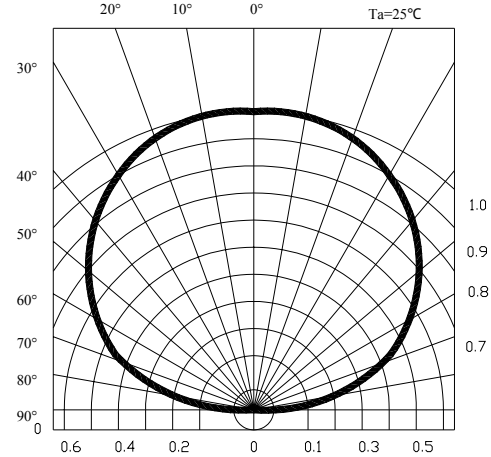



YETDA INDUSTRY LTD.

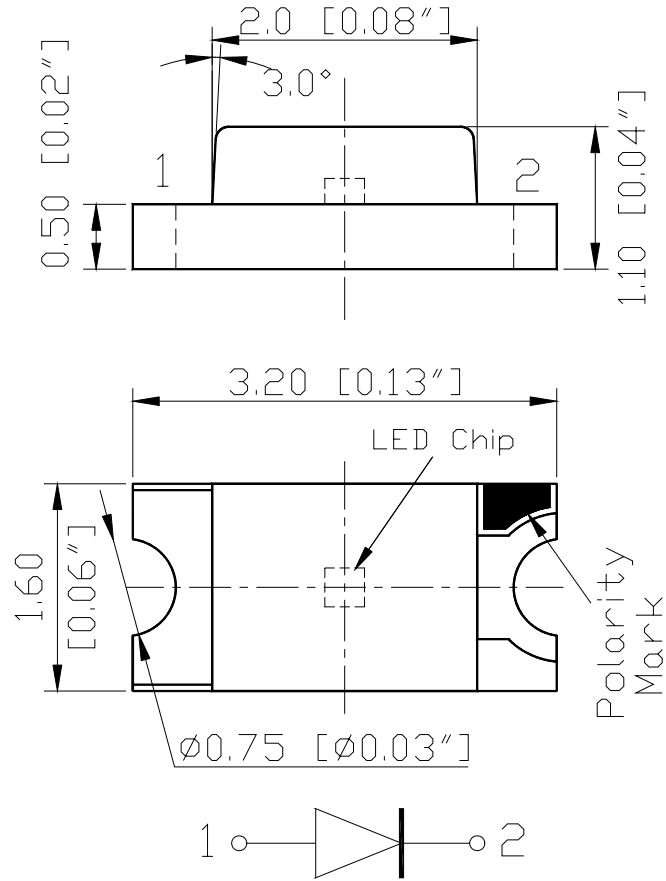

RECOMMEND PAD LAYOUT

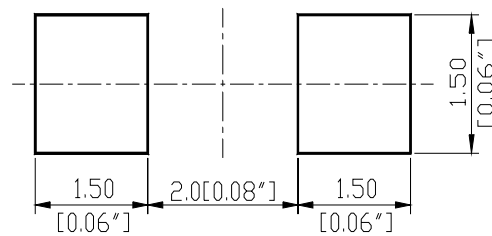



YETDA INDUSTRY LTD.

Descriptions :

- The Chip-LED Taping is much smaller than lead frame type components, thus enable smaller board size, higher packing density, reduced storage space and finally smaller equipment to be obtained.
- Besides, lightweight makes them ideal for miniature application, etc.

- **Soldering heat reliability (DIP):**

Please refer to the following figure :

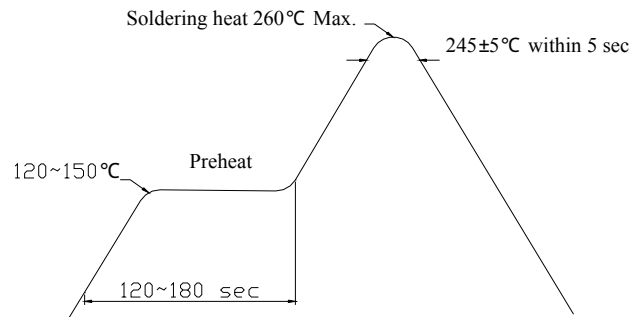

- **Precautions For Use :**

- Over- current- proof

Customer must apply resistors for protection, otherwise slight voltage shift will cause big current change (Burn out will happen)

- Storage

1. The operation of temperature and R.H. are : 5°C ~ 30°C, 60%R.H. Max..
2. Once the package is opened, the products should be used within a week. Otherwise, they should be kept in a dampproof box with desiccating reagent. Considering the tape life, we suggest our customers to use our products within 1.5 year (from production date) .
3. It's recommended to bake before soldering when the package is unsealed after 72 hrs. The condition is : 60°C±5°C for 15hrs.



● **Test Circuit**

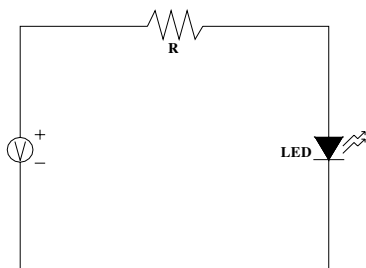

● **Reflow Temp. / Time :**

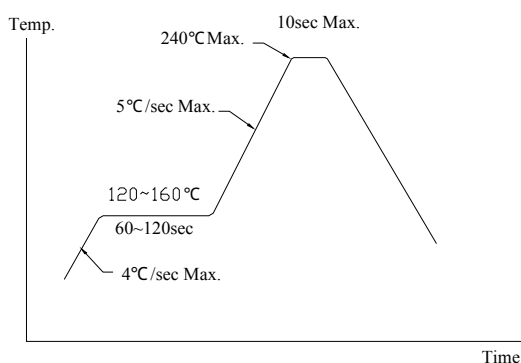

● **Reliability Test Items And Conditions**

The reliability of products shall be satisfied with items listed below.

No.	Items	Test Condition	Test Hours/Cycles	Sample Size
1	Solder Heat	TEMP : 260°C±5°C	5 sec	48 pcs
2	Temperature Cycle	90°C~ 25°C~ -30°C ~ 25°C 30m 5m 30m 5m	300Cycles	48 Pcs
3	Thermal Shick	100°C~ -55°C 10m 10m	100Cycles	48 Pcs
4	Operation Life	If=20mA	1000 Hrs	48 Pcs
5	High Temperature Storage	Temp:90°C	1000Hrs	48 Pcs
6	Low Temperature Storage	Temp:-30°C	1000Hrs	48 Pcs
7	High Temperature/High Humidity	80°C / R.H80%	1000Hrs	48 Pcs



YETDA INDUSTRY LTD.