



Chipsmall Limited consists of a professional team with an average of over 10 year of expertise in the distribution of electronic components. Based in Hongkong, we have already established firm and mutual-benefit business relationships with customers from,Europe,America and south Asia,supplying obsolete and hard-to-find components to meet their specific needs.

With the principle of "Quality Parts,Customers Priority,Honest Operation,and Considerate Service",our business mainly focus on the distribution of electronic components. Line cards we deal with include Microchip,ALPS,ROHM,Xilinx,Pulse,ON,Everlight and Freescale. Main products comprise IC,Modules,Potentiometer,IC Socket,Relay,Connector.Our parts cover such applications as commercial,industrial, and automotives areas.

We are looking forward to setting up business relationship with you and hope to provide you with the best service and solution. Let us make a better world for our industry!



## Contact us

Tel: +86-755-8981 8866 Fax: +86-755-8427 6832

Email & Skype: info@chipsmall.com Web: www.chipsmall.com

Address: A1208, Overseas Decoration Building, #122 Zhenhua RD., Futian, Shenzhen, China



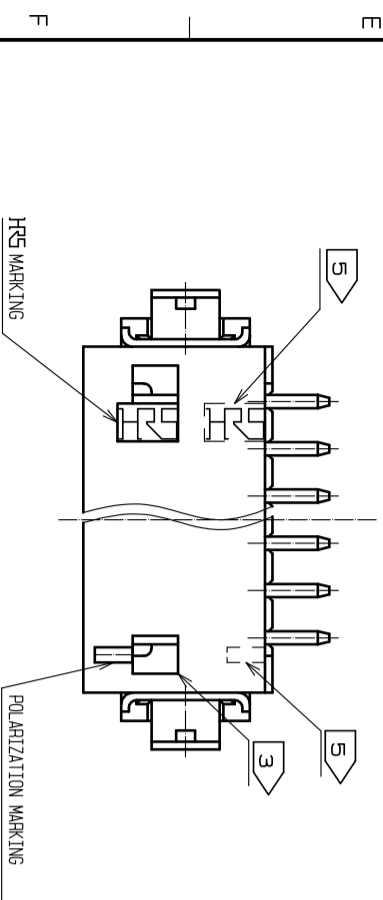
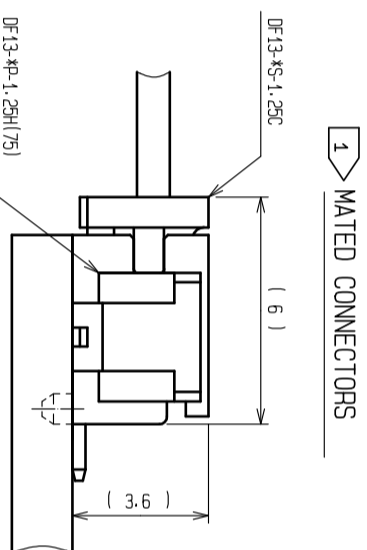
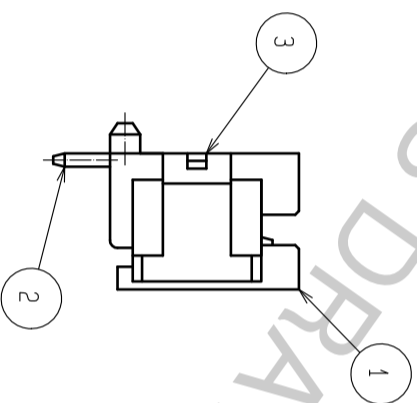
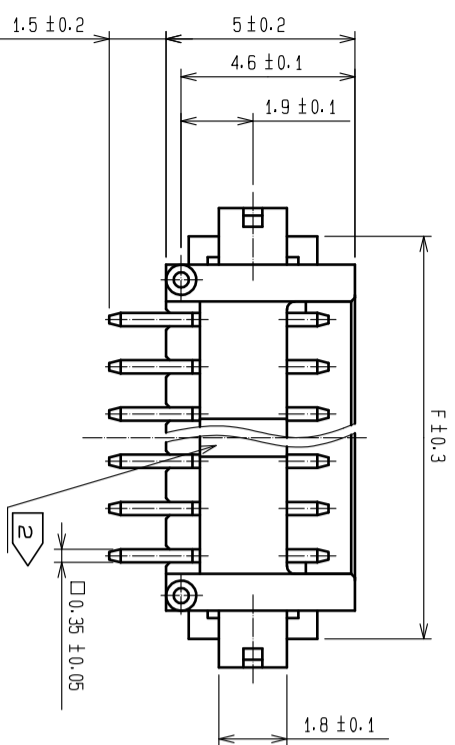
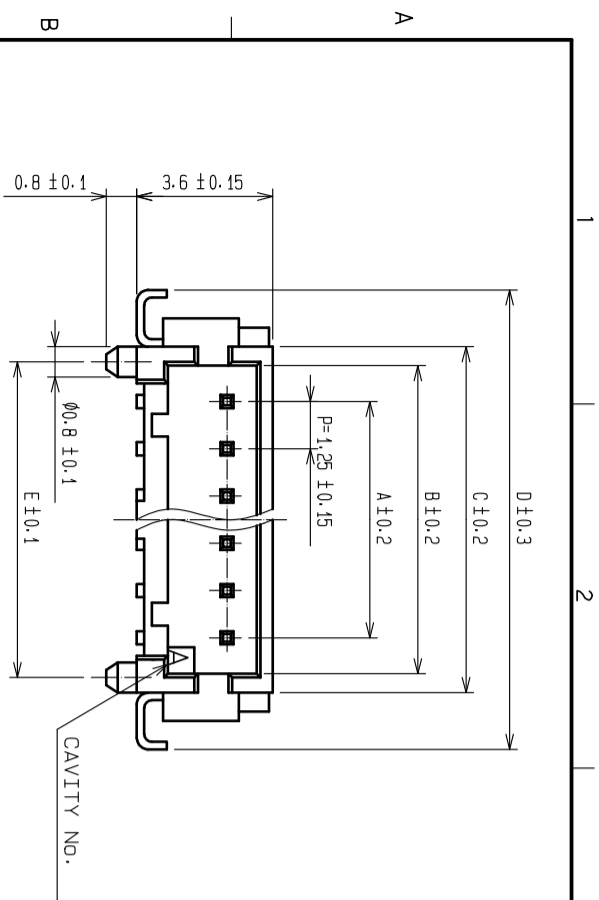

CODE No.	PARTS No.	NUMBER OF CONTACT	A	B	C	D	E	F
CL536-0251-1-75	DF13- 2P-1.25H(75)	2	1.25	3.15	4.15	7.15	3.35	5.65
CL536-0252-4-75	DF13- 3P-1.25H(75)	3	2.5	4.4	5.4	8.4	4.60	6.9
CL536-0253-7-75	DF13- 4P-1.25H(75)	4	3.75	5.65	6.65	9.65	5.85	8.15
CL536-0254-0-75	DF13- 5P-1.25H(75)	5	5.0	6.9	7.9	10.9	7.10	9.40
CL536-0255-2-75	DF13- 6P-1.25H(75)	6	6.25	8.15	9.15	12.15	8.35	10.65
CL536-0256-5-75	DF13- 7P-1.25H(75)	7	7.5	9.4	10.4	13.4	9.60	11.9
CL536-0257-8-75	DF13- 8P-1.25H(75)	8	8.75	10.65	11.65	14.65	10.85	13.15
CL536-0258-0-75	DF13- 9P-1.25H(75)	9	10.0	11.9	12.9	15.9	12.1	14.4
CL536-0259-3-75	DF13-10P-1.25H(75)	10	11.25	13.15	14.15	17.15	13.35	15.65
—	DF13-11P-1.25H(75)	11	12.5	14.4	15.4	18.4	14.6	16.9
CL536-0261-5-75	DF13-12P-1.25H(75)	12	13.75	15.65	16.65	19.65	15.85	18.15
CL536-0263-0-75	DF13-14P-1.25H(75)	14	16.25	18.15	19.15	22.15	18.35	20.65
CL536-0264-3-75	DF13-15P-1.25H(75)	15	17.5	19.4	20.4	23.4	19.6	21.9

RECOMMENDED PATTERN

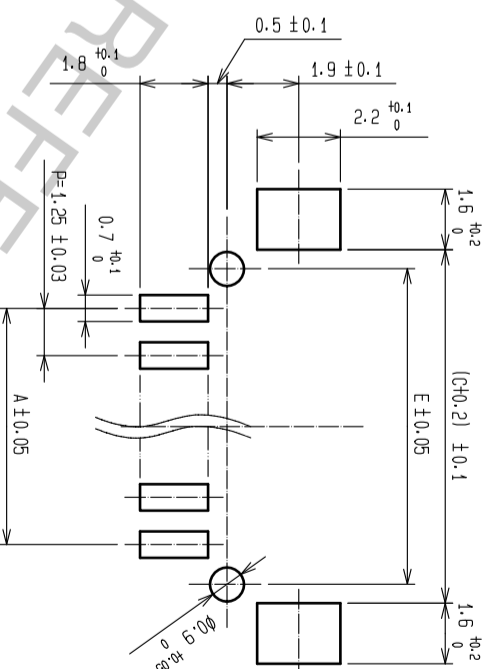

NOTE  
 1: WHEN THIS CONNECTOR MATES WITH DF13-4S-1.25C, THE MATED DEPTH IS 6mm.  
 2: THERE SHALL BE STANDOFF MORE THAN FIVE CONTACTS.  
 3: WHEN THIS CONNECTOR HAS TWO OR THREE CONTACTS, THE LOCK SHALL BE SET AT THE CENTER OF HOUSING. IF MORE THAN FOUR, THE TWO LOCKS SHALL BE SET AS SHOWN ON THIS DRAWING.  
 4: FLATNESS OF LEAD WITH REINFORCED METAL FITTINGS SHALL BE WITHIN 0.1mm.  
 5: WHEN THIS CONNECTOR HAS MORE THAN SEVEN CONTACTS, HRS MARKING AND POLARIZATION MARKING SHIFT TO THE PLACE INDICATING-DOTTED LINES.

NO.	MATERIAL	FINISH	REMARKS	NO.	MATERIAL	FINISH	REMARKS
2	BRASS	SURFACE PLATING: TIN PLATED 1μm min		5	ELASTOMER	GRAY, STOPPER	
1	POLYAMIDE	UNDER PLATING: COPPER PLATE 1μm min		4	R: PVC	ANTI-ELECTRIFICATION-CLEAR-STICK	
		BETIGE: UL94V-0		3	PHOSPHOR BRONZE	SURFACE PLATING: TIN PLATED 1μm min	

  

UNITS	SCALE	COUNT	DESCRIPTION OF REVISIONS	DESIGNED	CHECKED	DATE
mm	5 : 1					

APPROVED	CHECKED	DESIGNED	DRAWING	PART	CODE
HS. OKAWA	TS. FUKUSHIMA	TS. KUMAZAWA	18.03.20	DF13-4P-1.25H(75)	CL536-
			18.03.20		
			18.03.19		
			18.03.08		

510<sub>2</sub>

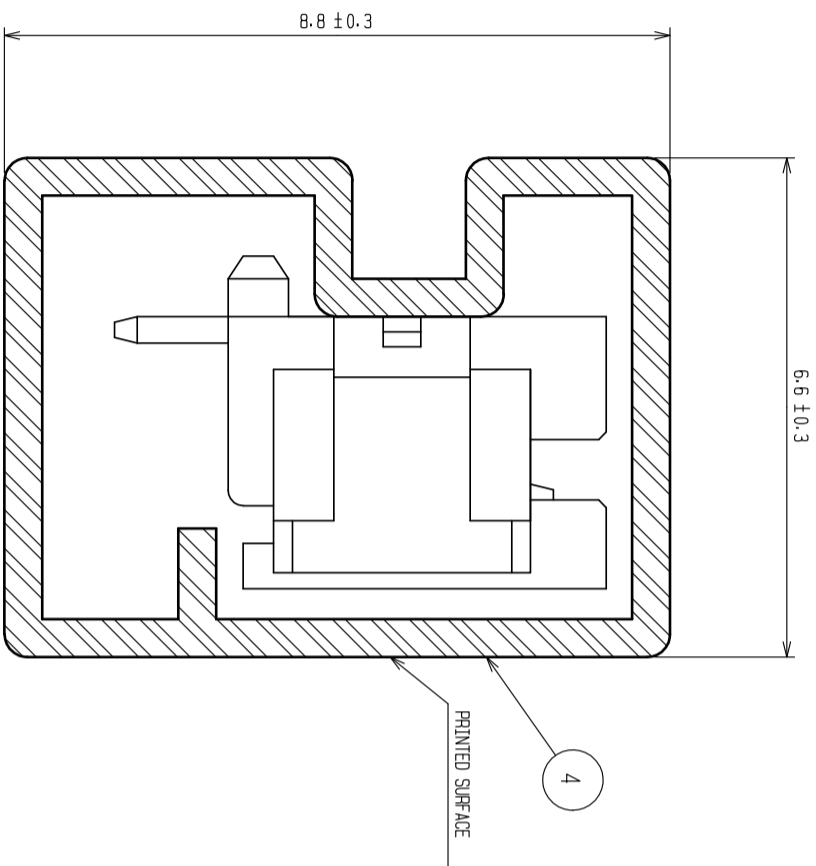
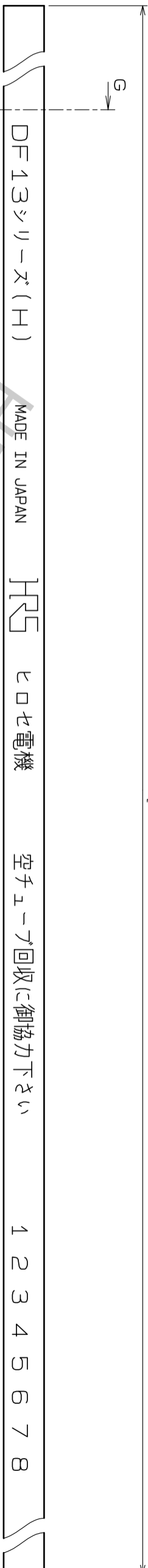
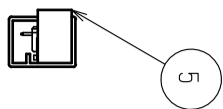

G-G (10:1)

CODE NO.	PARTS NO.	QUANTITY OF CONNECTOR
CL536-0251-1-75	DF13-2P-1.25H(75)	67
CL536-0252-4-75	DF13-3P-1.25H(75)	57
CL536-0253-7-75	DF13-4P-1.25H(75)	49
CL536-0254-0-75	DF13-5P-1.25H(75)	44
CL536-0255-2-75	DF13-6P-1.25H(75)	39
CL536-0256-5-75	DF13-7P-1.25H(75)	36
CL536-0257-8-75	DF13-8P-1.25H(75)	33
CL536-0258-0-75	DF13-9P-1.25H(75)	30
CL536-0259-3-75	DF13-10P-1.25H(75)	28
—	DF13-11P-1.25H(75)	26
CL536-0261-5-75	DF13-12P-1.25H(75)	24
CL536-0263-0-75	DF13-14P-1.25H(75)	21
CL536-0264-3-75	DF13-15P-1.25H(75)	20

NOTES 6 : THE TUBE HAS ONE STOPPER AT EACH END.  
 7 : WARPAGE OF THE TUBE SHALL BE ALLOWED ±2mm PER 510mm.  
 8 : MINIMUM UNIT OF PURCHASE SHALL BE THE QUANTITY OF CONNECTORS IN TUBE.  
 (DIMENSION DELETION)

FORM HC0011-5-8

<b>HRS</b>	DRAWING NO.	EDC-083662-75-00
	PART NO.	DF13-*P-1.25H(75)
	CODE	CL536-