



Chipsmall Limited consists of a professional team with an average of over 10 year of expertise in the distribution of electronic components. Based in Hongkong, we have already established firm and mutual-benefit business relationships with customers from,Europe,America and south Asia,supplying obsolete and hard-to-find components to meet their specific needs.

With the principle of “Quality Parts,Customers Priority,Honest Operation,and Considerate Service”,our business mainly focus on the distribution of electronic components. Line cards we deal with include Microchip,ALPS,ROHM,Xilinx,Pulse,ON,Everlight and Freescale. Main products comprise IC,Modules,Potentiometer,IC Socket,Relay,Connector.Our parts cover such applications as commercial,industrial, and automotives areas.

We are looking forward to setting up business relationship with you and hope to provide you with the best service and solution. Let us make a better world for our industry!



Contact us

Tel: +86-755-8981 8866 Fax: +86-755-8427 6832

Email & Skype: info@chipsmall.com Web: www.chipsmall.com

Address: A1208, Overseas Decoration Building, #122 Zhenhua RD., Futian, Shenzhen, China



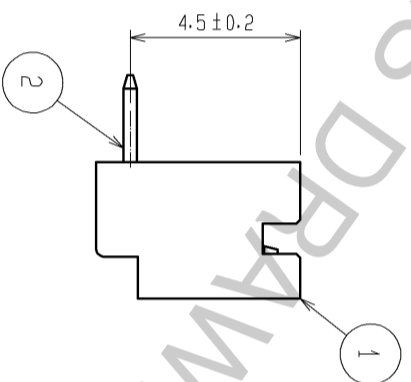
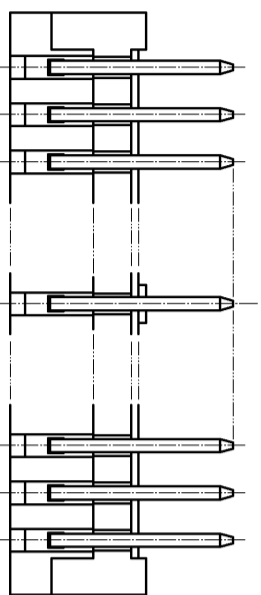
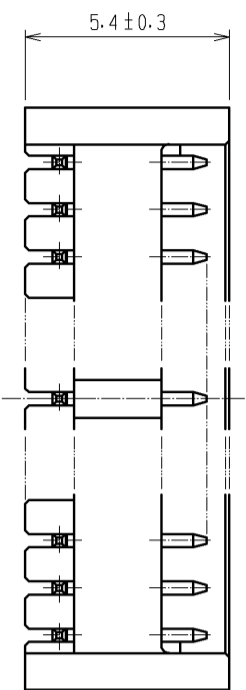
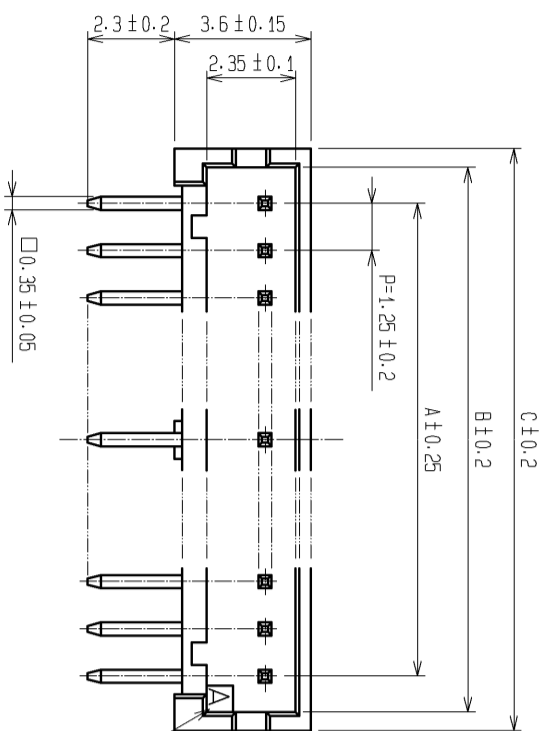

PART NO.	CODE NO.	NUMBER OF CONTACTS	A	B	C
DF13-2P-1.25DS(50)	CL536-0151-7-50	2	1.25	3.15	4.15
DF13-3P-1.25DS(50)	CL536-0152-0-50	3	2.50	4.40	5.40
DF13-4P-1.25DS(50)	CL536-0153-2-50	4	3.75	5.65	6.65
DF13-5P-1.25DS(50)	CL536-0154-5-50	5	5.00	6.90	7.90
DF13-6P-1.25DS(50)	CL536-0155-8-50	6	6.25	8.15	9.15
DF13-7P-1.25DS(50)	CL536-0156-0-50	7	7.50	9.40	10.40
DF13-8P-1.25DS(50)	CL536-0157-3-50	8	8.75	10.65	11.65
DF13-9P-1.25DS(50)	CL536-0158-6-50	9	10.00	11.90	12.90
DF13-10P-1.25DS(50)	CL536-0159-9-50	10	11.25	13.15	14.15
DF13-11P-1.25DS(50)	CL536-0160-8-50	11	12.50	14.40	15.40
DF13-12P-1.25DS(50)	CL536-0161-0-50	12	13.75	15.65	16.65
DF13-14P-1.25DS(50)	CL536-0163-6-50	14	16.25	18.15	19.15
DF13-15P-1.25DS(50)	CL536-0164-9-50	15	17.50	19.40	20.40

APPLICATION FIGURE

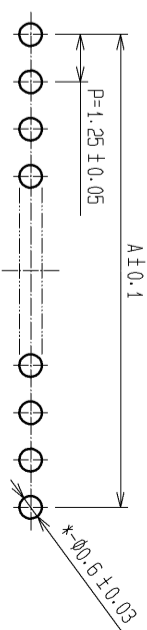
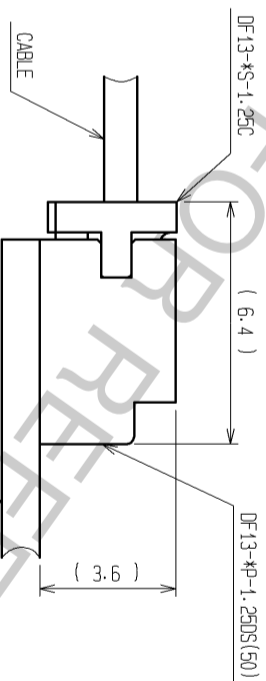

RECOMMENDED PATTERN (BOARD THICKNESS 1mm)

NOTE 1 WHEN THIS CONNECTOR HAS TWO OR THREE CONTACTS, THE LOCK OF CONNECTOR SHALL BE SET AT THE CENTER OF HOUSING. IN CASE THAT THE NUMBER OF CONTACTS IS MORE THAN FOUR, THE TWO LOCKS SHALL BE SET IN ACCORDANCE WITH THE LEFT DRAWINGS.

2 WHEN THIS CONNECTOR MATES WITH DF13-4S-1.25C, THE MATING LENGTH IS 6.4mm.

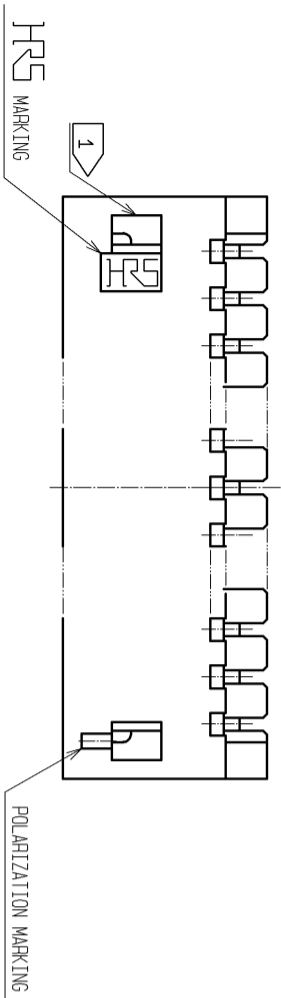

NO.	MATERIAL	FINISH	REMARKS	NO.	MATERIAL	FINISH	REMARKS
2	BRASS	SURFACE:GOLD PLATED 0.2µm min. UNDER:NICKLE PLATED 0.5µm min.		4	ELASTOMER	STOPPER, GRAY	
1	POLYAMIDE	BEIGE(NATURAL), UL94V-0		3	P S	ELECTROSTATIC PROTECTION, CLEAR	

UNITS	SCALE	COUNT	DESCRIPTION OF REVISIONS	DESIGNED	CHECKED	DATE
mm	5 : 1					

HRS HIROSE ELECTRIC CO., LTD.

APPROVED	CHECKED	DESIGNED	DRAWN	NO.	PART NO.	CODE
TS. SAKATA	TS. KUMAZAWA	SN. KOBAYASHI	YK. NAKATSU	08.11.17	08.11.14	08.11.14

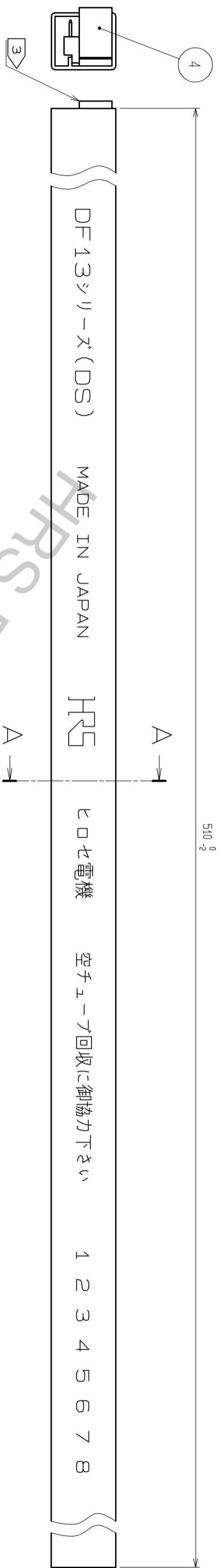

A-A (10:1)

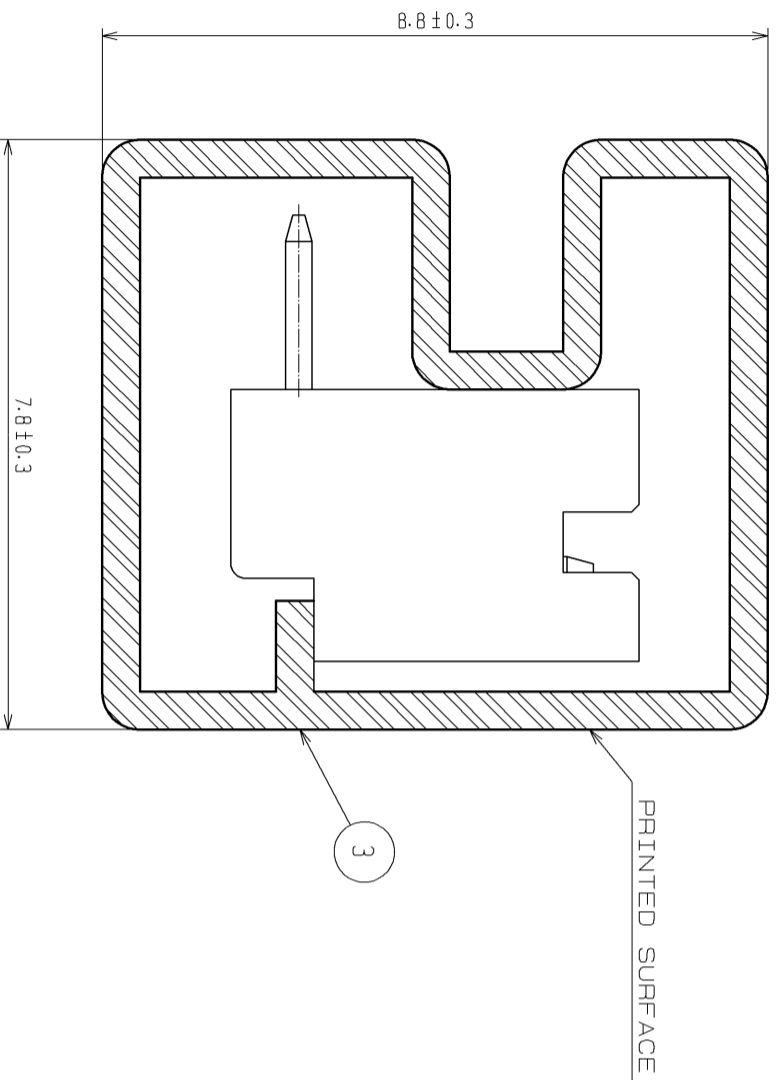

PARTS No.	CODE No.	NUMBER OF CONTACTS	QUANTITY OF CONNECTOR
DF13-2P-1.25DS(50)	CL536-0151-7-50	2	115
DF13-3P-1.25DS(50)	CL536-0152-0-50	3	89
DF13-4P-1.25DS(50)	CL536-0153-2-50	4	72
DF13-5P-1.25DS(50)	CL536-0154-5-50	5	61
DF13-6P-1.25DS(50)	CL536-0155-8-50	6	52
DF13-7P-1.25DS(50)	CL536-0156-0-50	7	46
DF13-8P-1.25DS(50)	CL536-0157-3-50	8	41
DF13-9P-1.25DS(50)	CL536-0158-6-50	9	37
DF13-10P-1.25DS(50)	CL536-0159-9-50	10	34
DF13-11P-1.25DS(50)	CL536-0160-8-50	11	31
DF13-12P-1.25DS(50)	CL536-0161-0-50	12	29
DF13-14P-1.25DS(50)	CL536-0163-6-50	14	25
DF13-15P-1.25DS(50)	CL536-0164-9-50	15	23

NOTE 3: MAGAZINE CASE HAS ONE STOPPER AT EACH END.
 4: THOSE CONNECTORS SHALL BE ON SALED IN ACCORDANCE WITH THE MULTIPLE QUANTITY OF CONNECTORS.

FORM HC0011-5-8

HRS		DRAWING NO.	EDC3-162420-04
		PART NO.	DF13-*P-1.25DS(50)
HRS		CODE NO.	CL536-
		NO.	2