



Chipsmall Limited consists of a professional team with an average of over 10 year of expertise in the distribution of electronic components. Based in Hongkong, we have already established firm and mutual-benefit business relationships with customers from,Europe,America and south Asia,supplying obsolete and hard-to-find components to meet their specific needs.

With the principle of "Quality Parts,Customers Priority,Honest Operation,and Considerate Service",our business mainly focus on the distribution of electronic components. Line cards we deal with include Microchip,ALPS,ROHM,Xilinx,Pulse,ON,Everlight and Freescale. Main products comprise IC,Modules,Potentiometer,IC Socket,Relay,Connector.Our parts cover such applications as commercial,industrial, and automotives areas.

We are looking forward to setting up business relationship with you and hope to provide you with the best service and solution. Let us make a better world for our industry!



Contact us

Tel: +86-755-8981 8866 Fax: +86-755-8427 6832

Email & Skype: info@chipsmall.com Web: www.chipsmall.com

Address: A1208, Overseas Decoration Building, #122 Zhenhua RD., Futian, Shenzhen, China



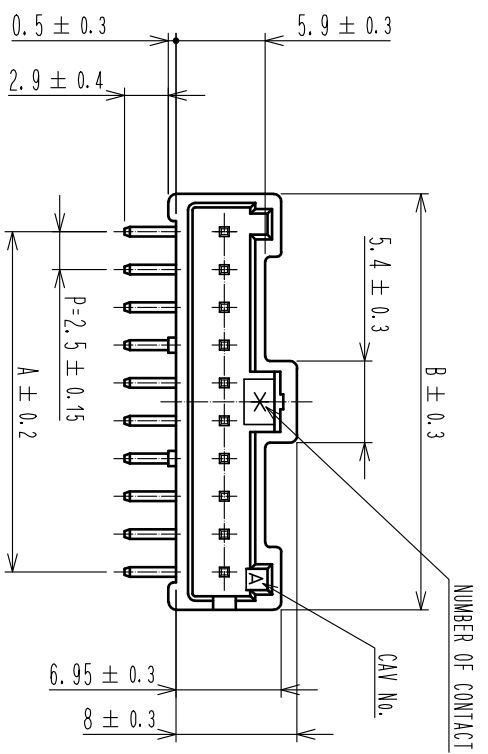

RECOMMENDED PCB LAYOUT(5:1)
(PCB THICKNESS:1.6±0.1)

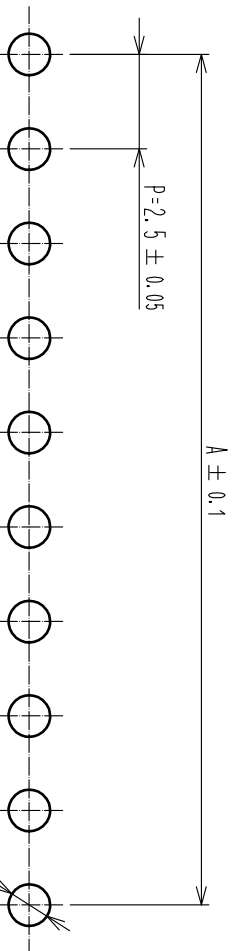

PART NO.	CODE NO.	NUMBER OF CONTACT	A	B
DF1E-2P-2.5DS(35)	CL541-0985-0-35	2	2.5	7.5
DF1E-3P-2.5DS(35)	CL541-0986-3-35	3	5	10
DF1E-4P-2.5DS(35)	CL541-0987-6-35	4	7.5	12.5
DF1E-5P-2.5DS(35)	CL541-0988-9-35	5	10	15
DF1E-6P-2.5DS(35)	CL541-0989-1-35	6	12.5	17.5
DF1E-7P-2.5DS(35)	CL541-0990-0-35	7	15	20
DF1E-8P-2.5DS(35)	CL541-0991-3-35	8	17.5	22.5
DF1E-9P-2.5DS(35)	CL541-0992-6-35	9	20	25
DF1E-10P-2.5DS(35)	CL541-0993-9-35	10	22.5	27.5
DF1E-11P-2.5DS(35)	CL541-0994-1-35	11	25	30
DF1E-12P-2.5DS(35)	CL541-0995-4-35	12	27.5	32.5
DF1E-13P-2.5DS(35)	CL541-0996-7-35	13	30	35
DF1E-14P-2.5DS(35)	CL541-0997-0-35	14	32.5	37.5
DF1E-15P-2.5DS(35)	CL541-0998-2-35	15	35	40

APPLICATION DIAGRAM(4:1)

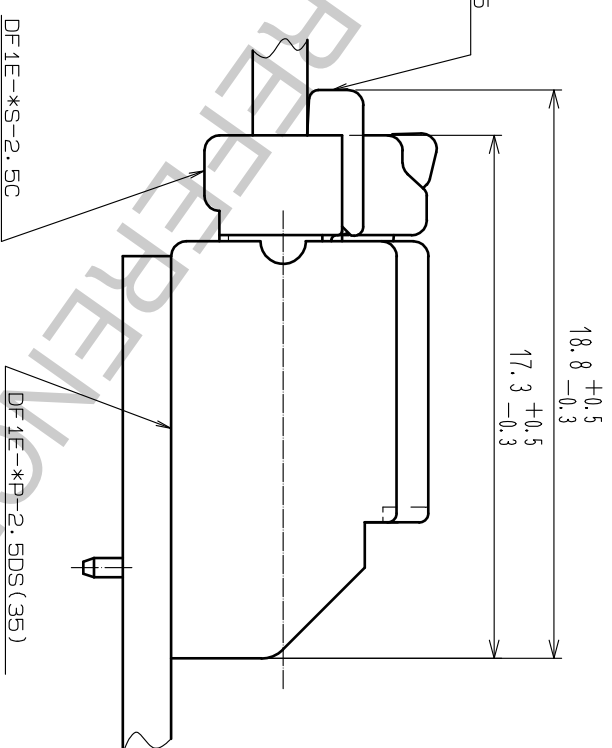
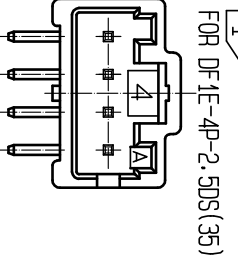
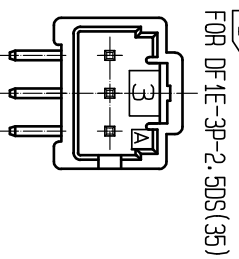
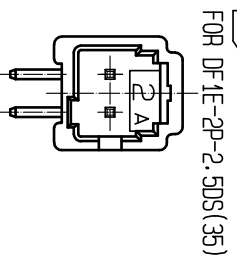
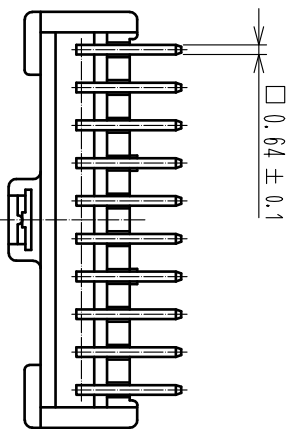
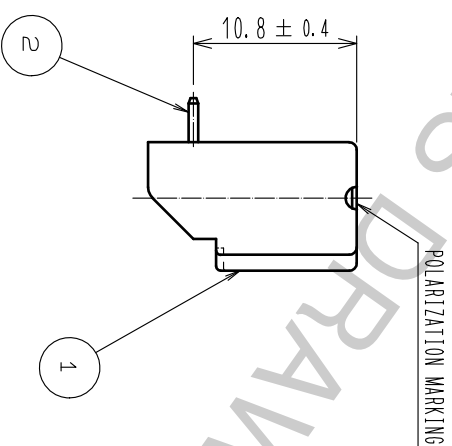
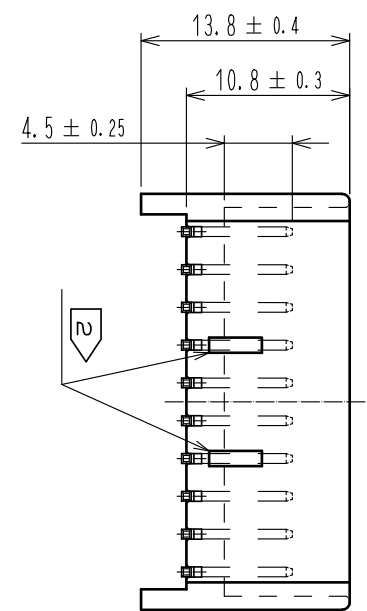

- NOTES
- 1 CONFIGURATION OF DF1E-2P-2.5DS(35), DF1E-3P-2.5DS(35) AND DF1E-4P-2.5DS(35).
 - 2 AND 3 OF CONTACTS MAKE DRAWING FORM (PROJECTION) UNNECESSARY, AND 4 OF CONTACTS CONSIDERED AS ONE PROJECTION IN THE CENTER.
 3. UL (FILE NO. E52653).
 - C-UL (FILE NO. E52653) APPROVED PRODUCT.



NO.	MATERIAL	FINISH . REMARKS	NO.	MATERIAL	FINISH . REMARKS
1	POLYAMIDE	NATURAL (BEIGE), UL94V-0	2	BRASS	SURFACE:TIN PLATED 1µm min UNDER PLATING:NICKEL PLATED 0.5µm min

UNITS	SCALE	COUNT	DESCRIPTION OF REVISIONS	DESIGNED	CHECKED	DATE
mm	2 : 1	1				

APPROVED	CHECKED	DESIGNED	DRAWN	DRAWING NO.	PART NO.	CODE
KI. AKIYAMA	T.S. FUKUSHIMA	T.S. KIMAZAWA	M. SAKIYURA	15.05.29	15.05.29	15.05.28

EDC-161951-35-00
DF1E-*P-2.5DS(35)
CL541-