



Chipsmall Limited consists of a professional team with an average of over 10 year of expertise in the distribution of electronic components. Based in Hongkong, we have already established firm and mutual-benefit business relationships with customers from,Europe,America and south Asia,supplying obsolete and hard-to-find components to meet their specific needs.

With the principle of “Quality Parts,Customers Priority,Honest Operation,and Considerate Service”,our business mainly focus on the distribution of electronic components. Line cards we deal with include Microchip,ALPS,ROHM,Xilinx,Pulse,ON,Everlight and Freescale. Main products comprise IC,Modules,Potentiometer,IC Socket,Relay,Connector.Our parts cover such applications as commercial,industrial, and automotives areas.

We are looking forward to setting up business relationship with you and hope to provide you with the best service and solution. Let us make a better world for our industry!



Contact us

Tel: +86-755-8981 8866 Fax: +86-755-8427 6832

Email & Skype: info@chipsmall.com Web: www.chipsmall.com

Address: A1208, Overseas Decoration Building, #122 Zhenhua RD., Futian, Shenzhen, China



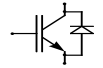

Höchstzulässige Werte / maximum rated values

Elektrische Eigenschaften / electrical properties

Kollektor Emitter Sperrspannung collector emitter voltage	$T_{vj} = 25^{\circ}\text{C}$	V_{CES}	1200	V
Kollektor Dauergleichstrom DC collector current	$T_c = 80^{\circ}\text{C}$ $T_c = 25^{\circ}\text{C}$	$I_{C, nom}$ I_C	300 480	A A
Periodischer Kollektor Spitzenstrom repetitive peak collector current	$t_p = 1\text{ms}, T_c = 80^{\circ}\text{C}$	I_{CRM}	600	A
Gesamt Verlustleistung total power dissipation	$T_c = 25^{\circ}\text{C}; \text{ Transistor}$	P_{tot}	1470	W
Gate Emitter Spitzenspannung gate emitter peak voltage		V_{GES}	+/- 20	V
Dauergleichstrom DC forward current		I_F	300	A
Periodischer Spitzenstrom repetitive peak forward current	$t_p = 1\text{ms}$	I_{FRM}	600	A
Grenzlastintegral I^2t value	$V_R = 0\text{V}, t_p = 10\text{ms}, T_{vj} = 125^{\circ}\text{C}$	I^2t	19	kA^2s
Isolations Prüfspannung insulation test voltage	RMS, $f = 50\text{Hz}, t = 1\text{min.}$	V_{ISOL}	2,5	kV

Charakteristische Werte / characteristic values

Transistor Wechselrichter / transistor inverter

			min.	typ.	max.	
Kollektor Emitter Sättigungsspannung collector emitter saturation voltage	$I_C = 300\text{A}, V_{GE} = 15\text{V}, T_{vj} = 25^{\circ}\text{C}$	V_{CESat}	-	1,7	2,15	V
	$I_C = 300\text{A}, V_{GE} = 15\text{V}, T_{vj} = 125^{\circ}\text{C}$		-	2,0	-	V
Gate Schwellenspannung gate threshold voltage	$I_C = 12\text{mA}, V_{CE} = V_{GE}, T_{vj} = 25^{\circ}\text{C}$	$V_{GE(th)}$	5,0	5,8	6,5	V
Gateladung gate charge	$V_{GE} = -15\text{V} \dots +15\text{V}$	Q_G	-	2,8	-	μC
Eingangskapazität input capacitance	$f = 1\text{MHz}, T_{vj} = 25^{\circ}\text{C}, V_{CE} = 25\text{V}, V_{GE} = 0\text{V}$	C_{ies}	-	21	-	nF
Rückwirkungskapazität reverse transfer capacitance	$f = 1\text{MHz}, T_{vj} = 25^{\circ}\text{C}, V_{CE} = 25\text{V}, V_{GE} = 0\text{V}$	C_{res}	-	0,85	-	nF
Kollektor Emitter Reststrom collector emitter cut off current	$V_{CE} = 1200\text{V}, V_{GE} = 0\text{V}, T_{vj} = 25^{\circ}\text{C}$	I_{CES}	-	-	5	mA
Gate Emitter Reststrom gate emitter leakage current	$V_{CE} = 0\text{V}, V_{GE} = 20\text{V}, T_{vj} = 25^{\circ}\text{C}$	I_{GES}	-	-	400	nA

prepared by: MOD-D2; Mark Münzer

date of publication: 2002-10-02

approved: SM TM; Wilhelm Rusche

revision: 3.0



Charakteristische Werte / characteristic values

Transistor Wechselrichter / transistor inverter

			min.	typ.	max.	
Einschaltverzögerungszeit (induktive Last) turn on delay time (inductive load)	$I_C = 300A, V_{CC} = 600V$ $V_{GE} = \pm 15V, R_G = 2,4\Omega, T_{vj} = 25^\circ C$	$t_{d,on}$	-	0,25	-	μs
	$V_{GE} = \pm 15V, R_G = 2,4\Omega, T_{vj} = 125^\circ C$		-	0,30	-	μs
Anstiegszeit (induktive Last) rise time (inductive load)	$I_C = 300A, V_{CC} = 600V$ $V_{GE} = \pm 15V, R_G = 2,4\Omega, T_{vj} = 25^\circ C$	t_r	-	0,09	-	μs
	$V_{GE} = \pm 15V, R_G = 2,4\Omega, T_{vj} = 125^\circ C$		-	0,10	-	μs
Abschaltverzögerungszeit (induktive Last) turn off delay time (inductive load)	$I_C = 300A, V_{CC} = 600V$ $V_{GE} = \pm 15V, R_G = 2,4\Omega, T_{vj} = 25^\circ C$	$t_{d,off}$	-	0,55	-	μs
	$V_{GE} = \pm 15V, R_G = 2,4\Omega, T_{vj} = 125^\circ C$		-	0,65	-	μs
Fallzeit (induktive Last) fall time (inductive load)	$I_C = 300A, V_{CC} = 600V$ $V_{GE} = \pm 15V, R_G = 2,4\Omega, T_{vj} = 25^\circ C$	t_f	-	0,13	-	μs
	$V_{GE} = \pm 15V, R_G = 2,4\Omega, T_{vj} = 125^\circ C$		-	0,18	-	μs
Einschaltverlustenergie pro Puls turn on energy loss per pulse	$I_C = 300A, V_{CC} = 600V, L_\sigma = 80nH$ $V_{GE} = \pm 15V, R_G = 2,4\Omega, T_{vj} = 125^\circ C$	E_{on}	-	25	-	mJ
Ausschaltverlustenergie pro Puls turn off energy loss per pulse	$I_C = 300A, V_{CC} = 600V, L_\sigma = 80nH$ $V_{GE} = \pm 15V, R_G = 2,4\Omega, T_{vj} = 125^\circ C$	E_{off}	-	44	-	mJ
Kurzschlussverhalten SC data	$t_p \leq 10\mu s, V_{GE} \leq 15V, T_{vj} \leq 125^\circ C$ $V_{CC} = 900V, V_{CEmax} = V_{CES} - L_{\sigma CE} \cdot di/dt$	I_{SC}	-	1200	-	A
Modulinduktivität stray inductance module		$L_{\sigma CE}$	-	20	-	nH
Leitungswiderstand, Anschluss-Chip lead resistance, terminal-chip	$T_c = 25^\circ C$	$R_{CC/EE}$	-	0,7	-	m Ω

Charakteristische Werte / characteristic values

Inversdiode / free-wheel diode

Durchlassspannung forward voltage	$I_F = 300A, V_{GE} = 0V, T_{vj} = 25^\circ C$	V_F	-	1,65	2,15	V
	$I_F = 300A, V_{GE} = 0V, T_{vj} = 125^\circ C$		-	1,65	-	V
Rückstromspitze peak reverse recovery current	$I_F = 300A, -di_F/dt = 3000A/\mu s$ $V_R = 600V, V_{GE} = -15V, T_{vj} = 25^\circ C$	I_{RM}	-	210	-	A
	$V_R = 600V, V_{GE} = -15V, T_{vj} = 125^\circ C$		-	270	-	A
Sperrverzögerungsladung recovered charge	$I_F = 300A, -di_F/dt = 3000A/\mu s$ $V_R = 600V, V_{GE} = -15V, T_{vj} = 25^\circ C$	Q_r	-	30	-	μC
	$V_R = 600V, V_{GE} = -15V, T_{vj} = 125^\circ C$		-	56	-	μC
Ausschaltenergie pro Puls reverse recovery energy	$I_F = 300A, -di_F/dt = 3000A/\mu s$ $V_R = 600V, V_{GE} = -15V, T_{vj} = 25^\circ C$	E_{rec}	-	14	-	mJ
	$V_R = 600V, V_{GE} = -15V, T_{vj} = 125^\circ C$		-	26	-	mJ

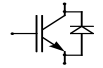

Charakteristische Werte / characteristic values

Chopperdiode / chopper diode

Durchlassspannung forward voltage	$I_F=400A, V_{GE}=0V, T_{vj}=25^\circ C$	V_F	-	1,65	2,15	V
	$I_F=400A, V_{GE}=0V, T_{vj}=125^\circ C$		-	1,65	-	V
Rückstromspitze peak reverse recovery current	$I_F=400A, -di_F/dt=4000A/\mu s$	I_{RM}	-	280	-	A
	$V_R=600V, V_{GE}=-15V, T_{vj}=25^\circ C$ $V_R=600V, V_{GE}=-15V, T_{vj}=125^\circ C$		-	360	-	A
Sperrverzögerungsladung recovered charge	$I_F=400A, -di_F/dt=4000A/\mu s$	Q_r	-	40	-	μC
	$V_R=600V, V_{GE}=-15V, T_{vj}=25^\circ C$ $V_R=600V, V_{GE}=-15V, T_{vj}=125^\circ C$		-	75	-	μC
Ausschaltenergie pro Puls reverse recovery energy	$I_F=400A, -di_F/dt=4000A/\mu s$	E_{rec}	-	18	-	mJ
	$V_R=600V, V_{GE}=-15V, T_{vj}=25^\circ C$ $V_R=600V, V_{GE}=-15V, T_{vj}=125^\circ C$		-	34	-	mJ

Thermische Eigenschaften / thermal properties

Innerer Wärmewiderstand; DC thermal resistance, junction to case; DC	Transistor Wechler. / transistor inverter	R_{thJC}	-	-	0,085	K/W
	Inversdiode / free wheel diode		-	-	0,150	K/W
	Chopper Diode / chopper diode		-	-	0,125	K/W
Übergangs Wärmewiderstand thermal resistance, case to heatsink	pro Modul / per module $\lambda_{Paste}=1W/m^*K / \lambda_{grease}=1W/m^*K$	R_{thCK}	-	0,010	-	K/W
Höchstzulässige Sperrschichttemp. maximum junction temperature		$T_{vj\ max}$	-	-	150	$^\circ C$
Betriebstemperatur operation temperature		$T_{vj\ op}$	-40	-	125	$^\circ C$
Lagertemperatur storage temperature		T_{stg}	-40	-	125	$^\circ C$

Mechanische Eigenschaften / mechanical properties

Gehäuse, siehe Anlage case, see appendix						
Innere Isolation internal insulation				Al_2O_3		
CTI comperative tracking index				425		
Anzugsdrehmoment, mech. Befestigung mounting torque	Schraube M6 / screw M6	M	3,0	-	6,0	Nm
Anzugsdrehmoment, elektr. Anschlüsse terminal connection torque	Anschlüsse /terminals M6	M	2,5	-	5,0	Nm
Gewicht weight		G		340		g

Mit dieser technischen Information werden Halbleiterbauelemente spezifiziert, jedoch keine Eigenschaften zugesichert. Sie gilt in Verbindung mit den zugehörigen technischen Erläuterungen.

This technical information specifies semiconductor devices but promises no characteristics. It is valid with the belonging technical notes.



Ausgangskennlinie (typisch)
output characteristic (typical)

$I_C = f(V_{CE})$
 $V_{GE} = 15V$

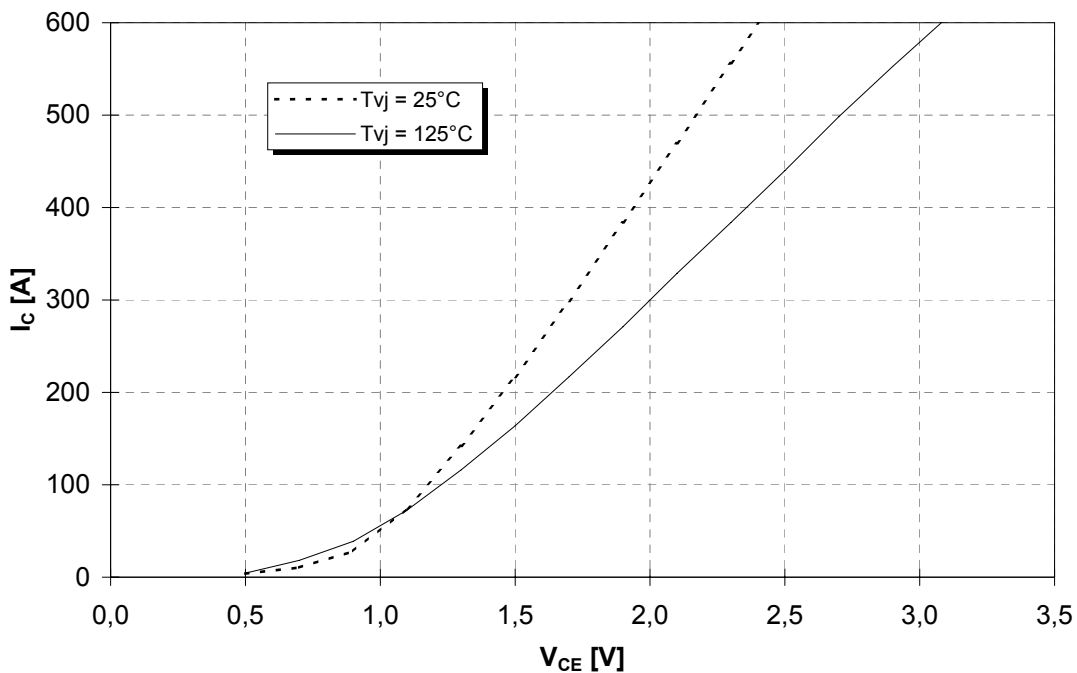

Ausgangskennlinienfeld (typisch)
output characteristic (typical)

$I_C = f(V_{CE})$
 $T_{vj} = 125^\circ C$

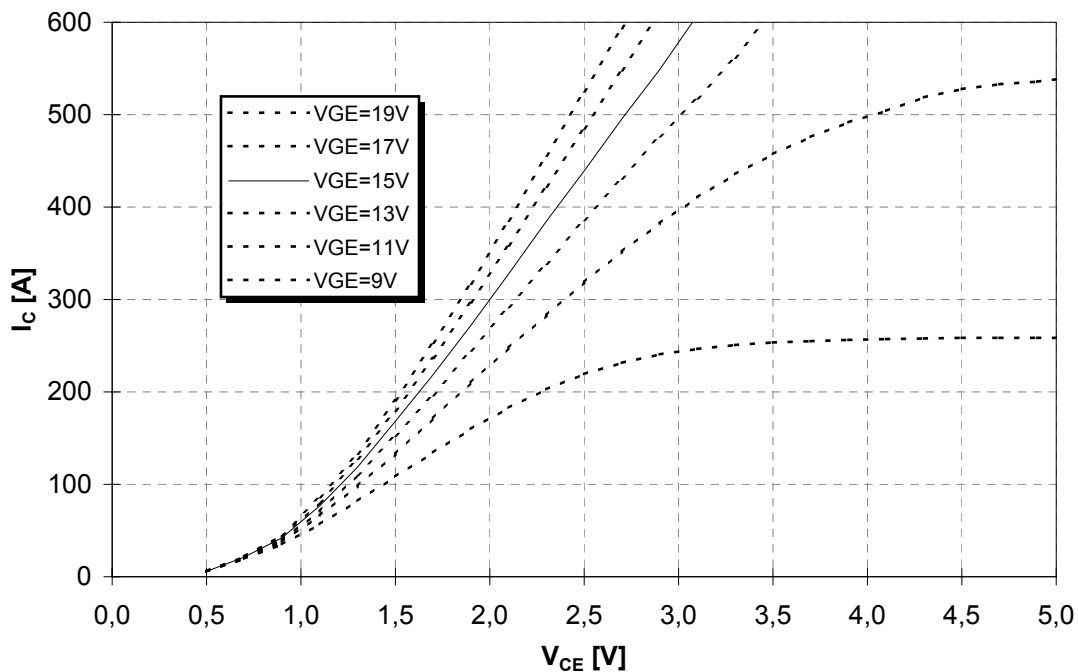



Übertragungscharakteristik (typisch)
transfer characteristic (typical)

$I_C = f(V_{GE})$
 $V_{CE} = 20V$

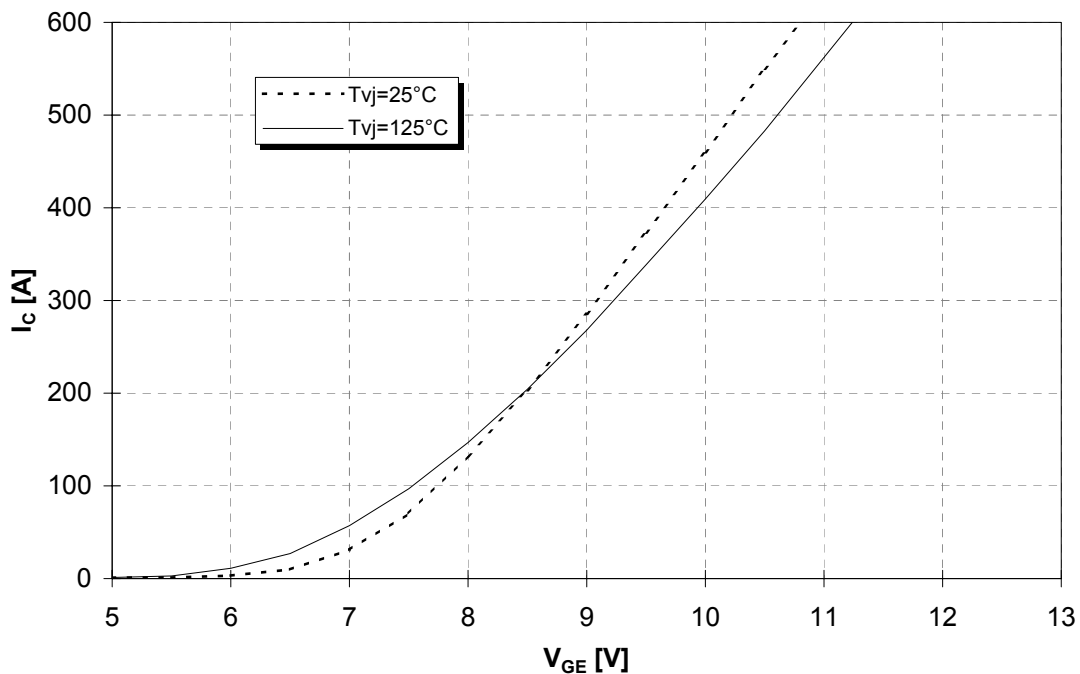

Durchlasskennlinie der Dioden (typisch)
forward characteristic of diodes (typical)

$I_F = f(V_F)$

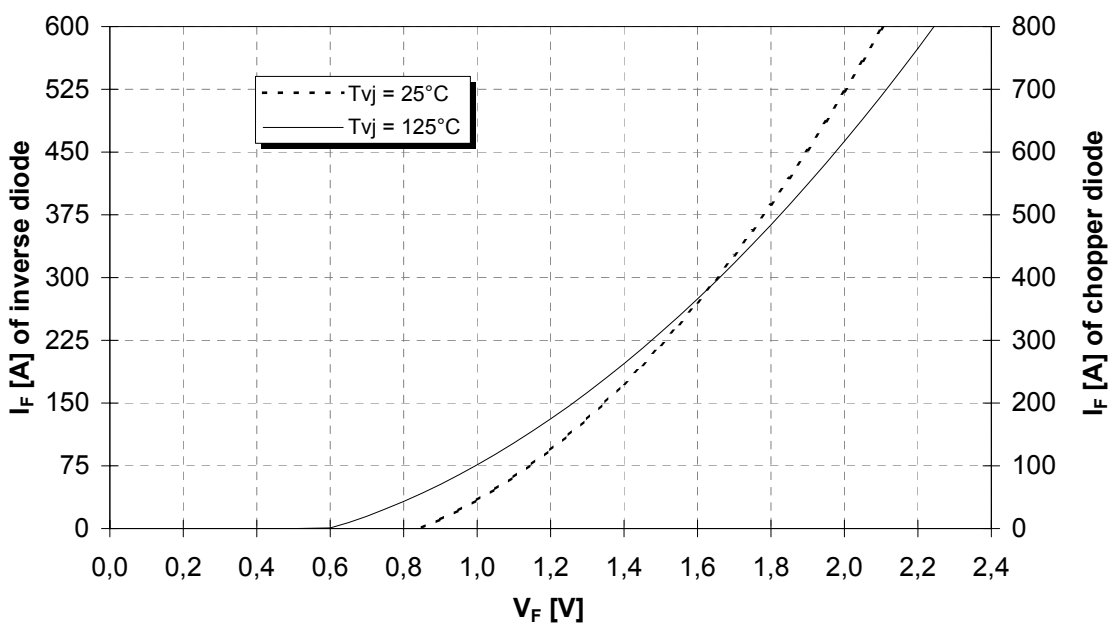



Schaltverluste (typisch)
Switching losses (typical)

$E_{on} = f(I_C)$, $E_{off} = f(I_C)$, $E_{rec} = f(I_C)$
 $V_{GE} = \pm 15V$, $R_G = 2,4\Omega$, $V_{CE} = 600V$, $T_{vj} = 125^\circ C$

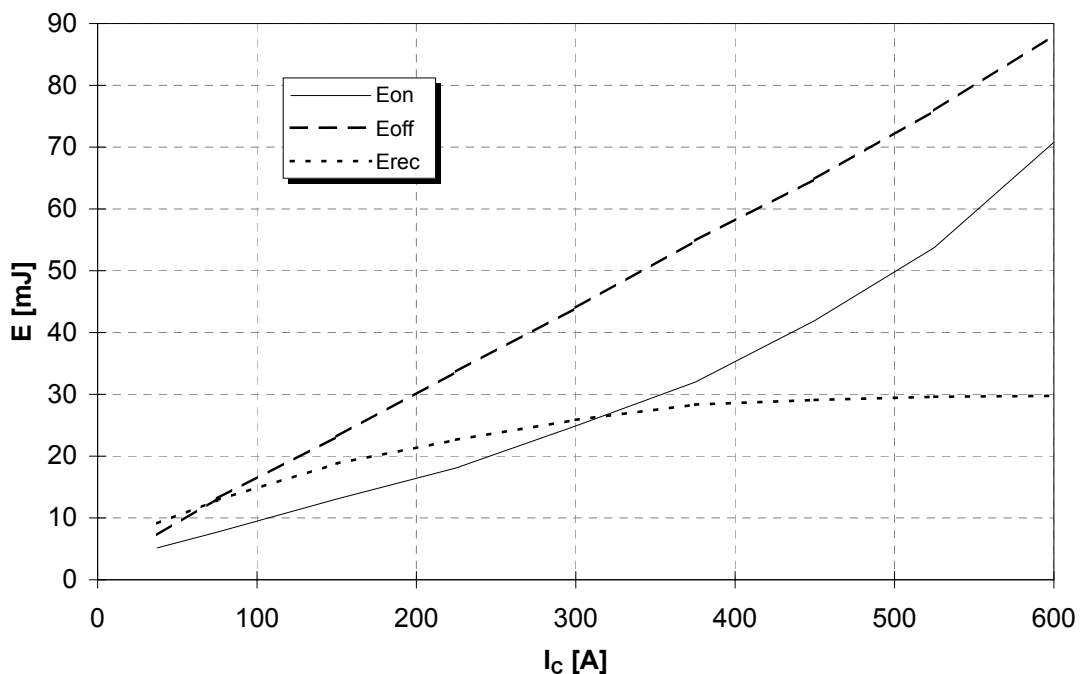

Schaltverluste (typisch)
Switching losses (typical)

$E_{on} = f(R_G)$, $E_{off} = f(R_G)$, $E_{rec} = f(R_G)$
 $V_{GE} = \pm 15V$, $I_C = 300A$, $V_{CE} = 600V$, $T_{vj} = 125^\circ C$

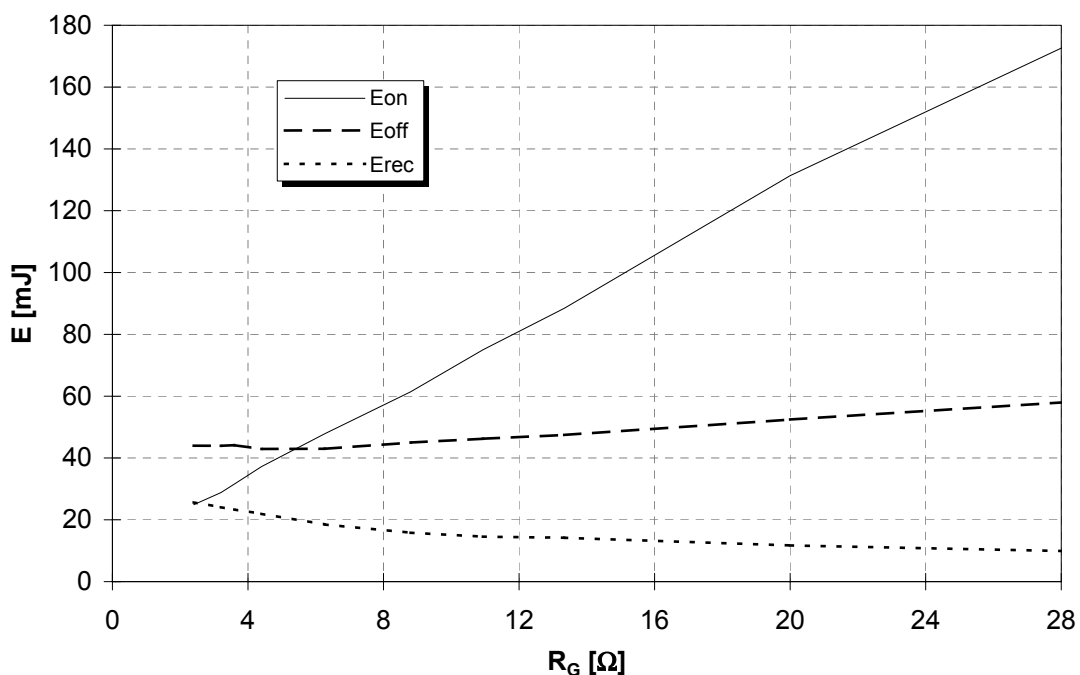

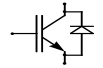

Transienter Wärmewiderstand
Transient thermal impedance

$$Z_{thJC} = f(t)$$

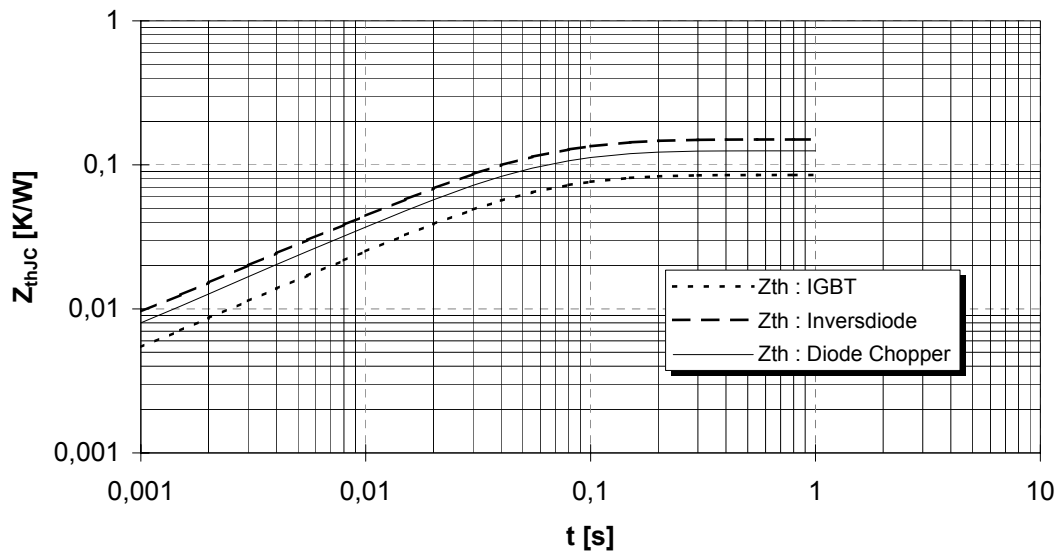

i	1	2	3	4
r_i [K/kW] : IGBT	35,73	42,82	4,84	1,61
τ_i [s] : IGBT	6,499E-02	2,601E-02	2,364E-03	1,187E-05
r_i [K/kW] : Inversdiode	62,99	75,66	8,52	2,83
τ_i [s] : Inversdiode	6,499E-02	2,601E-02	2,364E-03	1,187E-05
r_i [K/kW] : Chopper Diode	52,51	63,02	7,10	2,37
τ_i [s] : Chopper Diode	6,499E-02	2,601E-02	2,364E-03	1,187E-05

Sicherer Arbeitsbereich (RBSOA)

Reverse bias safe operation area (RBSOA)

$$V_{GE} = \pm 15V, T_{vj} = 125^\circ C, R_G = 2,4\Omega$$

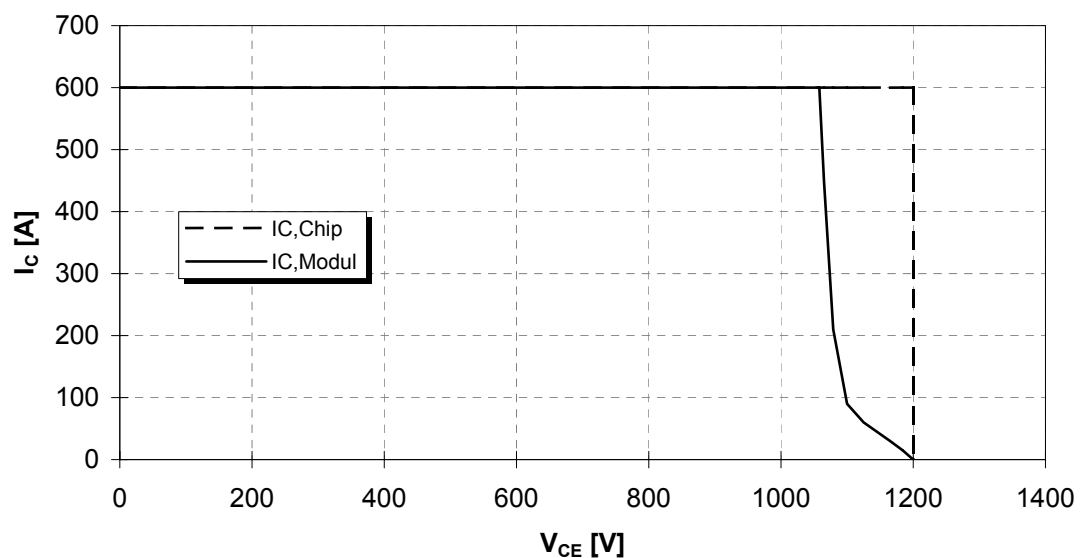

IGBT-Module
IGBT-Modules

DF300R12KE3

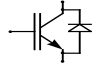

Gehäusemaße / Schaltbild Package outline / Circuit diagram

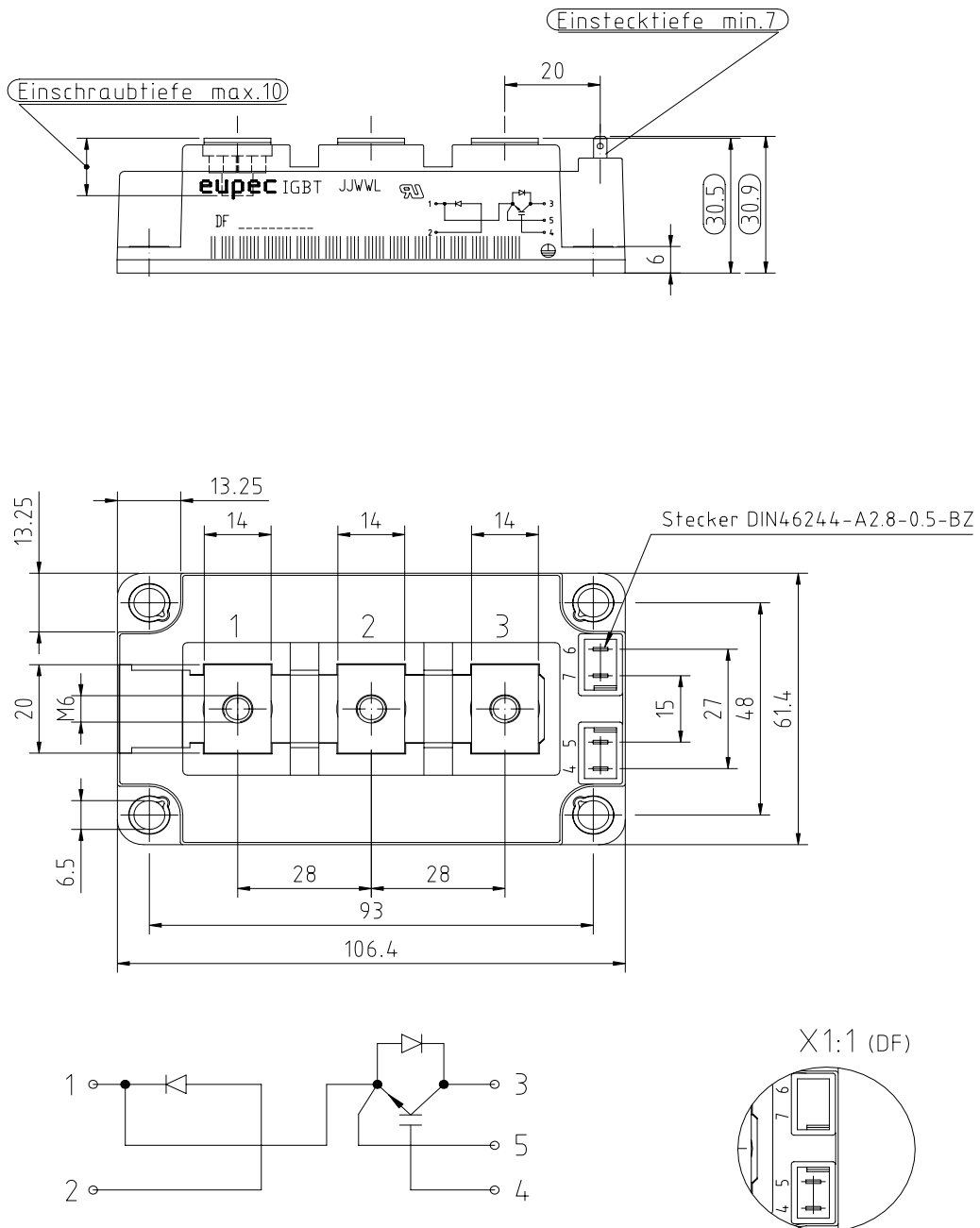

Kriechstrecke creepage distance			20	mm
Luftstrecke clearance distance			11	mm

Nutzungsbedingungen

Die in diesem Produktdatenblatt enthaltenen Daten sind ausschließlich für technisch geschultes Fachpersonal bestimmt. Die Beurteilung der Geeignetheit dieses Produktes für die von Ihnen anvisierte Anwendung sowie die Beurteilung der Vollständigkeit der bereitgestellten Produktdaten für diese Anwendung obliegt Ihnen bzw. Ihren technischen Abteilungen.

In diesem Produktdatenblatt werden diejenigen Merkmale beschrieben, für die wir eine liefervertragliche Gewährleistung übernehmen. Eine solche Gewährleistung richtet sich ausschließlich nach Maßgabe der im jeweiligen Liefervertrag enthaltenen Bestimmungen. Garantien jeglicher Art werden für das Produkt und dessen Eigenschaften keinesfalls übernommen.

Sollten Sie von uns Produktinformationen benötigen, die über den Inhalt dieses Produktdatenblatts hinausgehen und insbesondere eine spezifische Verwendung und den Einsatz dieses Produktes betreffen, setzen Sie sich bitte mit dem für Sie zuständigen Vertriebsbüro in Verbindung (siehe www.eupec.com, Vertrieb&Kontakt). Für Interessenten halten wir Application Notes bereit.

Aufgrund der technischen Anforderungen könnte unser Produkt gesundheitsgefährdende Substanzen enthalten. Bei Rückfragen zu den in diesem Produkt jeweils enthaltenen Substanzen setzen Sie sich bitte ebenfalls mit dem für Sie zuständigen Vertriebsbüro in Verbindung.

Sollten Sie beabsichtigen, das Produkt in Anwendungen der Luftfahrt, in gesundheits- oder lebensgefährdenden oder lebenserhaltenden Anwendungsbereichen einzusetzen, bitten wir um Mitteilung. Wir weisen darauf hin, dass wir für diese Fälle

- die gemeinsame Durchführung eines Risiko- und Qualitätsassessments;
- den Abschluss von speziellen Qualitätssicherungsvereinbarungen;
- die gemeinsame Einführung von Maßnahmen zu einer laufenden Produktbeobachtung dringend empfehlen und gegebenenfalls die Belieferung von der Umsetzung solcher Maßnahmen abhängig machen.

Soweit erforderlich, bitten wir Sie, entsprechende Hinweise an Ihre Kunden zu geben.

Inhaltliche Änderungen dieses Produktdatenblatts bleiben vorbehalten.

Terms & Conditions of usage

The data contained in this product data sheet is exclusively intended for technically trained staff. You and your technical departments will have to evaluate the suitability of the product for the intended application and the completeness of the product data with respect to such application.

This product data sheet is describing the characteristics of this product for which a warranty is granted. Any such warranty is granted exclusively pursuant the terms and conditions of the supply agreement. There will be no guarantee of any kind for the product and its characteristics.

Should you require product information in excess of the data given in this product data sheet or which concerns the specific application of our product, please contact the sales office, which is responsible for you (see www.eupec.com, sales&contact). For those that are specifically interested we may provide application notes.

Due to technical requirements our product may contain dangerous substances. For information on the types in question please contact the sales office, which is responsible for you.

Should you intend to use the Product in aviation applications, in health or life endangering or life support applications, please notify.

Please note, that for any such applications we urgently recommend

- to perform joint Risk and Quality Assessments;
- the conclusion of Quality Agreements;
- to establish joint measures of an ongoing product survey, and that we may make delivery depended on the realization of any such measures.

If and to the extent necessary, please forward equivalent notices to your customers.

Changes of this product data sheet are reserved.