



Chipsmall Limited consists of a professional team with an average of over 10 year of expertise in the distribution of electronic components. Based in Hongkong, we have already established firm and mutual-benefit business relationships with customers from,Europe,America and south Asia,supplying obsolete and hard-to-find components to meet their specific needs.

With the principle of “Quality Parts,Customers Priority,Honest Operation,and Considerate Service”,our business mainly focus on the distribution of electronic components. Line cards we deal with include Microchip,ALPS,ROHM,Xilinx,Pulse,ON,Everlight and Freescale. Main products comprise IC,Modules,Potentiometer,IC Socket,Relay,Connector.Our parts cover such applications as commercial,industrial, and automotives areas.

We are looking forward to setting up business relationship with you and hope to provide you with the best service and solution. Let us make a better world for our industry!



Contact us

Tel: +86-755-8981 8866 Fax: +86-755-8427 6832

Email & Skype: info@chipsmall.com Web: www.chipsmall.com

Address: A1208, Overseas Decoration Building, #122 Zhenhua RD., Futian, Shenzhen, China



◆ RECOMMENDED PCB LAYOUT (MOUNTING SURFACE SIDE)

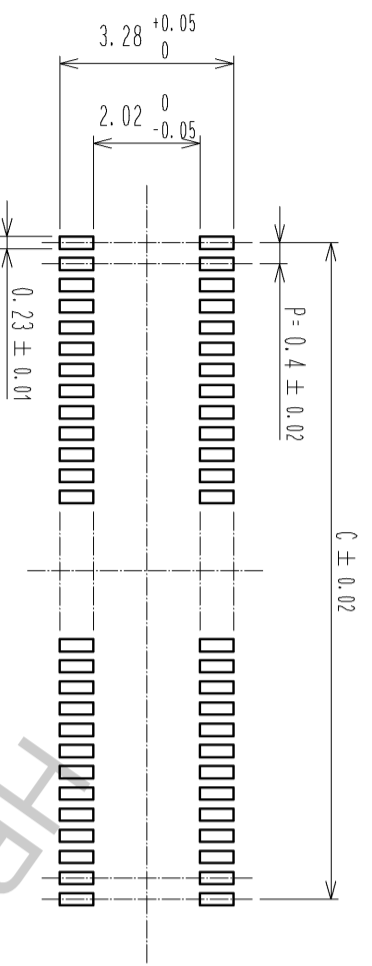

◆ RECOMMENDED METAL MASK DIMENSIONS
METAL MASK THICKNESS : 0.12mm

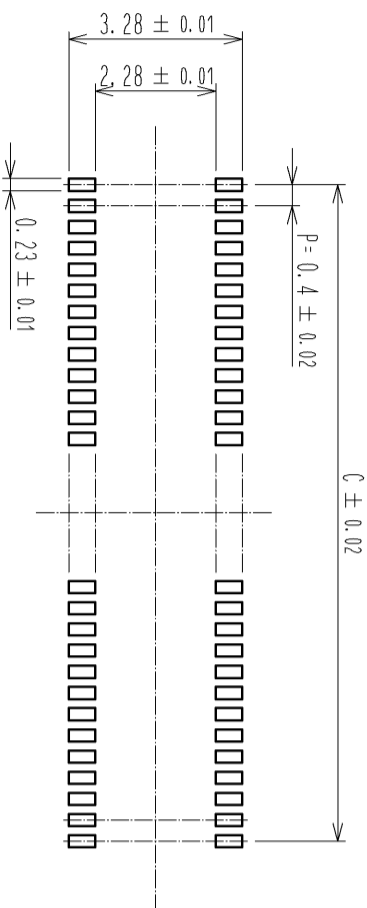

◆ RECOMMENDED METAL MASK DIMENSIONS
METAL MASK THICKNESS : 0.1mm

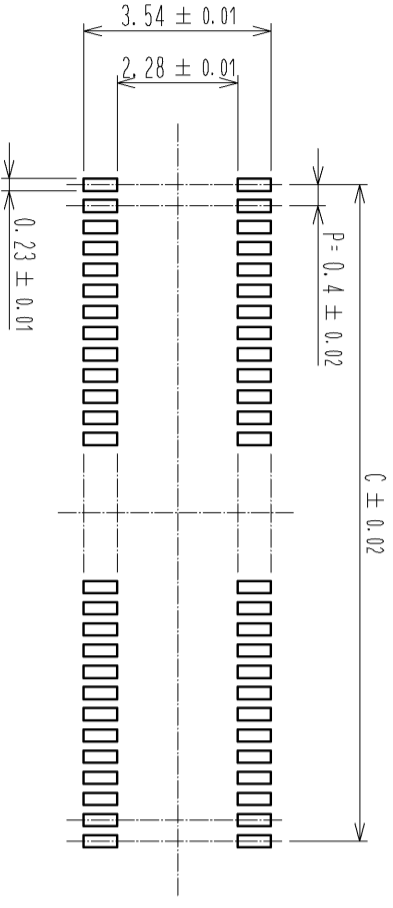

3) RECOMMENDED REFLOW TEMPERATURE PROFILE USING LEAD-FREE SOLDER PASTE.

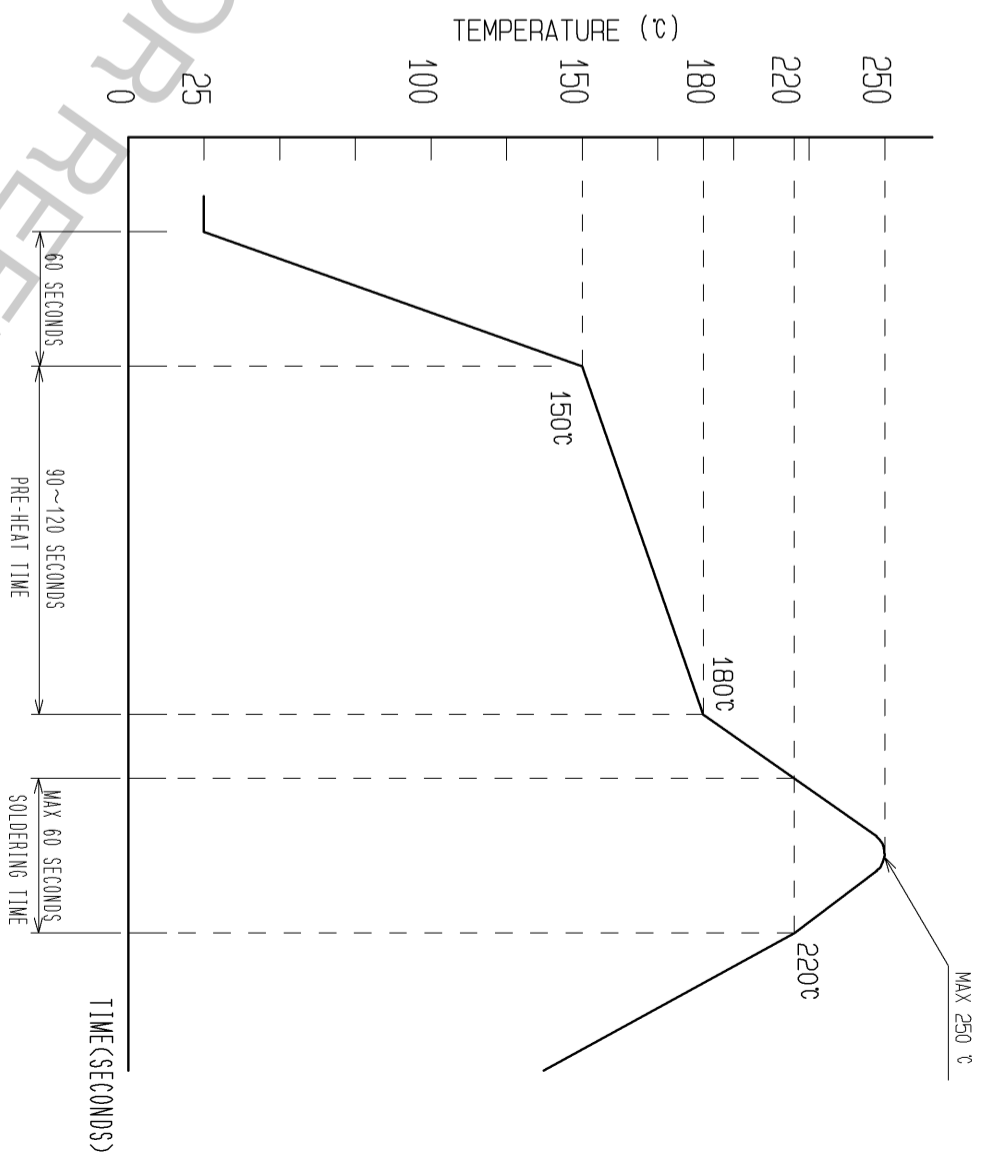

- 1) REFLOW TIME
REFLOW METHOD: IR REFLOW
NUMBER OF REFLOW CYCLES: 2 CYCLES MAX.
DURATION ABOVE 220 °C, 60 SEC. MAX.
(PEAK TEMPERATURE: 250°C MAX.)
- 2) PRE-HEAT TIME
PRE-HEAT TEMPERATURE(MIN) :150 °C
PRE-HEAT TEMPERATURE(MAX) :180 °C
PRE-HEAT TIME : 90~120 sec.

PART NO.	C
DF37NC-100S-0.4V(S1)	1.6
DF37NC-160S-0.4V(S1)	2.8
DF37NC-200S-0.4V(S1)	3.6
DF37NC-240S-0.4V(S1)	4.4
DF37NC-300S-0.4V(S1)	5.6
DF37NC-340S-0.4V(S1)	6.4
DF37NC-400S-0.4V(S1)	7.6
DF37NC-440S-0.4V(S1)	8.4
DF37NC-500S-0.4V(S1)	9.6
DF37NC-600S-0.4V(S1)	11.6
DF37NC-700S-0.4V(S1)	13.6
DF37NC-740S-0.4V(S1)	14.4

3) THIS TEMPERATURE PROFILE IS PER THE CONDITIONS SHOWN ABOVE.
ADDITIONAL FACTORS, SUCH AS SOLDER PASTE TYPE, PCB SIZE AND
OTHER MOUNTED COMPONENTS COULD AFFECT THE PROFILE, THEREFORE,
A THOROUGH EVALUATION OF MOUNTING CONDITION IS REQUIRED
PRIOR TO PRODUCTION. TEMPERATURE IS MEASURED AT CONTACT LEAD.

HRS

DRAWING NO.	EDC3-319684-01
PART NO.	DF37NC-*DS-0.4V(S1)
CODE	
NO.	

EMBOSSED CARRIER TAPE PACKAGING (FREE SIZE)

◆MORE THAN 20 POS.

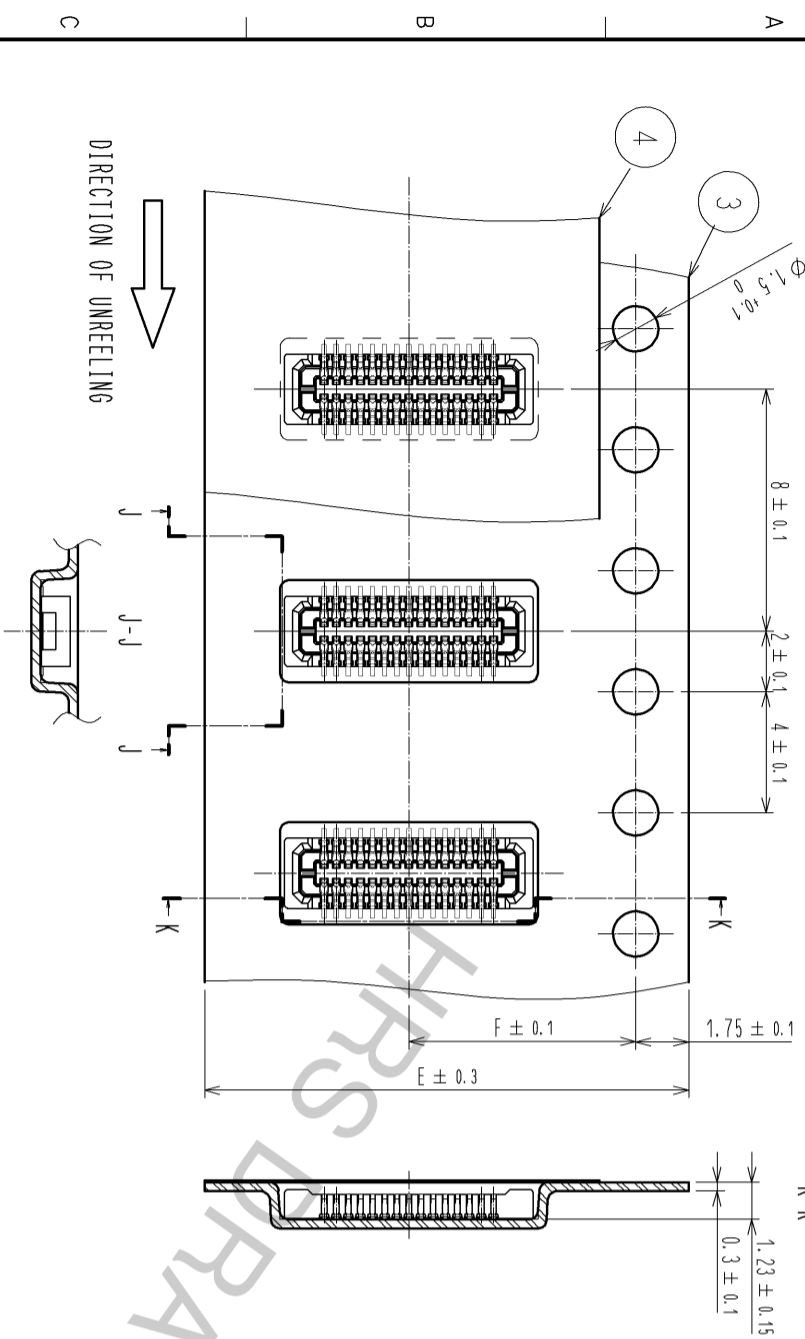

EMBOSSED CARRIER TAPE PACKAGING (FREE SIZE)

◆LESS THAN 20 POS.

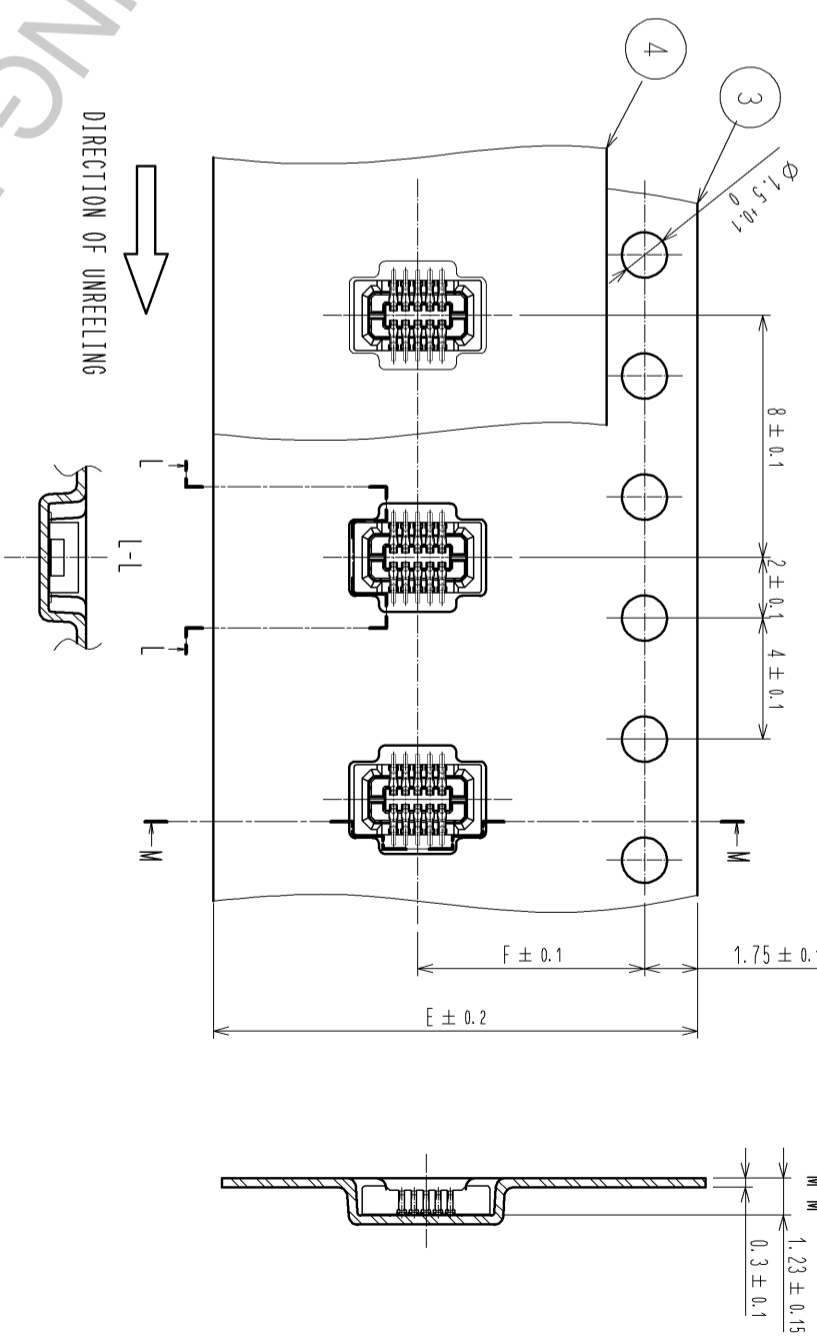

STYLE AND DIMENSION OF REEL (FREE SIZE)

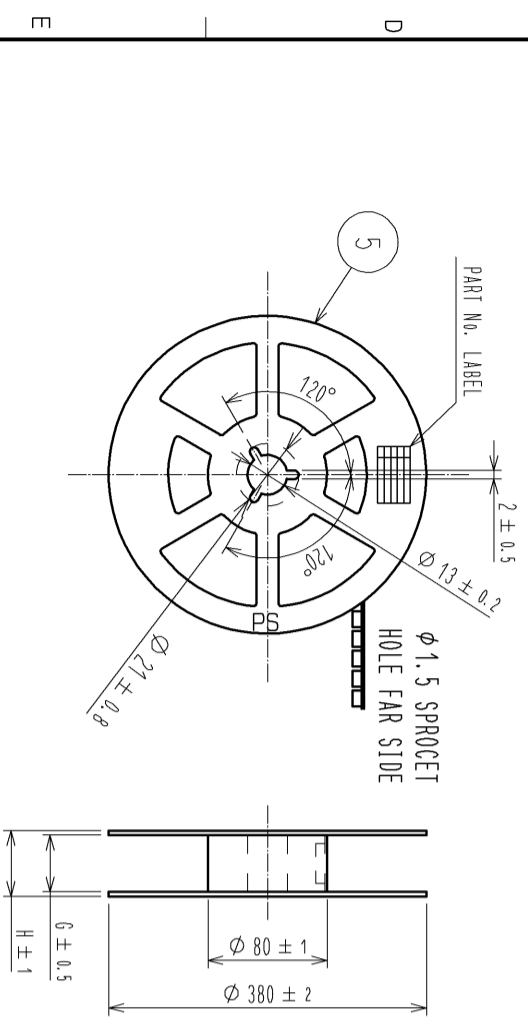

DETAIL OF PART NO. LABEL

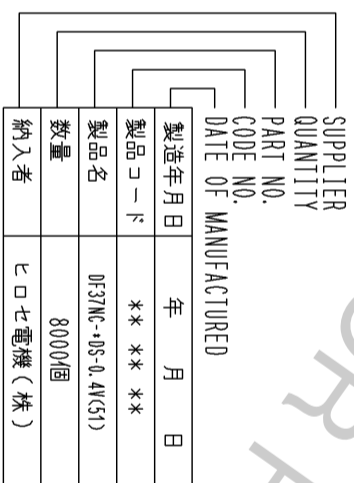

PART No.	E	F	G	H
DF37NC-10DS-0.4V(S1)	16	7.5	17.5	21.5
DF37NC-16DS-0.4V(S1)	16	7.5	17.5	21.5
DF37NC-20DS-0.4V(S1)	16	7.5	17.5	21.5
DF37NC-24DS-0.4V(S1)	16	7.5	17.5	21.5
DF37NC-30DS-0.4V(S1)	24	11.5	25.5	29.5
DF37NC-34DS-0.4V(S1)	24	11.5	25.5	29.5
DF37NC-40DS-0.4V(S1)	24	11.5	25.5	29.5
DF37NC-44DS-0.4V(S1)	24	11.5	25.5	29.5
DF37NC-50DS-0.4V(S1)	24	11.5	25.5	29.5
DF37NC-60DS-0.4V(S1)	24	11.5	25.5	29.5
DF37NC-70DS-0.4V(S1)	32	14.2	33.5	37.5
DF37NC-74DS-0.4V(S1)	32	14.2	33.5	37.5

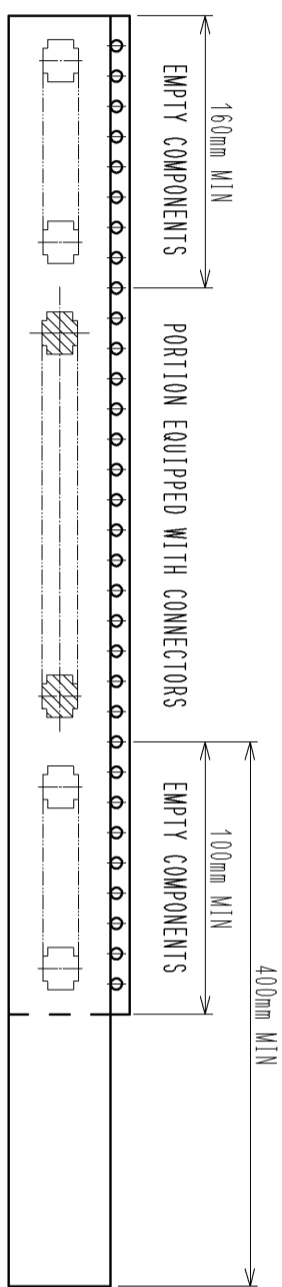

NOTES 4. PER REEL 8000 CONNECTORS.
 5. THE DIMENSIONS IN PARENTHESES ARE FOR REFERENCE.
 6 REFER TO JIS C 0806(PACKING OF COMPONENTS FOR AUTOMATIC HANDLING)
 7 DETAIL OF PART NO. LABEL IS WRITTEN IN JAPANESE.

HRS

DRAWING NO.	EDC3-319684-01
PART NO.	DF37NC-*DS-0.4V(S1)
CODE NO.	