



Chipsmall Limited consists of a professional team with an average of over 10 year of expertise in the distribution of electronic components. Based in Hongkong, we have already established firm and mutual-benefit business relationships with customers from,Europe,America and south Asia,supplying obsolete and hard-to-find components to meet their specific needs.

With the principle of “Quality Parts,Customers Priority,Honest Operation,and Considerate Service”,our business mainly focus on the distribution of electronic components. Line cards we deal with include Microchip,ALPS,ROHM,Xilinx,Pulse,ON,Everlight and Freescale. Main products comprise IC,Modules,Potentiometer,IC Socket,Relay,Connector.Our parts cover such applications as commercial,industrial, and automotives areas.

We are looking forward to setting up business relationship with you and hope to provide you with the best service and solution. Let us make a better world for our industry!



Contact us

Tel: +86-755-8981 8866 Fax: +86-755-8427 6832

Email & Skype: info@chipsmall.com Web: www.chipsmall.com

Address: A1208, Overseas Decoration Building, #122 Zhenhua RD., Futian, Shenzhen, China



Magnetically Compensated Choke, 1-phase, flat design



Approvals and Compliances

Description

- Current compensated choke
- 1-phase choke
- THT-terminals
- Inductor horizontally positioned in housing
- SMD version on request

Applications

- Attenuation of common mode interferences
- Designed for 230/400 VAC applications
- Chopper amplifiers
- DC drives and stepper motor controls
- Switching power supplies

Weblinks

[pdf datasheet](#), [html-datasheet](#), [General Product Information](#), [Distributor-Stock-Check](#), [Detailed request for product](#), [SPICE Library](#)

Technical Data

Rated voltage	up to 440 VAC
Rated Current	0.4 - 6.3A @ Ta 40 °C
Rated inductance	0.6 - 40mH, Tol. -30% +50%
Power Operating Frequency	50 - 400Hz
Terminal Type	THT
Weight	5 - 16g
Material: Housing	UL 94V-0
Sealing Compound	UL 94V-0

Test Voltage	1.8kV, 50Hz, 1 min, winding to winding
Isolation Voltage	2 kV eff., winding to ambient
Climatic Category	25/100/21 acc. to IEC 60068-1
Allowable Operation Temp.	-25 °C to 100 °C

Approvals and Compliances

Detailed information on product approvals, code requirements, usage instructions and detailed test conditions can be looked up in [Details about Approvals](#)

Approvals

The approval mark is used by the testing authorities to certify compliance with the safety requirements placed on electronic products.

Approval Reference Type: DFKF2

Approval Logo	Certificates	Certification Body	Description
	UL Approvals	UL	UL File Number:





Application standards

Application standards where the product can be used

Organization	Design	Standard	Description
	Designed for applications acc.	IEC/UL 60950	IEC 60950-1 includes the basic requirements for the safety of information technology equipment.

Compliances

The product complies with following Guide Lines

Identification	Details	Initiator	Description
	CE declaration of conformity	SCHURTER AG	The CE marking declares that the product complies with the applicable requirements laid down in the harmonisation of Community legislation on its affixing in accordance with EU Regulation 765/2008.
	RoHS	SCHURTER AG	EU Directive RoHS 2011/65/EU
	China RoHS	SCHURTER AG	The law SJ / T 11363-2006 (China RoHS) has been in force since 1 March 2007. It is similar to the EU directive RoHS.
	REACH	SCHURTER AG	On 1 June 2007, Regulation (EC) No 1907/2006 on the Registration, Evaluation, Authorization and Restriction of Chemicals 1 (abbreviated as "REACH") entered into force.

Dimension [mm]

Case 04-2

Case 15-2

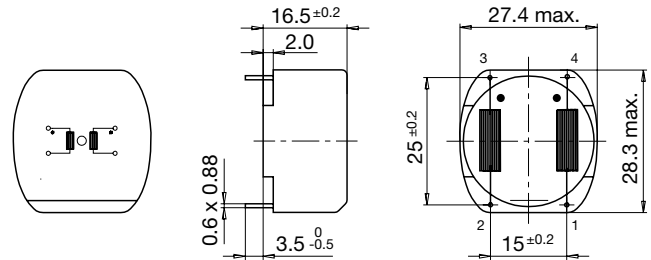
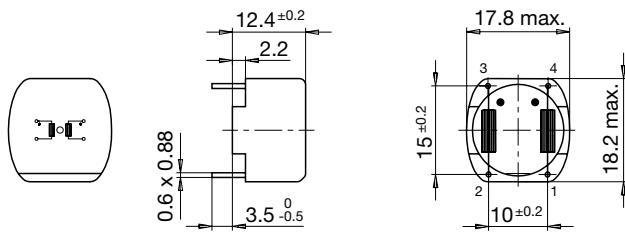

Diagrams

RFI suppression of switching power supply

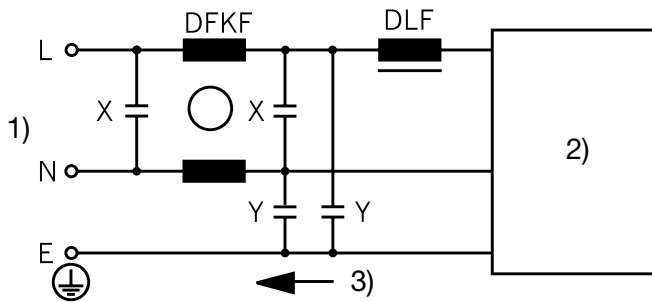

- 1) Power line
- 2) Switching Power Supply
- 3) Interference current

Noise suppression filter

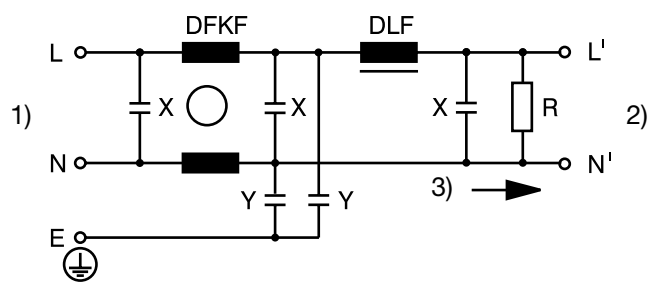

- 1) Power line
- 2) Equipment
- 3) Interference current

Impedance curves

DFKF-18-xxxx

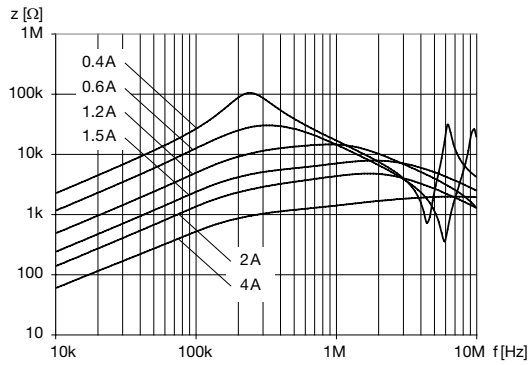

DFKF-28-xxxx

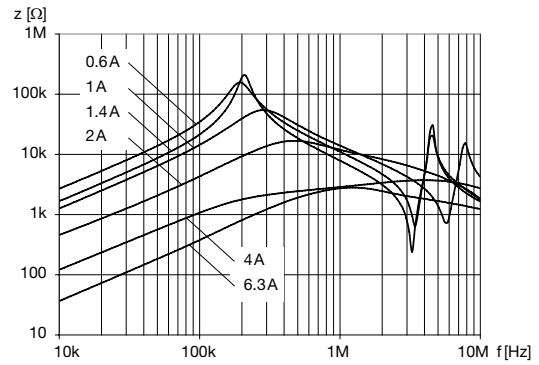

All Variants

I_n [A]	L_n [mH]	R_{cu} [mΩ]	Power _{loss} [W]	f_{RES} [MHz]	Weight [g]	Housings	Packing unit [pcs.]	Order Number
0.4	40	1200	0.4	0.11	5g	04-2	48	DFKF-18-0001
0.6	40	1000	0.7	0.2	16g	15-2	40	DFKF-28-0001
1	20	360	0.7	0.28	16g	15-2	40	DFKF-28-0002
1.2	6.8	200	0.6	0.45	5g	04-2	45	DFKF-18-0003
1.4	27	310	-	-	16g	15-2	40	DFKF-28-0003
1.5	3.3	110	0.5	1.2	5g	04-2	45	DFKF-18-0004
2	1.8	60	-	-	5g	04-2	45	DFKF-18-0005
2	6	100	0.8	0.3	16g	15-2	40	DFKF-28-0004
4	0.7	16	0.5	2.5	5g	04-2	45	DFKF-18-0006
4	1.5	28	0.9	1.3	16g	15-2	40	DFKF-28-0005
6.3	0.6	13	1	2.5	16g	15-2	40	DFKF-28-0006

Most Popular.

Availability for all products can be searched real-time: <https://www.schurter.com/en/Stock-Check/Stock-Check-SCHURTER>