



Chipsmall Limited consists of a professional team with an average of over 10 year of expertise in the distribution of electronic components. Based in Hongkong, we have already established firm and mutual-benefit business relationships with customers from,Europe,America and south Asia,supplying obsolete and hard-to-find components to meet their specific needs.

With the principle of “Quality Parts,Customers Priority,Honest Operation,and Considerate Service”,our business mainly focus on the distribution of electronic components. Line cards we deal with include Microchip,ALPS,ROHM,Xilinx,Pulse,ON,Everlight and Freescale. Main products comprise IC,Modules,Potentiometer,IC Socket,Relay,Connector.Our parts cover such applications as commercial,industrial, and automotives areas.

We are looking forward to setting up business relationship with you and hope to provide you with the best service and solution. Let us make a better world for our industry!



## Contact us

Tel: +86-755-8981 8866 Fax: +86-755-8427 6832

Email & Skype: info@chipsmall.com Web: www.chipsmall.com

Address: A1208, Overseas Decoration Building, #122 Zhenhua RD., Futian, Shenzhen, China



## Description

The DGD2190 is a high voltage/high speed gate driver capable of driving N-Channel MOSFETs and IGBTs in a half bridge configuration. High voltage processing techniques enable the DGD2190's high-side to switch to 600V in a bootstrap operation under high dV/dt conditions.

The DGD2190 logic inputs are compatible with standard TTL and CMOS levels (down to 3.3V) for easy interfacing with controlling devices. The driver outputs feature high pulse current buffers designed for minimum driver cross conduction.

The DGD2190 is offered in the SO-8 (Type TH) package and operates over an extended -40°C to +125°C temperature range.

## Applications

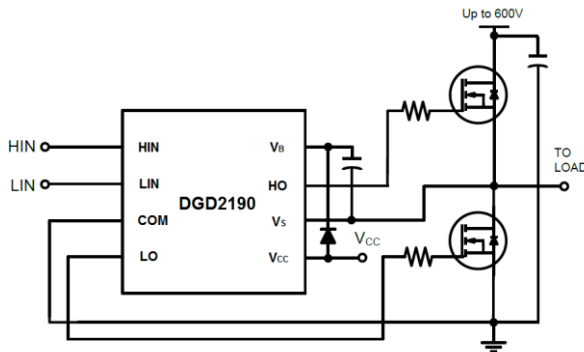
- DC-DC Converters
- DC-AC Inverters
- AC-DC Power Supplies
- Motor Controls
- Class D Power Amplifiers

## Features

- Floating High-Side Driver in Bootstrap Operation to 600V
- Drives Two N-Channel MOSFETs or IGBTs in a Half-Bridge Configuration
- Output Drivers Capable of 4.5A/4.5A Typ Sink/Source
- Logic Input (HIN and LIN) 3.3V Capability
- Schmitt Triggered Logic Inputs with Internal Pull-Down
- Undervoltage Lockout for High and Low-Side Drivers
- Extended Temperature Range: -40°C to +125°C
- **Totally Lead-Free & Fully RoHS Compliant (Notes 1 & 2)**
- **Halogen and Antimony Free. "Green" Device (Note 3)**

## Mechanical Data

- Case: SO-8 (Type TH)
- Case Material: Molded Plastic. "Green" Molding Compound. UL Flammability Classification Rating 94V-0
- Moisture Sensitivity: Level 3 per J-STD-020
- Terminals: Finish – Matte Tin Plated Leads, Solderable per MIL-STD-202, Method 208
- Weight: 0.075 grams (Approximate)



Typical Configuration



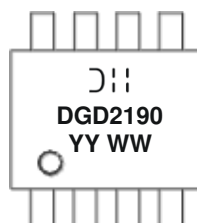
SO-8 (Type TH)  
Top View

## Ordering Information (Note 4)

Product	Marking	Reel Size (inches)	Tape Width (mm)	Quantity Per Reel
DGD2190S8-13	DGD2190	13	12	2,500

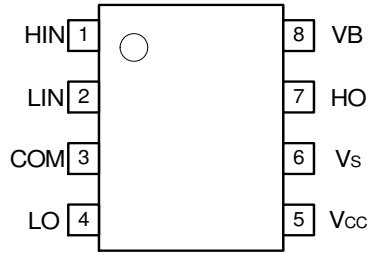
- Notes:
1. No purposely added lead. Fully EU Directive 2002/95/EC (RoHS) & 2011/65/EU (RoHS 2) compliant.
  2. See [http://www.diodes.com/quality/lead\\_free.html](http://www.diodes.com/quality/lead_free.html) for more information about Diodes Incorporated's definitions of Halogen- and Antimony-free, "Green" and Lead-free.
  3. Halogen- and Antimony-free "Green" products are defined as those which contain <900ppm bromine, <900ppm chlorine (<1500ppm total Br + Cl) and <1000ppm antimony compounds.
  4. For packaging details, go to our website at <http://www.diodes.com/products/packages.html>.

## Marking Information



= Manufacturer's marking  
 DGD2190 = Product Type Marking Code  
 YY = Year (ex: 16 = 2016)  
 WW = Week (01 to 53)

**Pin Diagrams**

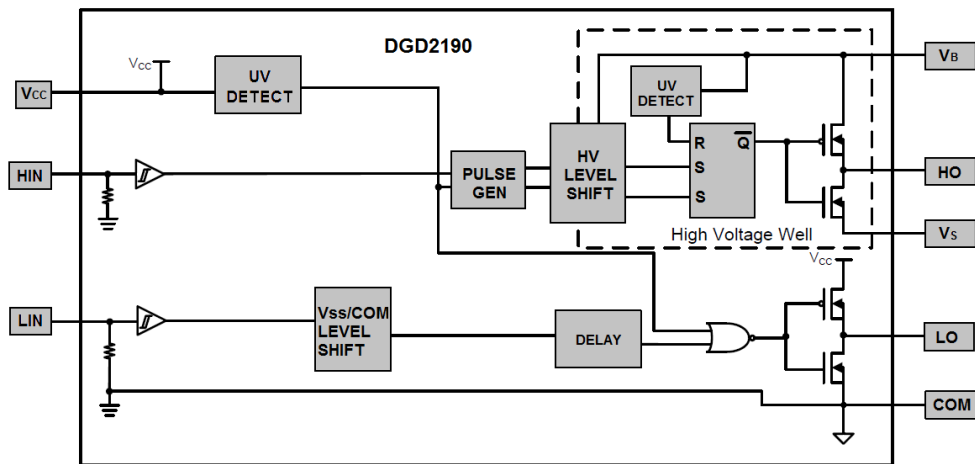


Top View: SO-8 (Type TH)

**Pin Descriptions**

Pin Number	Pin Name	Function
1	HIN	Logic Input for High-side Gate Driver Output, in Phase with HO
2	LIN	Logic Input for Low-side Gate Driver Output, in Phase with LO
3	COM	Low-Side and Logic Return
4	LO	Low-Side Gate Drive Output
5	VCC	Low-Side and Logic Fixed Supply
6	VS	High-Side Floating Supply Return
7	HO	High-Side Gate Drive Output
8	VB	High-Side Floating Supply

**Functional Block Diagram**



**Absolute Maximum Ratings** (@T<sub>A</sub> = +25°C, unless otherwise specified.)

Characteristic	Symbol	Value	Unit
High-side Floating Supply Voltage	V <sub>B</sub>	-0.3 to +624	V
High-side Floating Supply Offset Voltage	V <sub>S</sub>	V <sub>B</sub> -24 to V <sub>B</sub> +0.3	V
High-side Floating Output Voltage	V <sub>HO</sub>	V <sub>S</sub> -0.3 to V <sub>B</sub> +0.3	V
Offset Supply Voltage Transient	dV <sub>S</sub> / dt	50	V/ns
Low-side and Logic Fixed Supply Voltage	V <sub>CC</sub>	-0.3 to +24	V
Low-side Output Voltage	V <sub>LO</sub>	-0.3 to V <sub>CC</sub> +0.3	V
Logic Input Voltage (HIN and LIN)	V <sub>IN</sub>	-0.3 to V <sub>CC</sub> +0.3	V

**Thermal Characteristics** (@T<sub>A</sub> = +25°C, unless otherwise specified.)

Characteristic	Symbol	Value	Unit
Power Dissipation Linear Derating Factor (Note 5)	P <sub>D</sub>	0.625	W
Thermal Resistance, Junction to Ambient (Note 5)	R <sub>θJA</sub>	200	°C/W
Thermal Resistance, Junction to Case (Note 5)	R <sub>θJC</sub>	45	°C/W
Operating Temperature	T <sub>J</sub>	+150	°C
Storage Temperature Range	T <sub>STG</sub>	-55 to +150	

**Recommended Operating Conditions**

Parameter	Symbol	Min	Max	Unit
High-side Floating Supply Absolute Voltage	V <sub>B</sub>	V <sub>S</sub> +10	V <sub>S</sub> +20	V
High-side Floating Supply Offset Voltage	V <sub>S</sub>	(Note 6)	600	V
High-side Floating Output Voltage	V <sub>HO</sub>	V <sub>S</sub>	V <sub>B</sub>	V
Low-side Fixed Supply Voltage	V <sub>CC</sub>	10	20	V
Low-side Output Voltage	V <sub>LO</sub>	0	V <sub>CC</sub>	V
Logic Input Voltage (HIN and LIN)	V <sub>IN</sub>	0	5	V
Ambient Temperature	T <sub>A</sub>	-40	+125	°C

- Notes:
5. When mounted on a standard JEDEC 2-layer FR-4 board.
  6. Logic operation for V<sub>S</sub> of -5V to +600V. Logic state held for V<sub>S</sub> of -5V to -V<sub>BS</sub>.

**DC Electrical Characteristics** ( $V_{BIAS}$  ( $V_{CC}$ ,  $V_{BS}$ ) = 15V, @ $T_A$  = +25°C, unless otherwise specified.) (Note 7)

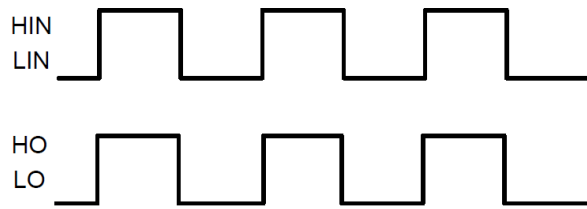
Parameter	Symbol	Min	Typ	Max	Unit	Conditions
Logic "1" Input Voltage	$V_{IH}$	2.5	—	—	V	$V_{CC} = 10V$ to $20V$
Logic "0" Input Voltage	$V_{IL}$	—	—	0.8	V	$V_{CC} = 10V$ to $20V$
High Level Output Voltage, $V_{BIAS} - V_O$	$V_{OH}$	—	—	0.1	V	$I_O = 0mA$
Low Level Output Voltage, $V_O$	$V_{OL}$	—	—	0.035	V	$I_O = 0mA$
Offset Supply Leakage Current	$I_{LK}$	—	—	50	$\mu A$	$V_B = V_S = 600V$
Quiescent $V_{BS}$ Supply Current	$I_{BSQ}$	—	45	80	$\mu A$	$V_{IN} = 0V$ or $5V$
Quiescent $V_{CC}$ Supply Current	$I_{CCQ}$	—	75	200	$\mu A$	$V_{IN} = 0V$ or $5V$
Logic "1" Input Bias Current	$I_{IN+}$	—	25	50	$\mu A$	$V_{IN} = 5V$
Logic "0" Input Bias Current	$I_{IN-}$	—	1.0	2.0	$\mu A$	$V_{IN} = 0V$
$V_{BS}$ Supply Undervoltage Positive Going Threshold	$V_{BSUV+}$	7.6	8.4	9.8	V	—
$V_{BS}$ Supply Undervoltage Negative Going Threshold	$V_{BSUV-}$	6.9	7.8	9.0	V	—
$V_{CC}$ Supply Undervoltage Positive Going Threshold	$V_{CCUV+}$	7.6	8.4	9.8	V	—
$V_{CC}$ Supply Undervoltage Negative Going Threshold	$V_{CCUV-}$	6.9	7.8	9.0	V	—
$V_{CC}$ and $V_{BS}$ Undervoltage Hysteresis	$V_{CCUVH}$	—	0.6	—	V	—
	$V_{BSUVH}$	—	0.6	—	V	—
Output High Short Circuit Pulsed Current	$I_{O+}$	3.5	4.5	—	A	$V_O = 0V$ , $PW \leq 10ms$
Output Low Short Circuit Pulsed Current	$I_{O-}$	3.5	4.5	—	A	$V_O = 15V$ , $PW \leq 10ms$

Note: 7. The  $V_{IN}$  and  $I_{IN}$  parameters are applicable to the two logic pins;  $H_{IN}$  and  $L_{IN}$ . The  $V_O$  and  $I_O$  parameters are applicable to the respective output pins:  $H_O$  and  $L_O$ .

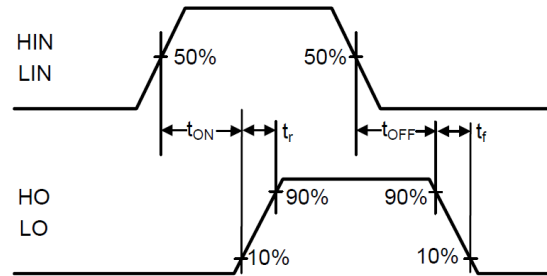
**AC Electrical Characteristics** ( $V_{BIAS}$  ( $V_{CC}$ ,  $V_{BS}$ ) = 15V,  $C_L = 1000pF$ , @ $T_A$  = +25°C, unless otherwise specified.)

Parameter	Symbol	Min	Typ	Max	Unit	Conditions
Turn-On Propagation Delay	$t_{ON}$	—	140	200	ns	$V_S = 0V$
Turn-Off Propagation Delay	$t_{OFF}$	—	140	200	ns	$V_S = 0V$
Delay Matching, $H_O$ & $L_O$ Turn On/Off	$t_{DM}$	—	0	50	ns	—
Turn-On Rise Time	$t_R$	—	25	50	ns	$V_S = 0V$
Turn-Off Fall Time	$t_F$	—	20	45	ns	$V_S = 0V$

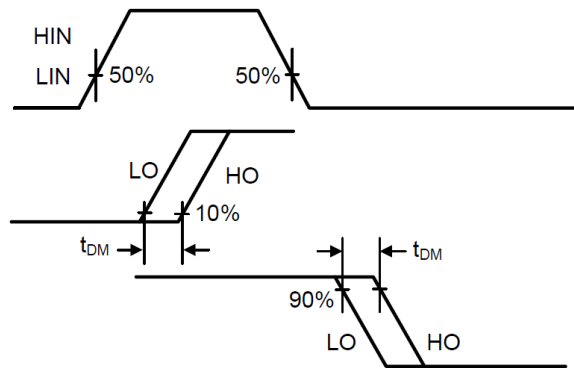
**Timing Waveforms**



**Figure 1.** Input / Output Timing Diagram

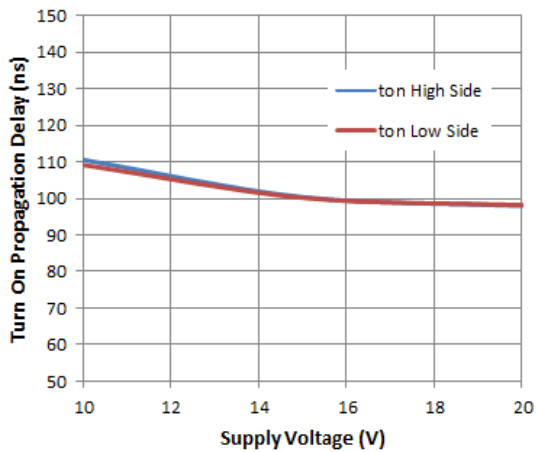


**Figure 2.** Switching Time Waveform Definitions

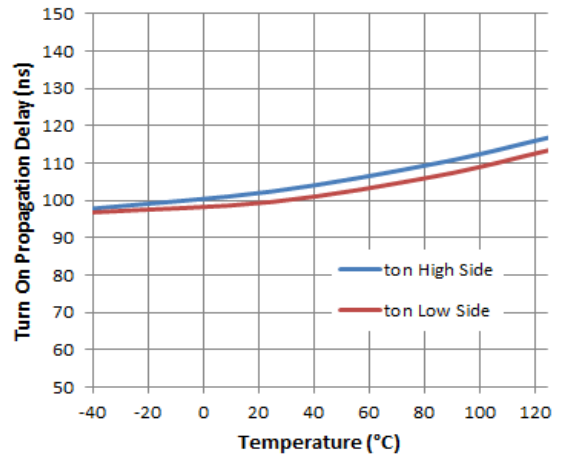


**Figure 3.** Delay Matching Waveform Definitions

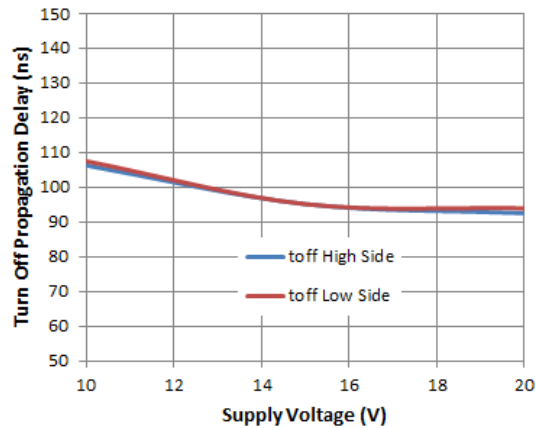
**Typical Performance Characteristics** (@T<sub>A</sub> = +25°C, unless otherwise specified.)



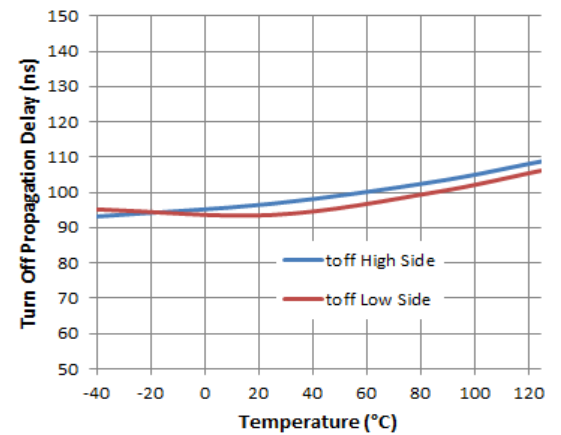
**Figure 4.** Turn-on Propagation Delay vs. Supply Voltage



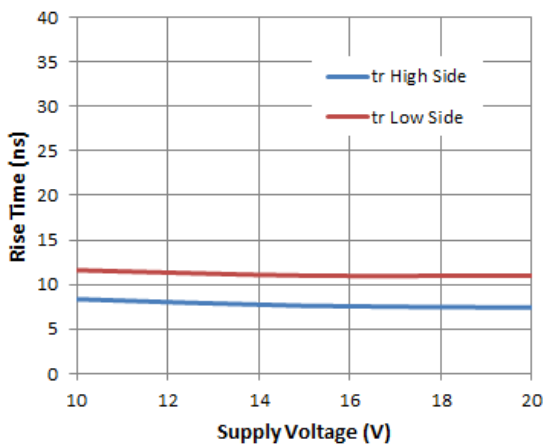
**Figure 5.** Turn-on Propagation Delay vs. Temperature



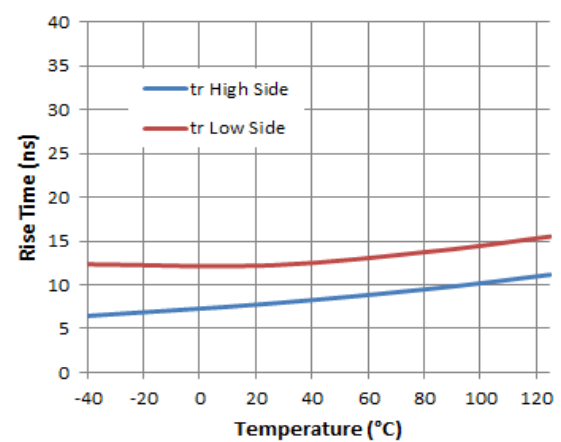
**Figure 6.** Turn-off Propagation Delay vs. Supply Voltage



**Figure 7.** Turn-off Propagation Delay vs. Temperature

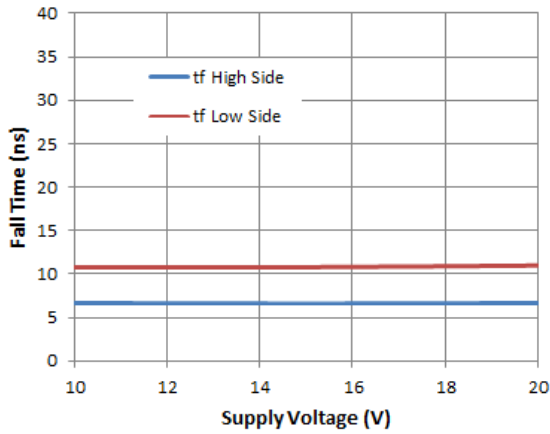


**Figure 8.** Rise Time vs. Supply Voltage

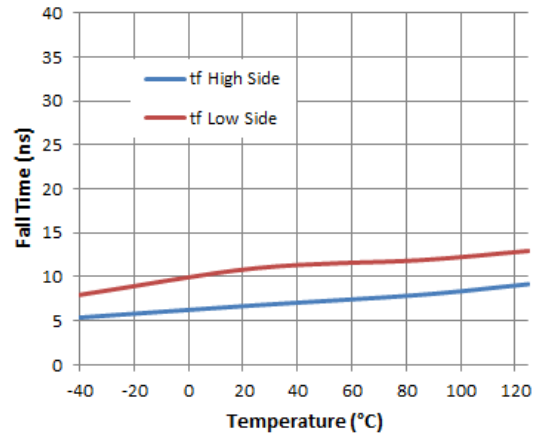


**Figure 9.** Rise Time vs. Temperature

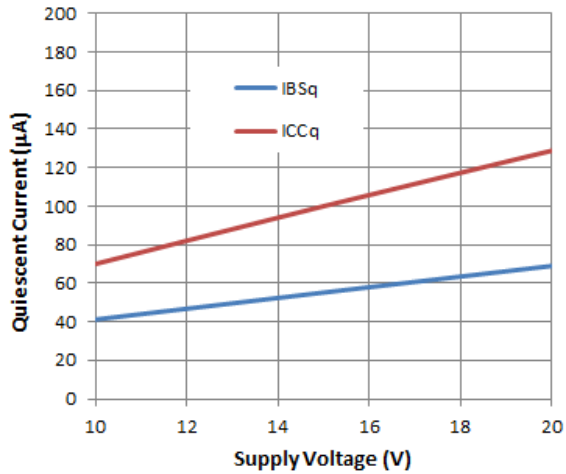
**Typical Performance Characteristics** (Cont.) (@T<sub>A</sub> = +25°C, unless otherwise specified.)



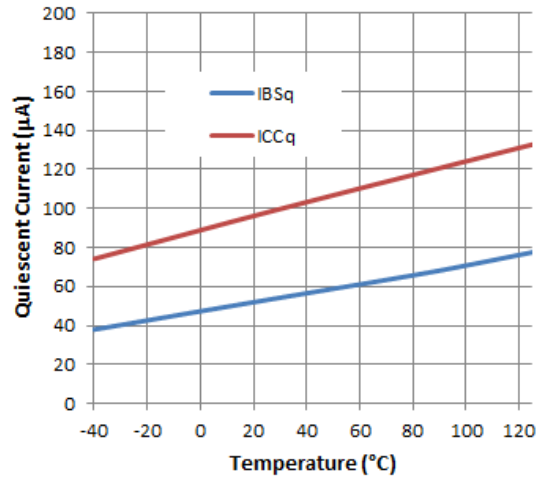
**Figure 10.** Fall Time vs. Supply Voltage



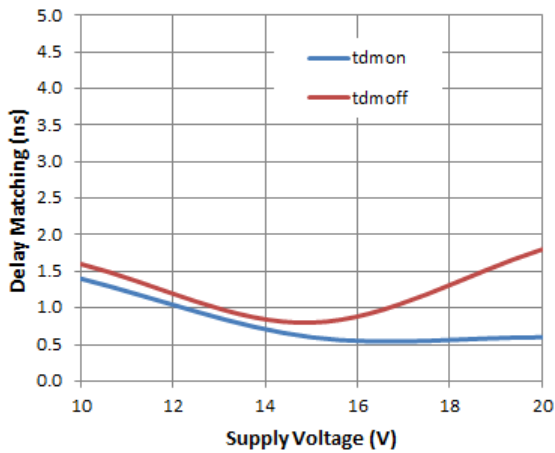
**Figure 11.** Fall Time vs. Temperature



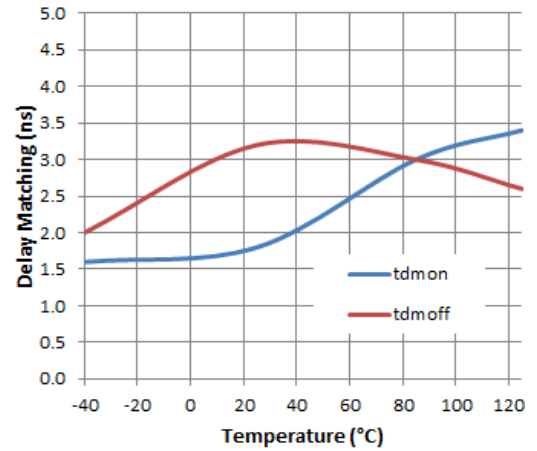
**Figure 12.** Quiescent Current vs. Supply Voltage



**Figure 13.** Quiescent Current vs. Temperature



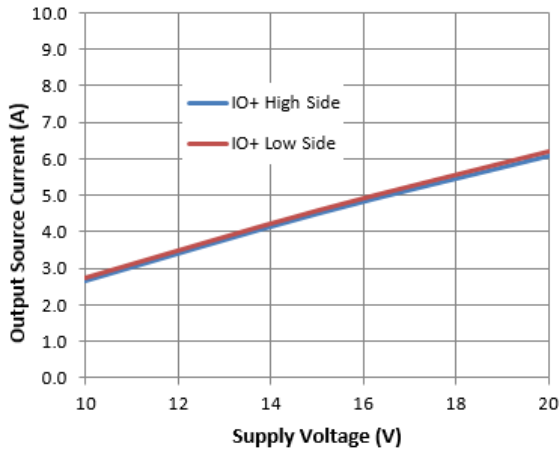
**Figure 14.** Delay Matching vs. Supply Voltage



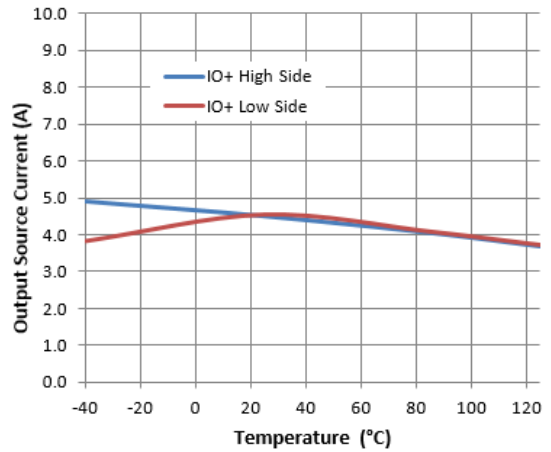
**Figure 15.** Delay Matching vs. Temperature



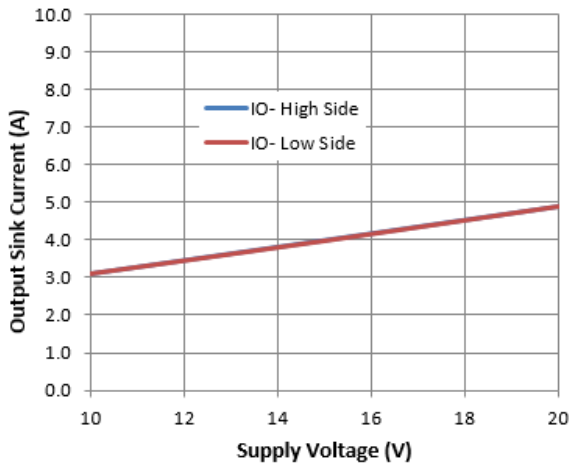
**Typical Performance Characteristics** (Cont.) (@T<sub>A</sub> = +25°C, unless otherwise specified.)



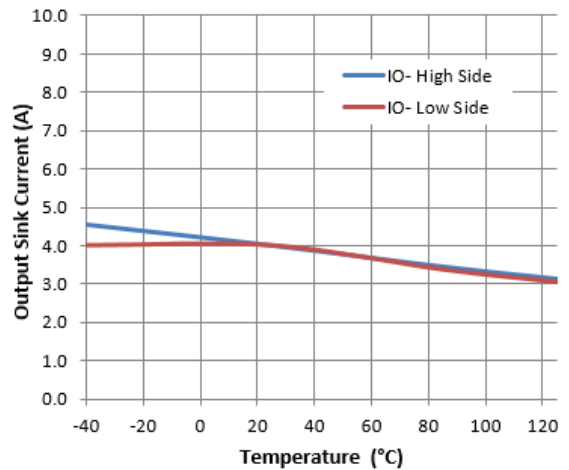
**Figure 16.** Output Source Current vs. Supply Voltage



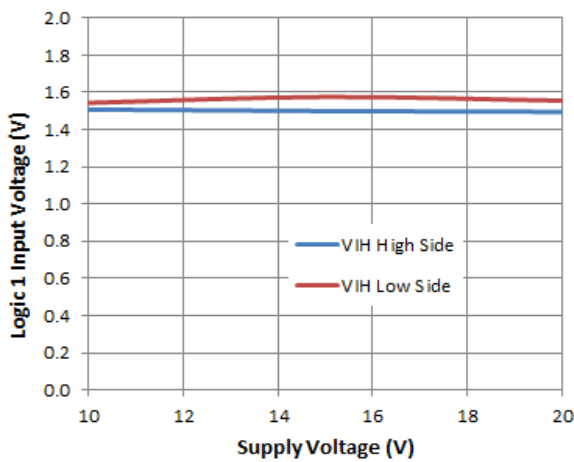
**Figure 17.** Output Source Current vs. Temperature



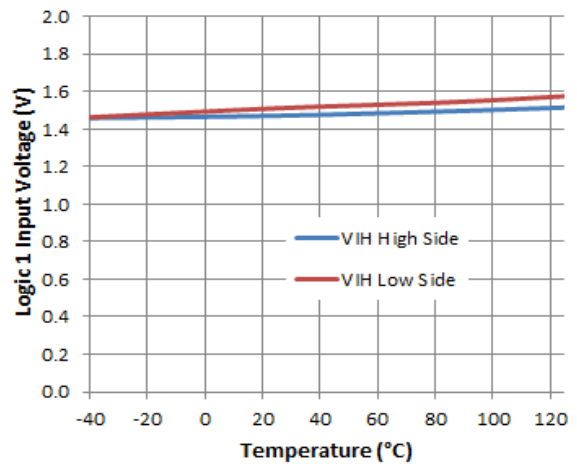
**Figure 18.** Output Sink Current vs. Supply Voltage



**Figure 19.** Output Sink Current vs. Temperature

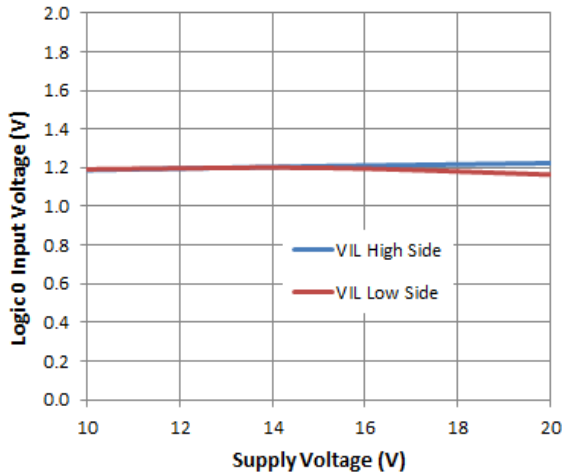


**Figure 20.** Logic 1 Input Voltage vs. Supply Voltage

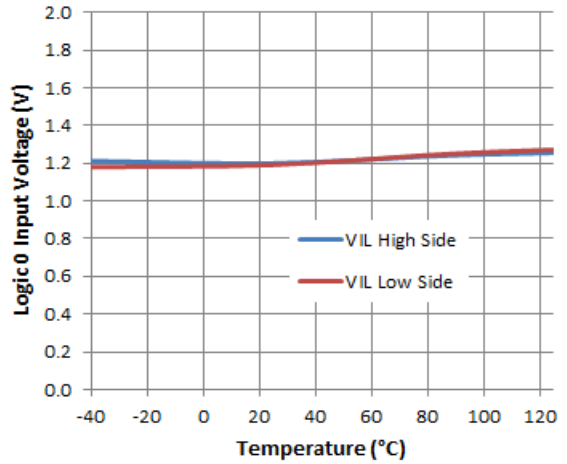


**Figure 21.** Logic 1 Input Voltage vs. Temperature

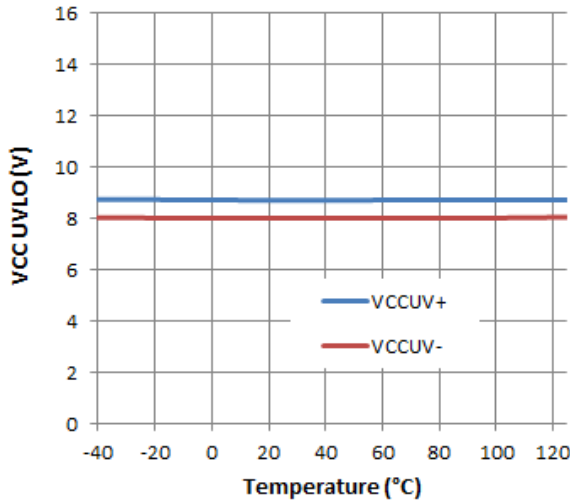
**Typical Performance Characteristics** (Cont.) (@T<sub>A</sub> = +25°C, unless otherwise specified.)



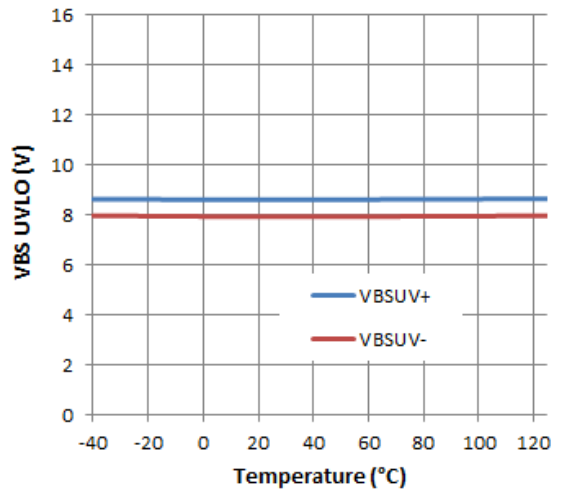
**Figure 22.** Logic 0 Input Voltage vs. Supply Voltage



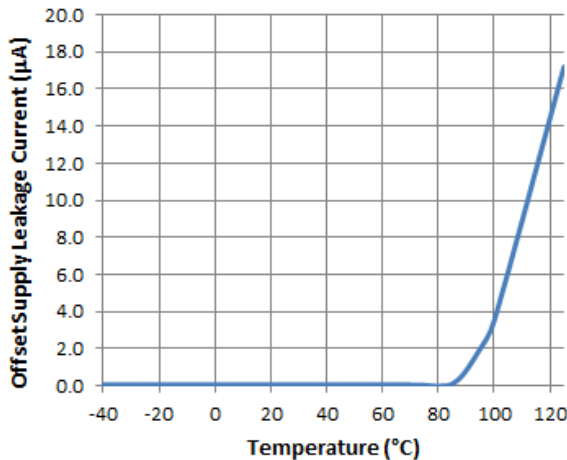
**Figure 23.** Logic 0 Input Voltage vs. Temperature



**Figure 24.** VCC UVLO vs. Temperature



**Figure 25.** VBS UVLO vs. Temperature

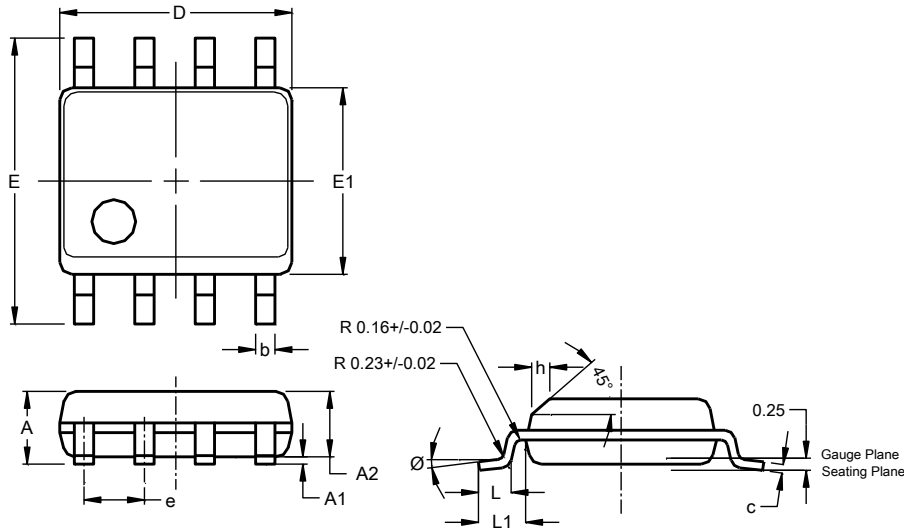


**Figure 26.** Offset Supply Leakage Current vs. Temperature

**Package Outline Dimensions**

Please see <http://www.diodes.com/package-outlines.html> for the latest version.

**SO-8 (Type TH)**

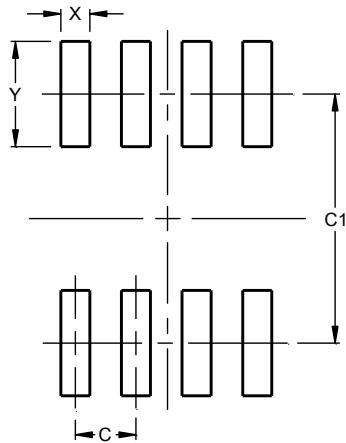


SO-8 (Type TH)			
Dim	Min	Max	Typ
A	1.35	1.75	—
A1	0.10	0.25	—
A2	—	—	1.45
b	0.35	0.51	—
c	0.190	0.248	—
D	4.80	5.00	4.90
E	5.80	6.20	6.00
E1	3.80	4.00	3.90
e	—	—	1.27
h	0.25	0.50	—
L	0.41	1.27	—
L1	—	—	1.04
Ø	0°	8°	—
<b>All Dimensions in mm</b>			

**Suggested Pad Layout**

Please see <http://www.diodes.com/package-outlines.html> for the latest version.

**SO-8 (Type TH)**



Dimensions	Value (in mm)
C	1.27
C1	5.20
X	0.60
Y	2.20

Note: For high voltage applications, the appropriate industry sector guidelines should be considered with regards to creepage and clearance distances between device Terminals and PCB tracking.

**IMPORTANT NOTICE**

DIODES INCORPORATED MAKES NO WARRANTY OF ANY KIND, EXPRESS OR IMPLIED, WITH REGARDS TO THIS DOCUMENT, INCLUDING, BUT NOT LIMITED TO, THE IMPLIED WARRANTIES OF MERCHANTABILITY AND FITNESS FOR A PARTICULAR PURPOSE (AND THEIR EQUIVALENTS UNDER THE LAWS OF ANY JURISDICTION).

Diodes Incorporated and its subsidiaries reserve the right to make modifications, enhancements, improvements, corrections or other changes without further notice to this document and any product described herein. Diodes Incorporated does not assume any liability arising out of the application or use of this document or any product described herein; neither does Diodes Incorporated convey any license under its patent or trademark rights, nor the rights of others. Any Customer or user of this document or products described herein in such applications shall assume all risks of such use and will agree to hold Diodes Incorporated and all the companies whose products are represented on Diodes Incorporated website, harmless against all damages.

Diodes Incorporated does not warrant or accept any liability whatsoever in respect of any products purchased through unauthorized sales channel. Should Customers purchase or use Diodes Incorporated products for any unintended or unauthorized application, Customers shall indemnify and hold Diodes Incorporated and its representatives harmless against all claims, damages, expenses, and attorney fees arising out of, directly or indirectly, any claim of personal injury or death associated with such unintended or unauthorized application.

Products described herein may be covered by one or more United States, international or foreign patents pending. Product names and markings noted herein may also be covered by one or more United States, international or foreign trademarks.

This document is written in English but may be translated into multiple languages for reference. Only the English version of this document is the final and determinative format released by Diodes Incorporated.

**LIFE SUPPORT**

Diodes Incorporated products are specifically not authorized for use as critical components in life support devices or systems without the express written approval of the Chief Executive Officer of Diodes Incorporated. As used herein:

A. Life support devices or systems are devices or systems which:

1. are intended to implant into the body, or
2. support or sustain life and whose failure to perform when properly used in accordance with instructions for use provided in the labeling can be reasonably expected to result in significant injury to the user.

B. A critical component is any component in a life support device or system whose failure to perform can be reasonably expected to cause the failure of the life support device or to affect its safety or effectiveness.

Customers represent that they have all necessary expertise in the safety and regulatory ramifications of their life support devices or systems, and acknowledge and agree that they are solely responsible for all legal, regulatory and safety-related requirements concerning their products and any use of Diodes Incorporated products in such safety-critical, life support devices or systems, notwithstanding any devices- or systems-related information or support that may be provided by Diodes Incorporated. Further, Customers must fully indemnify Diodes Incorporated and its representatives against any damages arising out of the use of Diodes Incorporated products in such safety-critical, life support devices or systems.

Copyright © 2016, Diodes Incorporated

[www.diodes.com](http://www.diodes.com)