



Chipsmall Limited consists of a professional team with an average of over 10 year of expertise in the distribution of electronic components. Based in Hongkong, we have already established firm and mutual-benefit business relationships with customers from,Europe,America and south Asia,supplying obsolete and hard-to-find components to meet their specific needs.

With the principle of “Quality Parts,Customers Priority,Honest Operation,and Considerate Service”,our business mainly focus on the distribution of electronic components. Line cards we deal with include Microchip,ALPS,ROHM,Xilinx,Pulse,ON,Everlight and Freescale. Main products comprise IC,Modules,Potentiometer,IC Socket,Relay,Connector.Our parts cover such applications as commercial,industrial, and automotives areas.

We are looking forward to setting up business relationship with you and hope to provide you with the best service and solution. Let us make a better world for our industry!



Contact us

Tel: +86-755-8981 8866 Fax: +86-755-8427 6832

Email & Skype: info@chipsmall.com Web: www.chipsmall.com

Address: A1208, Overseas Decoration Building, #122 Zhenhua RD., Futian, Shenzhen, China



Monitoring Relays 1-Phase True RMS AC Over or Under Current Type DIB01 100A

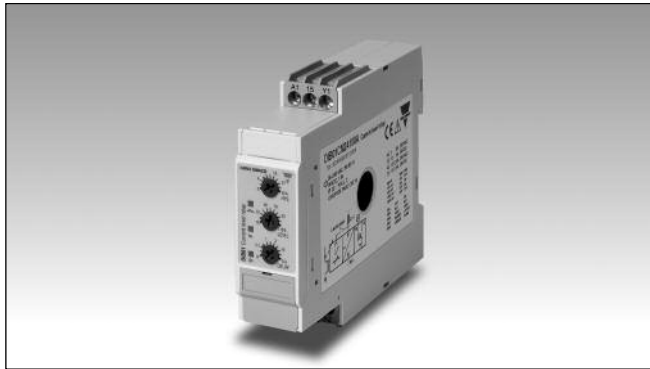

- TRMS AC over or under current monitoring relay
- Current measuring through built-in current transformer
- Selection of measuring range by DIP-switches
- Measuring ranges from 2 A to 100 A AC
- Adjustable current on relative scale
- Adjustable hysteresis on relative scale
- Adjustable delay function (0.1 to 30 s)
- Programmable latching or inhibit at set level
- Output: 8 A SPDT relay N.D. or N.E. selectable
- For mounting on DIN-rail in accordance with DIN/EN 50 022
- 22.5 mm Euronorm housing
- LED indication for relay, alarm and power supply ON
- Galvanically separated power supply

Product Description

DIB01 is a precise TRMS AC over or under current (selectable by DIP-switch) monitoring relay. Owing to the built-in latch function, the ON-position of the relay output can be maintained. Inhibit function can be used to avoid relay

operation when not desired (maintenance, transitions). The LED's indicate the state of the alarm and the output relay. Through the built-in current transformer it is possible to monitor loads up to 100 A AC.

Ordering Key

DIB 01 C M24 100A

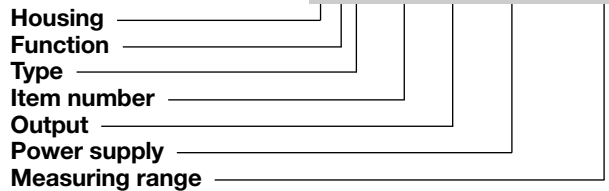

Type Selection

Mounting	Output	Measuring range	Supply: 24 VDC and 24 to 240 VAC
DIN-rail	SPDT	2 to 100 A AC	DIB 01 C M24 100A

Input Specifications

Input (current level)	Built-in current transformer	Contact input	Terminals A1, Y1
DIB01 100A		DIB01 Disabled Enabled Latch disable	Open < 10 kΩ > 500 ms
Measuring ranges Selectable by DIP-switch	Max current		
2 to 20 A AC	120 A		
5 to 50 A AC	120 A		
10 to 100 A AC	120 A		
Max. current for 30 s	250 A		
Max. current for 1 s	2000 A		

Supply Specifications

Power supply Rated operational voltage through terminals: A1, A2	Overvoltage cat. III (IEC 60664, IEC 60038) 24 VDC - 15% +10% 24 to 240 VAC ± 15% 45 to 65 Hz
Dielectric voltage Supply to input Supply to output Input to output	4 kV 4 kV 4 kV
Rated operational power DC AC	1 W 1 W / 35 VA

Output Specifications

Output Rated insulation voltage	SPDT relay 250 VAC
Contact ratings (AgSnO₂) Resistive loads Small inductive loads	μ 8 A @ 250 VAC 5 A @ 24 VDC 2.5 A @ 250 VAC 2.5 A @ 24 VDC
Mechanical life	≥ 30 x 10 ⁶ operations
Electrical life	≥ 10 ⁵ operations (at 8 A, 250 V, cos φ = 1)
Operating frequency	≤ 7200 operations/h
Dielectric strength Dielectric voltage Rated impulse withstand volt.	≥ 2 kVAC (rms) 4 kV (1.2/50 μs)



General Specifications

Power ON delay	1 s ± 0.5 s or 6 s ± 0.5 s	Housing	
Reaction time		Dimensions	22.5 x 80 x 99.5 mm
Alarm ON delay	< 100 ms	Material	PA66 or Noryl
Alarm OFF delay	< 100 ms	Weight	Approx. 155 g
Accuracy	(15 min warm-up time)	Screw terminals	
Temperature drift	± 500 ppm/°C	Tightening torque	Max. 0.5 Nm acc. to IEC 60947
Delay ON alarm	± 10% on set value ± 50 ms	Product standard	EN 60255-6
Repeatability	± 0.5% on full-scale	Approvals	UL, CSA
Indication for		CE Marking	L.V. Directive 2006/95/EC EMC Directive 2004/108/EC
Power supply ON	LED, green	EMC	
Alarm ON	LED, red (flashing 2 Hz during delay time)	Immunity	According to EN 60255-26 According to EN 61000-6-2
Output relay ON	LED, yellow	Emissions	According to EN 60255-26 According to EN 61000-6-3
Environment	(EN 60529)		
Degree of protection	IP 20		
Pollution degree	3		
Operating temperature	-20 to 60°C, R.H. < 95%		
Storage temperature	-30 to 80°C, R.H. < 95%		

Mode of Operation

DIB01 monitors AC over or under current through an internal current transformer.

Example 1

(connection between terminals A1, Y1 - latching function enabled - Relay ND)
The relay operates and latches in operating position when the measured value exceeds (or drops below)

the set level for more than the set delay time. Provided that the current has dropped below (or has exceeded) the set point (see hysteresis setting), the relay releases when the interconnection between terminals A1, Y1 is interrupted or the power supply is interrupted as well. The red LED flashes until the delay time has expired.

Example 2

(no connection between terminals A1, Y1 - latch function disabled - Relay ND)
The relay operates when the measured value exceeds (or drops below) the set level for more than the set delay time. It releases when the current drops below (or exceeds) the set level (see hysteresis setting) or when

power supply is interrupted.

Note

When the inhibit contact is opened, if the input signal is already in alarm position, the delay time needs to elapse before relay activation.

Function/Range/Level and Time Delay Setting

Adjust the input range setting DIP switches 1 and 2 as shown below.

Select the desired function setting DIP switches 3 to 6 as shown below.

To access the DIP switches open the grey plastic cover as shown below.

Selection of level and time delay:

Lower knob:

Setting of delay on alarm time on absolute scale (0.1 to 30 s).

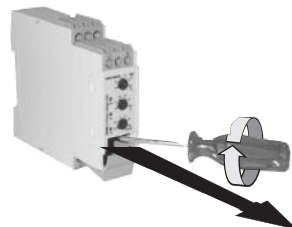

Upper knob:

Setting of hysteresis on relative scale: 0 to 30% on set value.

Centre knob:

Current level setting on relative scale: 10 to 110% on full scale.

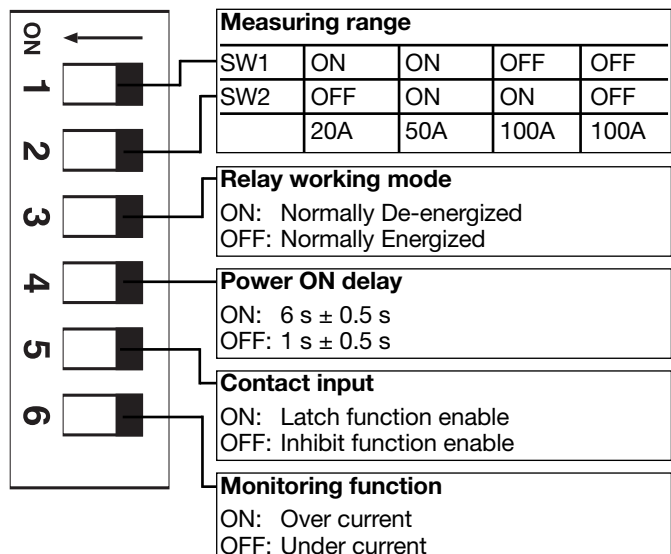

Operation Diagrams

Over current - N.D. relay

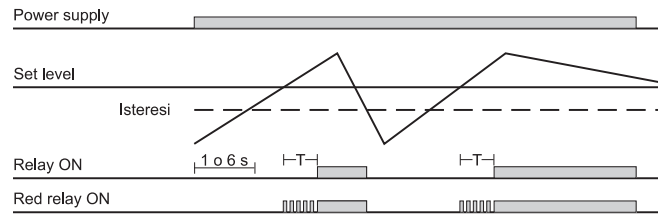

Under current - Latch function - N.D. relay

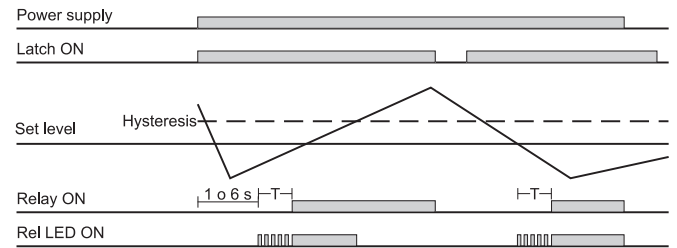

Under current - N.D. relay

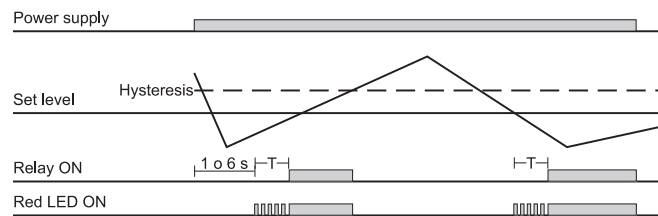

Over current - Inhibit function - N.D. relay

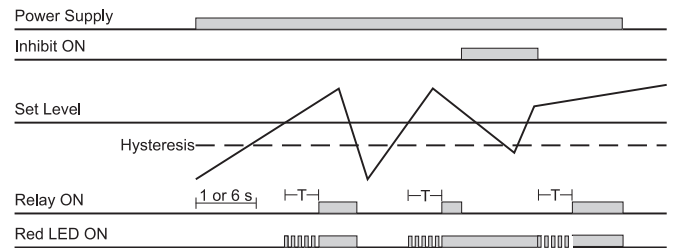

Wiring Diagram

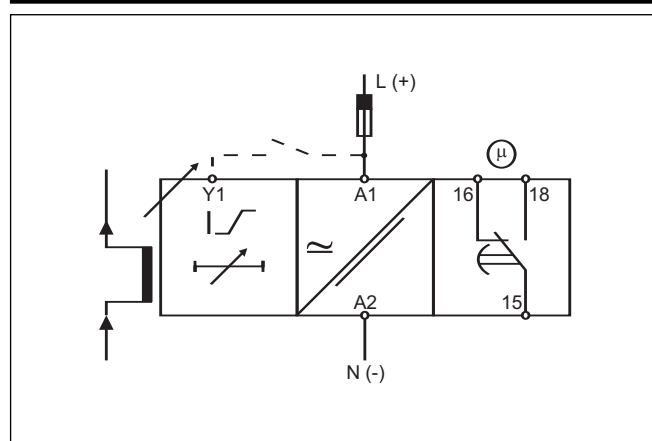

Dimensions

