



Chipsmall Limited consists of a professional team with an average of over 10 year of expertise in the distribution of electronic components. Based in Hongkong, we have already established firm and mutual-benefit business relationships with customers from,Europe,America and south Asia,supplying obsolete and hard-to-find components to meet their specific needs.

With the principle of “Quality Parts,Customers Priority,Honest Operation,and Considerate Service”,our business mainly focus on the distribution of electronic components. Line cards we deal with include Microchip,ALPS,ROHM,Xilinx,Pulse,ON,Everlight and Freescale. Main products comprise IC,Modules,Potentiometer,IC Socket,Relay,Connector.Our parts cover such applications as commercial,industrial, and automotives areas.

We are looking forward to setting up business relationship with you and hope to provide you with the best service and solution. Let us make a better world for our industry!



Contact us

Tel: +86-755-8981 8866 Fax: +86-755-8427 6832

Email & Skype: info@chipsmall.com Web: www.chipsmall.com

Address: A1208, Overseas Decoration Building, #122 Zhenhua RD., Futian, Shenzhen, China



PhlatLight LED Development Kit Manual

DK-114N Series



Introduction:

PhlatLight LEDs, from Luminus Devices, have been designed from the ground up to enable a new class of illumination and projection systems. Benefiting from a suite of innovations in chip technology, packaging, and thermal management, PhlatLight LEDs allow designers to achieve efficient light engine designs and deliver high brightness solutions.

The DK-114N series of PhlatLight Development Kits was designed for fast and simple evaluation of PhlatLight products. The included electrical and thermal solutions enable customers to easily breadboard or prototype their system without time consuming and costly development of driver boards and heat sinks.

Capable of providing up to 14A and designed to work with all CBT and PT series parts and their associated applications, the DK-114N development kits support various different drive conditions and use scenarios.

Available in single or multiple channel versions, the PhlatLight development kit will reduce development time of a PhlatLight based solution and provide a platform to build from.

Table of Contents

Key Features.	2
Development Kit Contents.	2
Heat Sink and Driver Module	2
Interface Board.	2
Cable Assembly.	3
Thermal Interface Materials and Mounting Hardware	3
Use Instructions.	4
Additional Required Lab Equipment	4
PhlatLight Device Mounting Instructions.	4
Electrical Setup Instructions	5
Operating Instructions	7
Appendix A: Electrical Design Considerations	8
Appendix B: Isolated AC-DC Power Supplies	8
Appendix C: Mechanical Dimensions	10
Appendix D: Specifications of Driver Board	11
Appendix E: Driver Board Schematic	11
Appendix F: Cable and Connector Pinout Info	12
Appendix G: Future Iterations and Features	12

Key Features

- Drive any CBT or PT series PhlatLight LED up to 14A
- Pulse frequencies of greater than 40kHz possible
- Analog current control via on-board potentiometers or external voltage
- Simple current and voltage measurements
- Fast rise and fall times - less than 1 microsecond
- Fast current level switching - less than 5 microseconds

Development Kit Contents

The contents of each PhlatLight DK-114A Development Kit will depend on the number of channels ordered. As shown in Figure 1, each kit includes the following components:

- Interface board
- Heat sink/ driver board assembly
- Cable assemblies
- Thermal interface materials and mounting hardware
- User Manual

Each interface board supports up to 3 channels. For configurations of greater than 3 channels, additional interface boards are included. Additional channels will increase the quantities of each of these components. The following sections describe the components in detail.

This development kit was designed with flexible features to allow for easy evaluation of PhlatLight LEDs. It was not optimized for size or for direct integration in end products. However, the underlying circuit and thermal design can be used as a reference by system designers. To this effect, the complete design files including schematics, mechanical drawings, and bills of materials are available upon request.



Figure 1: Single Channel Evaluation Kit Contents

Heat Sink / Driver Board Assembly

The heat sink and driver board are packaged together and mounted on a common metal substrate (Figure 2). The module can be left as a free-standing assembly on a bench-top or it can be mounted on an optical table by using the standard optical post mounted on the heat sink.



Figure 2: Heat sink / Driver board Assembly

Heat Sink

The heat sink is a high performance, low cost and compact air cooled aluminum extrusion. Measuring only 40 mm x 40 mm x 40mm, the heat sink occupies a very small volume. The typical thermal resistance from heat sink to ambient with the fan in operation is 0.6 °C/ W, thereby enabling significant power dissipation.

The bolt pattern on the front face of the sink allows for easy mounting of all CBT and PT series modules. All modules can be mounted either horizontally or vertically, allowing for easy prototypes of systems.

Driver Board

The driver board, designed around National Semiconductor's LM3433 IC, is designed to provide up to 14A of current to any PT or CBT series PhlatLight LED. The board is mounted close to the heat sink and LED to ensure cable lengths are kept at a minimum (<3"). Longer cable lengths will cause increased current ringing when pulsing the LEDs.

Using a negative-rail, grounded common anode topology, the LM3433 driver board enables the anodes of multiple PhlatLight LEDs to be in electrical contact with each other. There is no need to electrically isolate the anodes of the LEDs from each other or the heat sink.

The driver board is fully capable of driving the LEDs in either CW or pulsed mode. PWM frequencies in excess of 40kHz are feasible. An external function generator is required for generating the pulse trains.

Interface Board

The included interface board is meant to serve as a clean interface from the user supplied lab equipment to the driver boards. Each interface board is capable of routing power and signal control to up to three driver boards. A potentiometer (POT) is included for all three channels to allow for manual adjustment of intensity. Alternatively, the current level can be controlled via a user supplied voltage signal, which allows for analog dimming. Likewise, there are inputs for a user supplied pulse train, which allows for pulsed width modulation (PWM) of the LEDs.

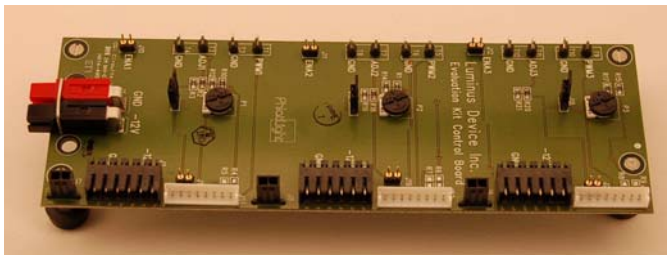

Figure 3: Interface Board

Cable Assembly

Each development kit includes all of the cables necessary for proper setup. The primary cables included are as follows:

- Power supply to interface board
- Interface board to driver board - power
- Interface board to driver board - signal
- Interface board to fan
- Driver board to LED

The interface board to driver board cables (power and signal) and the interface board to fan cable come bundled together. For pinout information, please refer to Appendix F.

In the cases of using any of the C11 package types (PT85, PT120, CBT-85, CBT-90 and CBT-120), the driver board to LED cable is integrated into the driver board.

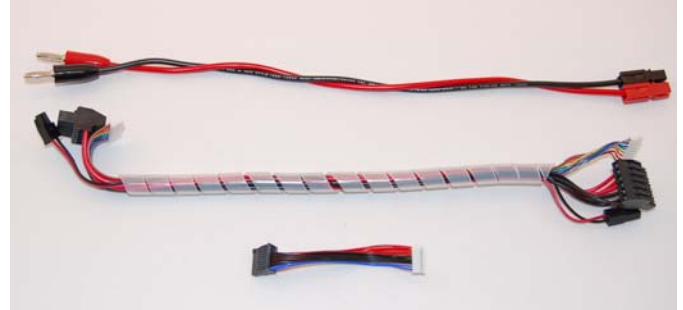

Figure 4: Included Cable Assemblies

For optimum performance, it is not recommended to increase the length of the driver to LED cable. A longer cable will result in decreased performance when pulsing the LEDs.

Thermal Interface Materials (TIMs) and Mounting Hardware

Also included in the kit are precut sheets of a high performance thermal interface material (eGraf HiTherm 1205) and the required mounting hardware for the devices.

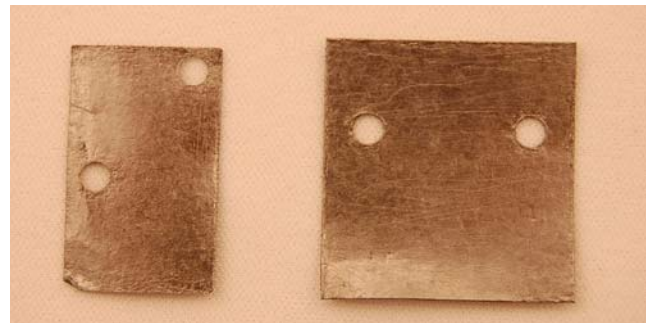

Figure 5: Left picture: TIM cut for C21 package types. Right picture: TIM cut for C11 package types.

Mounting screws for the various package types are included. M2x5 screws are provided for attachment of C21 package types (PT54, PT39, CBT-54 and CBT-40). M2.5x6 screws are provided for attachment of C11 package types (PT85, PT120, CBT-85, CBT-90 and CBT-120).

User Instructions

The following procedure explains how to setup the PhlatLight Evaluation Kit. It is recommended that the table be equipped with ESD protection.

Important Note: The driver board is capable of providing 14A of current to any device. Not all PhlatLight products can be powered at 14A. Care must be taken to ensure the proper current is applied to the device. Consult the product data sheets for current limitations of specific devices.

Equipment Required by User

In order to power and use the development kit, some additional equipment is required. Table 1 lists the type of equipment as well as a suggested part. An additional list of other compatible power supplies is provided in Appendix B.

Important Note: It is very important that the power supply feature an isolated output. If the AC input ground is tied to the DC output ground of the power supply, it will cause damage to the driver board. All of the recommended supplies feature an isolated output. Please refer to Appendix A for more information on these requirements.

Lab Equipment	Recommended Part
12V Lab Power Supply	Lambda ZUP20-20
Oscilloscope	Tektronix TDS 3024B
Waveform Generator	Agilent 33220A
Multimeter	Fluke 187
Photodetector	Thorlabs PDA10A

Table 1: Additional Lab Equipment

PhlatLight Device Mounting Instructions

The following procedure explains the process to properly mount a PhlatLight device to the included heat sink using the included thermal interface material and mounting hardware. The primary goal is to ensure there is good thermal contact between the backside of the copper core-board and the front face of the heat sink.

1. Use a thermal pad of an area slightly larger than the area of the core-board (Figure 6).

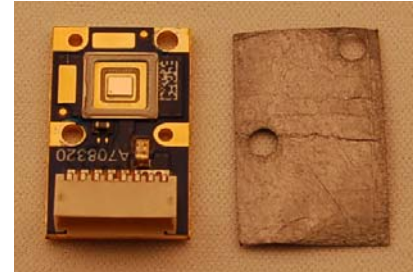

Figure 6: PhlatLight device and an appropriate thermal interface material

2. Prepare the heat sink surface by dusting or removing any particulates that have accumulated on the surface. Place the thermal pad on the heat sink with pre-drilled holes matching the hole pattern on the core board of the device (Figures 7 and 8).

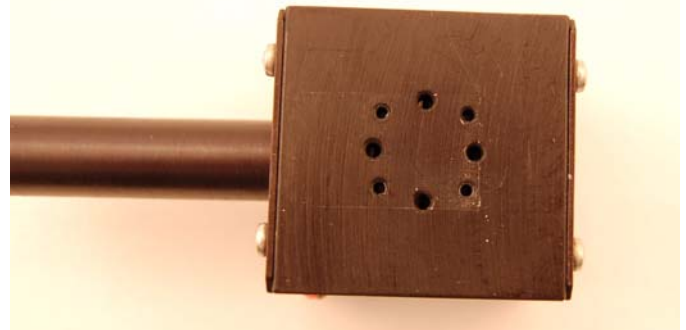

Figure 7: Prepared heat sink with pre-drilled bolt pattern

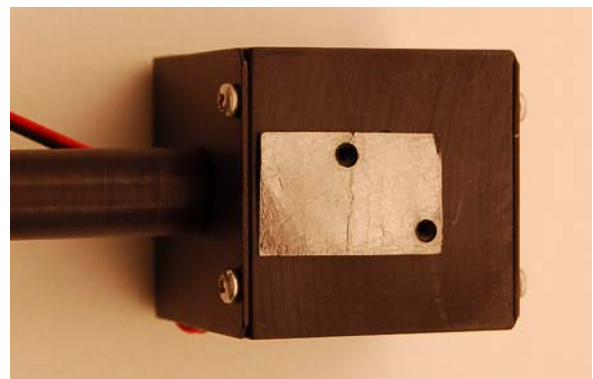

Figure 8: C21 package type thermal interface material placed on heat sink

3. Place the device on the thermal pad, taking care that the hole patterns match (Figure 9).

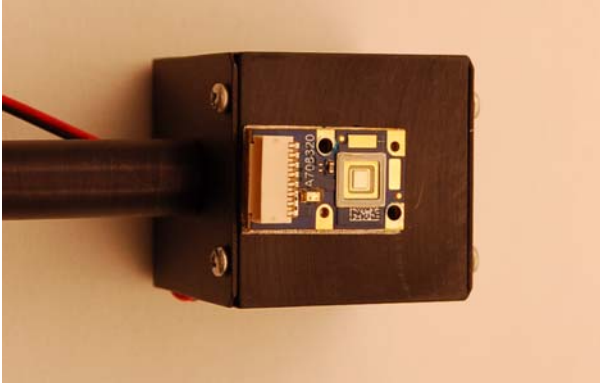

Figure 9: PhlatLight device placed on top of thermal interface material

4. Insert screws in the holes of the coreboard and tighten. To ensure equal pressure is exerted by all screws, alternate tightening each screw until the board is securely fastened (Figure 10). The device is now mounted and ready for electrical connections.

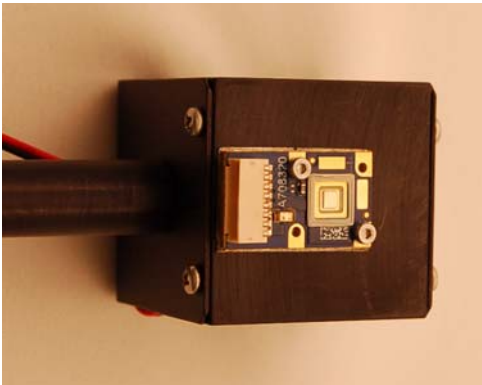

Figure 10: Fully mounted PhlatLight device

Electrical Connections

The following sections assume that the user has all of the equipment listed in Table 1.

1. Prepare the power supply and ensure the power supply being used is capable of providing enough power to the devices. A single channel at full power will draw up to ~80W at 12V and 6.5A. If using a variable power supply like the Lambda ZUP2020, preset the voltage to 12V and set the current to the maximum. Power off the supply until all connections are established and the board settings are ready.
2. Attach all of the wiring included in the kit. The short, 3" cable connects the LED (C21 package types only) to the driver board as shown in Figures 11 and 12. For C11 pack-

age types, a cable is soldered to the board.

The 12" cable assembly, which includes the interface board to driver board cables as well as the interface board to fan cable connects as shown in Figures 13 and 14. The 12" cable assembly, as shown in figure 13, connects the control board to a power supply. This connection is shown in figure 15.

Important Note: In almost all cases, the connectors will only insert in one direction. Care must be taken not to force any of the connections as this may damage the connectors. In the case that the connector can be connected improperly, the connector and mating cable are clearly marked with either color coding or lettering. If powered with improper connections, damage can be caused to the LEDs and circuit boards.

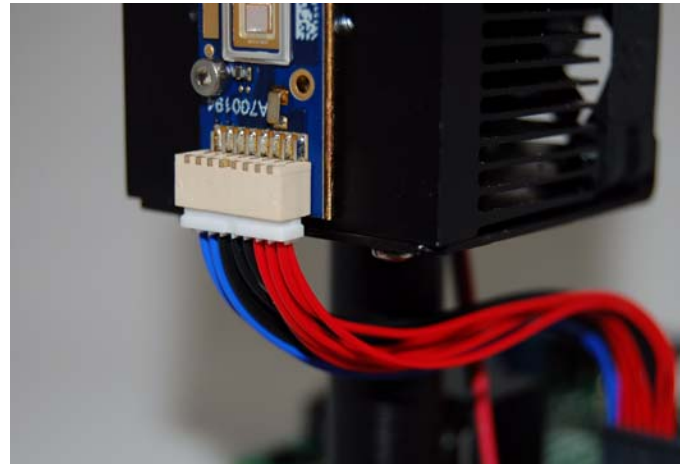

Figure 11: CBT-54 LED to driver board cable interface

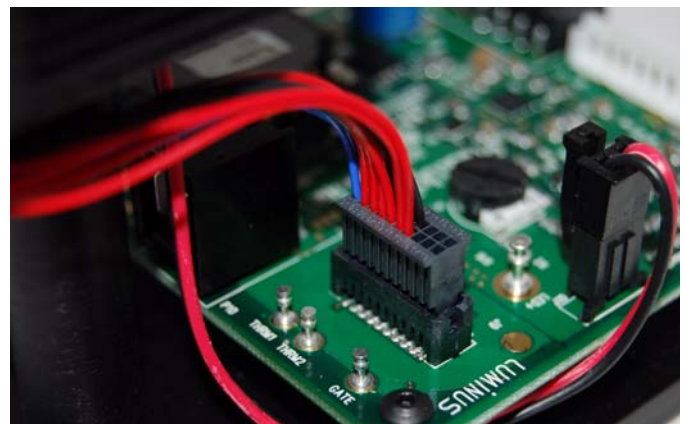

Figure 12: CBT-54 LED to driver board cable interface

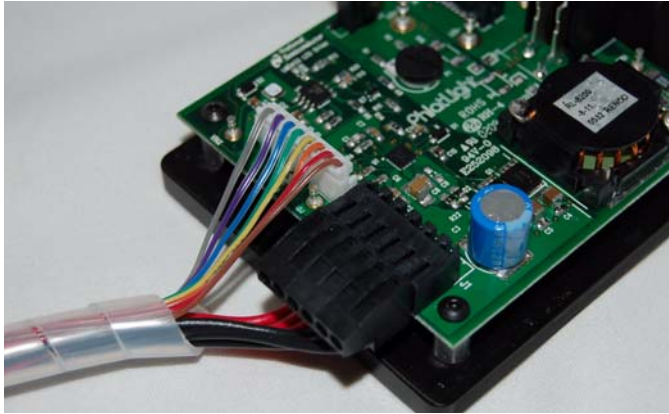

Figure 13: Driver board to interface board cable connections

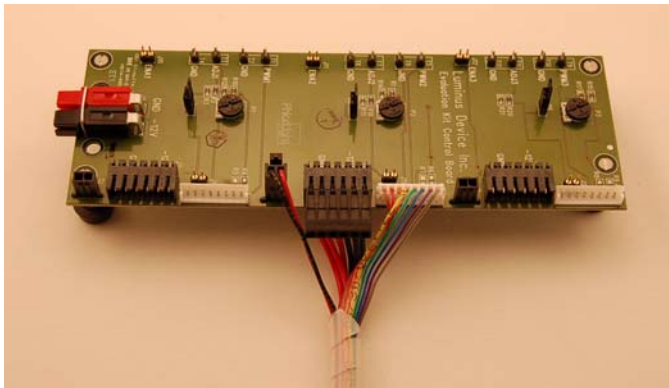

Figure 14: Interface board to driver board cable connections

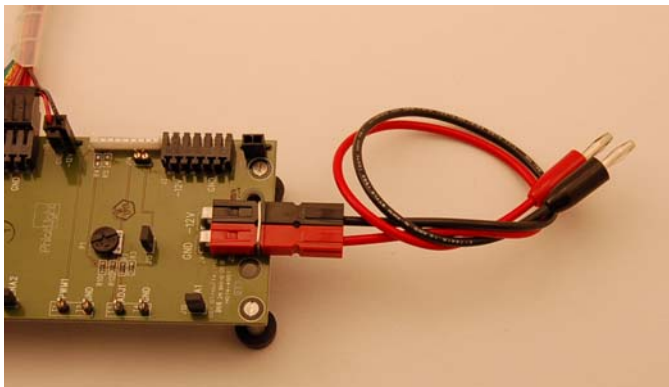

Figure 15: Interface board to power supply cable interface

ables the channel and the other controls functionality of the board.

The enable/disable jumper is located at the positions labeled “ENA1”, “ENA2” and “ENA3”. When these positions are open (not shorted), the channel is enabled. When they are closed (shorted), the channel is disabled.

Position the enable/disable jumpers so that the two pins are closed (shorted).

- For the other jumper, there are three different possible positions for the jumper, each of which enables different functionality with respect to the control of the driver board. It is possible to enable the current controlling POT on the driver board or the POT on the interface board or to control the current via a 0-5V external input. Table 2 details the various different configurations.

Jumper Location	Function
No jumper	External 0-5 V current control
J20 or J19 or J14	Driver POT current control
J18 or J13 or J15	Control board POT current control

Table 2: Control Board Jumper Locations

Position the jumpers as necessary to enable the type of control required.

The locations of these jumpers are shown in Figure 16. The central channel is detailed in the figure. The locations are identical in the other two channels.

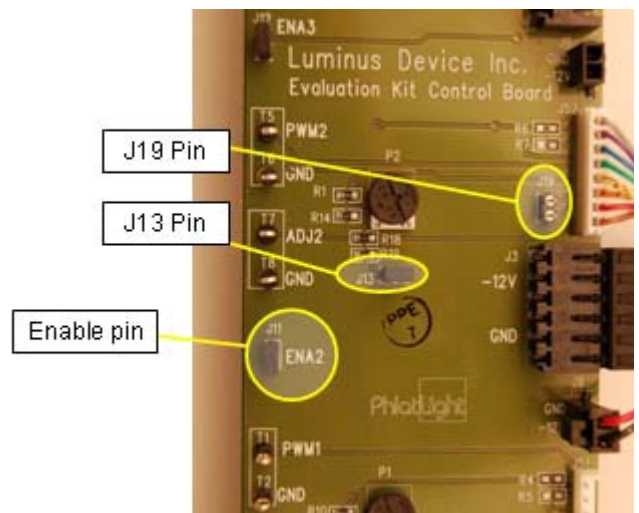

Figure 16: Jumper Locations

- On each channel of the interface board, there are two jumpers mounted. One of these jumpers enables or dis-

- Rotate all of the current controlling POTs (located at “P1”, “P2” and “P3” on the control board and at “P1” on the driver board) counter-clockwise until they stop. The imbedded arrow should point towards the “10” on the POT. The POT is now set at the minimum current setting.
- The evaluation kit is now ready to be powered on. Turn on the power supply. The supply will draw a small amount of power.
- To turn on any channel, open the enable pin by removing the jumper. Both the fan on the heat sink and the LED will power on.

Operating Instructions

There are multiple different ways the PhlatLight DK-114N Development Kit can be operated. The LEDs can be driven in continuous, current controlled mode via on board POTs or through an external analog voltage. Additionally, each channel has inputs for an external function generator or signal to pulse the LEDs and is capable of pulsing at frequencies of greater than 40kHz.

- To change the current when either the interface board or driver board is enabled, rotate the on board POT. Each POT will only function when enabled on the interface board. Clockwise rotation increases the current, while counter-clockwise rotation will decrease the current.
- To change the current when the external adjust is enabled, attach a 0-5V signal to the ADJ test points. These are labeled “T3”, “T4”, “T7”, “T8”, “T11” and “T12”. Each test point is also labeled with either “GND” or “ADJ”. When hooking up the 0-5V signal, ensure that the ground cable is attached to the “GND” test point and the positive cable is attached to the “ADJ” test point.

The current to the LED will adjust with the voltage signal. A higher voltage corresponds with a higher current.

It is recommended not to exceed a 5V signal, as components may overheat.

- To measure the current going to the LED, use a volt meter and measure the voltage across the sense resistor on the driver board. For ease of probing, two test studs have been placed to the left and right of “R15”. Figure 17 shows the location of the test studs on the driver board. Figure 18 shows a conversion plot between the sense resistor voltage and the current going to the LED. The current can also be calculated by the following formula:

$$I_{LED} = \frac{V_{Sense}}{R_{Sense}} \quad \text{Equation 1}$$

where V_{Sense} is the voltage measured across the sense resistor in Volts (V) and R_{Sense} is the value of the sense resistor

in Ohms. The sense resistor value is 0.005Ω. The output value will be the current going to the LED in amps (A).

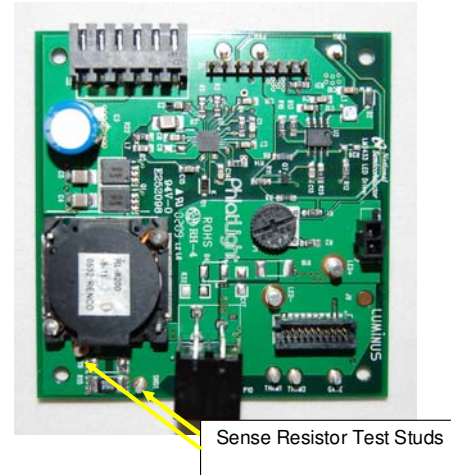

Figure 17: Sense resistor location on driver board

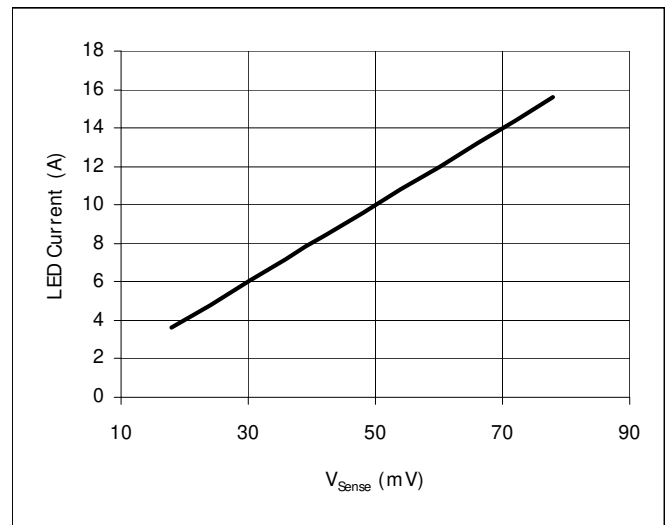

Figure 18: LED Current vs. Vsense voltage

- To modulate the LEDs through PWM, connect a function generator to the test points labeled “PWM” and “GND”. These test points are also labeled “T1”, “T2”, “T5”, “T6”, “T9” and “T10”. The pulse output should be set to 0-5V, where 5V represents off and 0V represents on.

Proper operation is best monitored by using a photo detector to observe the light output from the LED.

Figures 16 - 18 show plots of typical waveforms. The device under test was a blue CBT-54 run at 14A and 50%duty cycle at 30kHz. Actual waveforms will depend on the specific driver

and LED being used.

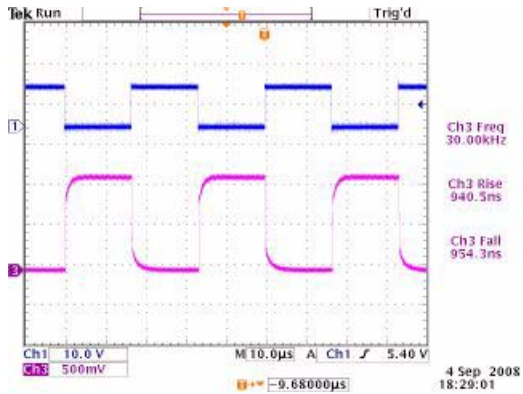

Figure 19: Input and output (optical) pulse

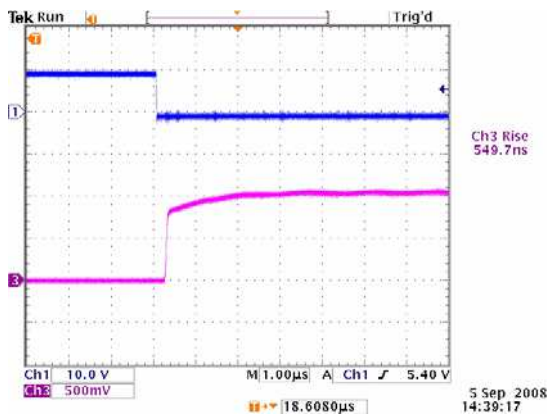

Figure 20: Rise time example

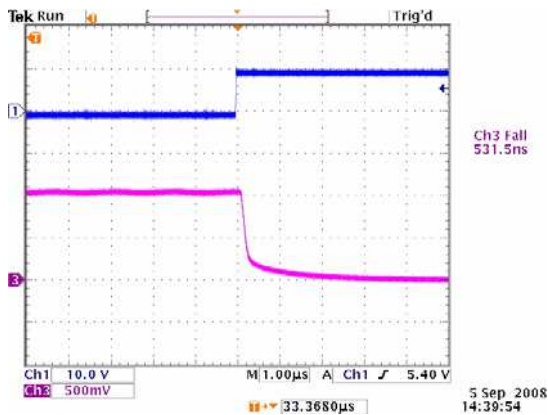

Figure 21: Fall time example

It is important to note that all PT and CBT series PhlatLight LEDs are built in a common anode configuration. That is, the copper core-board is at a positive electrical potential in operation. If this is not factored into the design, it becomes difficult to connect multiple devices to a common heat sink. The DK-114N development kit addresses this by configuring the devices in a grounded common anode topology. As a result, the LED anode is kept at ground and the cathode is at a negative potential. The LED anode can be in direct electrical contact with the heat sink without concern of electrical contact with other LEDs. It is important to note that while the heat sink is at ground, there is still power passing through it. For further information, please contact Luminus.

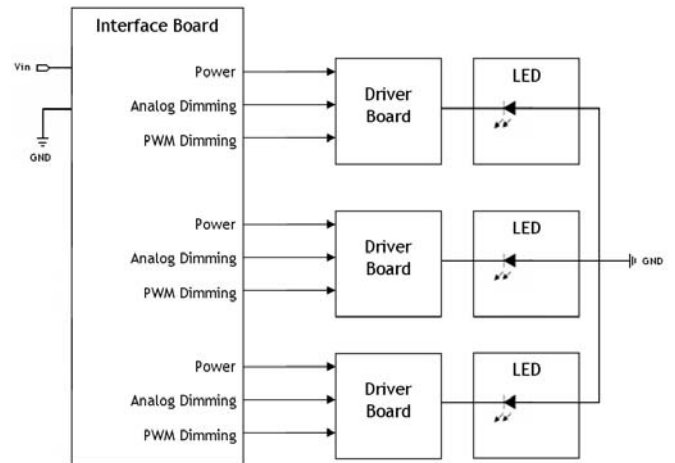

Figure 22: Grounded Common Anode Configuration

This configuration requires that the AC ground line from the supply providing power to the driver board is isolated from the DC ground line. A short list of isolated power supplies is provided in Appendix B.

Appendix B: Isolated AC-DC Power Supplies

Table 3 shows a list of isolated AC-DC power supplies. A power supply with isolated outputs is required to properly drive the DK-114N drivers. Failure to use a similar power supply will result in a malfunctioning board.

Various different power supplies are listed in the table. For best efficiency, it is recommended to select a power supply that closely matches the required power.

Appendix A: Electrical Design Considerations

Power	Manufacturer	Input	Output V/I	Size	Mounting	Part #
30W	CUI Inc.	AC 85-264 VAC (47-400Hz)	12V / 2.5A	3.7" x 2" x 0.85"	Thru-hole/ SMT	FSK-S30-12U
50W	Omron	AC 85-264VAC (47-63Hz)	12V / 4.2A	5" x 3.34" x 1.57"	DIN Rail	S8SP-05005
50W	Lambda Power	AC 90-264VAC (47-63Hz)	12V / 3A	3.62" x 1.46" x 6.26"	Enclosed/ Chassis mount	SWS Series
60W	Globtek Inc.	AC 90-264VAC (47-440Hz)	12V / 5A	5.24" x 2.39" x 1.62"	External/ Desktop	DPS50
75W	Lambda Power	C 90-264VAC (47-63Hz)	12V / 6.3A	3.7" x 1.69" x 6.69"	Enclosed/ Chassis mount	SWS Series
100W	Lambda Power	AC 90-264VAC (47-63Hz)	12V / 8.5A	3.78" x 1.77" x 7.4"	Enclosed/ Chassis mount	SWS Series
100W	Elpac Power	AC 100-264VAC (47-63Hz)	12V / 8.3	7.36" x 4.33" x 2.32"	External/ Desktop	FWP10012- D8F-NC
125W	Power-One So- lutions	AC 90-264VAC (47-63Hz)	12V / 10.5A	5" x 3" x 1.25"	Open Frame	MBP125-1012
120W	AULT Inc.	AC 100-264VAC (47-63Hz)	12V / 10A	9" x 2.9" x 2"	Medical/ External	MW122RA12X XF01
150W	Lambda Power	AC 90-264VAC (47-63Hz)	12V / 12.5A	3.9" x 2" X 7.8"	Enclosed/ Chassis mount	SWS Series

Table 3: List of AC/DC power supplies with an isolated output

Appendix C: Mechanical Dimensions

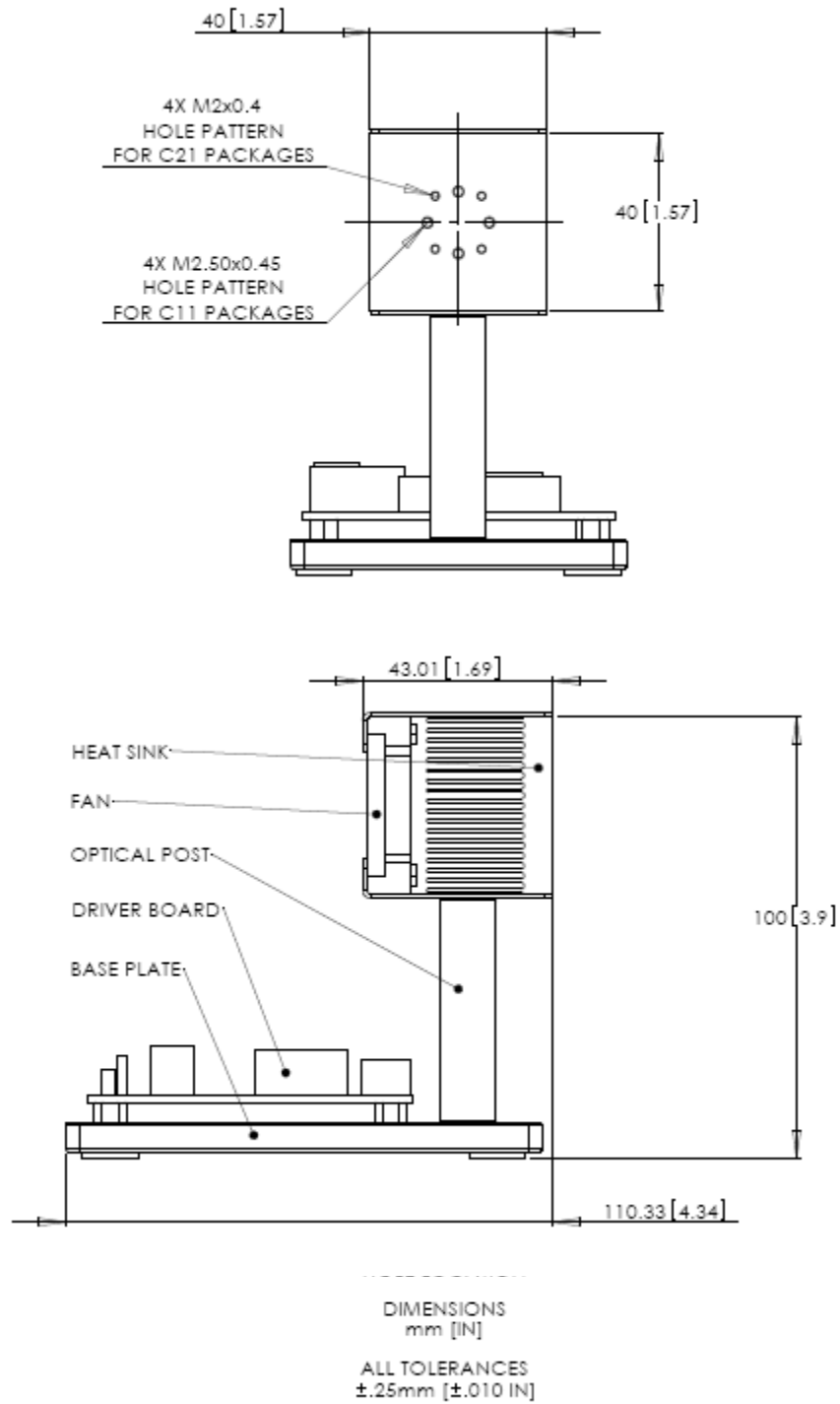

Appendix D: Specifications of Driver

Input Specifications	Value	Unit	Note
Input Voltage	12	V	
Max Supply current/ channel	7	A	
Efficiency	>90	%	
Output Specifications	Value	Unit	Note
Max output current	17	A	
Output current ripple (pulsed)	<10	%	Of set current
Output Pulse Rise time	<1	us	
Output Pulse Fall Time	<1	us	
Output Setting Time	<5	us	min current to max
Control Specifications	Value	Unit	Note
Max Pulse Frequency	>40	kHz	
Duty Cycle Range	0-100	%	

Table 4: Driver board Specifications

Appendix E: Driver Board Schematic and Pinout

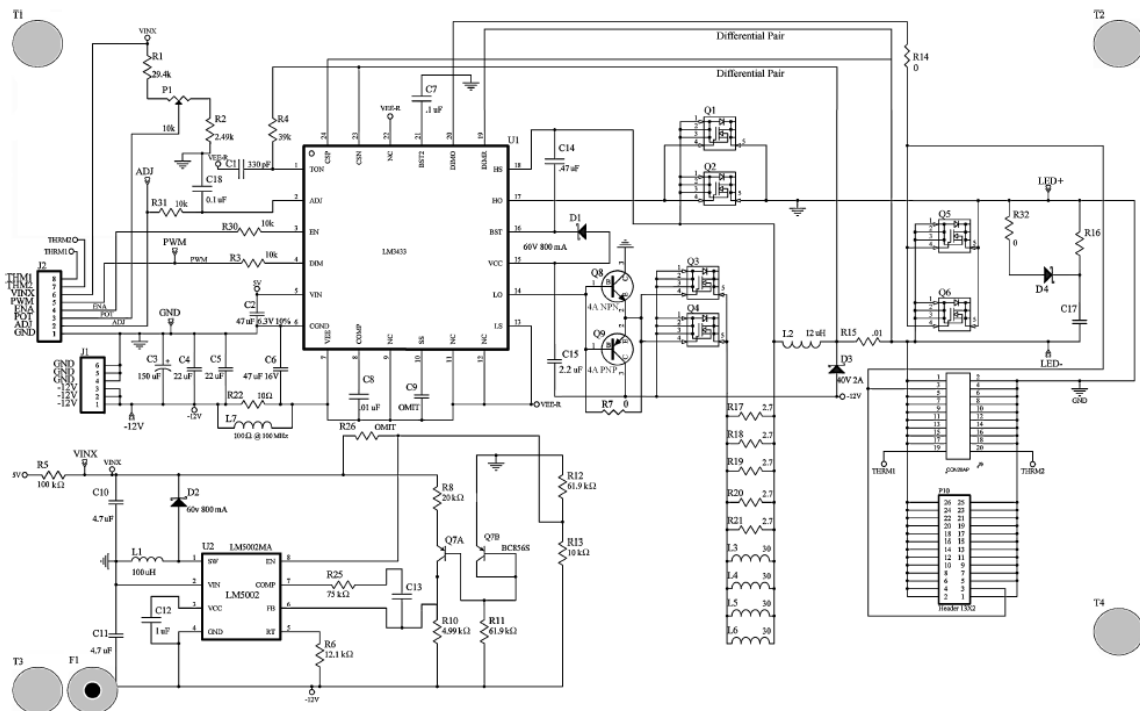

Appendix F: Cable and Connector Pinout Info

Interface Board Pin	Driver Board pin	Comment
Pin 1	Pin 1	GND
Pin 2	Pin 2	Analog ADJ
Pin 3	Pin 3	POT
Pin 4	Pin 4	Enable
Pin 5	Pin 5	PWM
Pin 6	Pin 6	Vinx
Pin 7	Pin 7	Thermistor
Pin 8	Pin 8	Thermistor

Table 5: Interface Board to Driver Board, Signal

Interface Board Pin	Driver Board pin	Comment
Pin 1	Pin 1	-12V
Pin 2	Pin 2	-12V
Pin 3	Pin 3	-12V
Pin 4	Pin 4	GND
Pin 5	Pin 5	GND
Pin 6	Pin 6	GND

Table 6: Interface Board to Driver Board, Power

Interface Board Pin	Fan pin	Comment
Pin 1	Pin 1	+12
Pin 2	Pin 2	GND

Table 7: Interface Board to Fan

Interface Board Pin	Color	Comment
Pin 1	Red	+12
Pin 2	Black	GND

Table 8: Interface Board to Power Supply

LED Pin	Driver Board Pin	Comment
Pin 1	Pin 1	Thermistor
Pin 2	Pin 2	Thermistor
Pin 3	Pin 4 Pin 6	LED Cathode
Pin 4	Pin 8 Pin 10	LED Cathode
Pin 5	Pin 12 Pin 14	LED Cathode
Pin 6	Pin 3 Pin 5	LED Anode
Pin 7	Pin 7 Pin 9	LED Anode
Pin 8	Pin 11 Pin 13	LED Anode

Table 9: LED to Driver Board, C21 Package Style

LED Pin	Driver Board Pin	Color	Comment
Pin 1	N/ A	Green	LED Anode
Pin 2	N/ A	Yellow	LED Cathode

Table 10: LED to Driver Board, C11 Package Style

Appendix G: Future Iterations and Features

Additional features and other enhancements to the development kits are always in process and in development. Among the planned additional features are:

- Thermistor test points for active monitoring of thermistor
- Built-in pulse train generator for simple PWM testing
- Built-in fan controller to regulate junction temperature
- Computer based interface for power and color control

For more information about these features, please contact Luminus Devices.

The products, their specifications and other information appearing in this document are subject to change by Luminus Devices without notice. Luminus Devices assumes no liability for errors that may appear in this document, and no liability otherwise arising from the application or use of the product or information contained herein. None of the information provided herein should be considered to be a representation of the fitness or suitability of the product for any particular application or as any other form of warranty. Luminus Devices' product warranties are limited to only such warranties as accompany a purchase contract or purchase order for such products. Nothing herein is to be construed as constituting an additional warranty. No information contained in this publication may be considered as a waiver by Luminus Devices of any intellectual property rights that Luminus Devices may have in such information. PhlatLight® is a registered trademark of Luminus Devices, Inc., all rights reserved.

This product is protected by U.S. Patents 6,831,302; 7,074,631; 7,083,993; 7,084,434; 7,098,589; 7,105,861; 7,138,666; 7,166,870; 7,166,871; 7,170,100; 7,196,354; 7,211,831; 7,262,550; 7,274,043; 7,301,271; 7,341,880; 7,344,903; 7,345,416; 7,348,603; 7,388,233; 7,391,059; Patents Pending in the U.S. and other countries.

Luminus Devices
1100 Technology Park Dr.
Billerica, MA 01821

978-528-8000 (T)
978-528-8001 (F)

E-mail: sales@luminus.com

www.luminus.com