



Chipsmall Limited consists of a professional team with an average of over 10 year of expertise in the distribution of electronic components. Based in Hongkong, we have already established firm and mutual-benefit business relationships with customers from,Europe,America and south Asia,supplying obsolete and hard-to-find components to meet their specific needs.

With the principle of “Quality Parts,Customers Priority,Honest Operation,and Considerate Service”,our business mainly focus on the distribution of electronic components. Line cards we deal with include Microchip,ALPS,ROHM,Xilinx,Pulse,ON,Everlight and Freescale. Main products comprise IC,Modules,Potentiometer,IC Socket,Relay,Connector.Our parts cover such applications as commercial,industrial, and automotives areas.

We are looking forward to setting up business relationship with you and hope to provide you with the best service and solution. Let us make a better world for our industry!



## Contact us

Tel: +86-755-8981 8866 Fax: +86-755-8427 6832

Email & Skype: info@chipsmall.com Web: www.chipsmall.com

Address: A1208, Overseas Decoration Building, #122 Zhenhua RD., Futian, Shenzhen, China





### Features:

- ◇ Low-cost, high-performance replacement for many OEM DPMs
- ◇ Optional RED, GREEN, AMBER or POS GREEN backlit LCD
- ◇ Snap-in bezel mount eliminates mounting hardware
- ◇ Resistant to RF and EMI
- ◇ 3½ digits with high-contrast LCD
- ◇ 4-20 mA loop powered input
- ◇ User selectable, displayed engineering units

### Specifications:

<b>Display:</b>	Digits:	3 ½ digits (±1999 counts)
	Type:	0.45" (11.4 mm) 7 segment LCD
<b>Backlighting:</b>		Optional Red Negative (red numbers/black background) Optional Green Negative (green numbers/black background) Optional Amber Negative (amber numbers/black background) Optional Green Positive (black numbers/green background)
	Polarity:	automatic, "*" displayed
	Annunciators:	°F, °C, PSI, % , user selectable
	Decimal Points:	3 position, user selectable
	Overrange:	three lower order digits blank for inputs >1999 & < -1999
<b>Inputs:</b>	Ranges:	4-20 mA DC
	Configuration:	bipolar differential
	Impedance:	300Ω nominal
<b>Performance:</b>	Accuracy:	±(0.1% fs + 2 count)
	Conversion Rate:	3 per second
	Normal Mode Rejection:	>30 db @ 60 Hz
	Common Mode Range:	±1 VDC max
	Common Mode Rej.:	>86 dB
	Adjustments:	span (gain) and zero (offset)
	Warmup:	10 minutes typical
	Temperature Coeff.:	± 100 ppm per °C typical
<b>Environment:</b>	Operating Range:	0 to 50 °C
	Storage Range:	-20 to 70 °C
<b>Power Supply:</b>		powered by the milliamp control loop
	Optional Backlight:	24 VDC at 35 mA typical
<b>Mounting:</b>		snap-in bezel mount or clamp and gasket
<b>Connection:</b>		2 screw terminal (4 with backlight)

### Ordering Information:

PART NUMBER	BACKLIGHT COLOR	BACKLIGHT POWER
DK191-XEC	NO BACKLIGHT	NONE
DK192-XEC	NEG AMBER	24VDC
DK194-XEC	NEG RED	24VDC
DK193-XEC	NEG GREEN	24VDC
DK195-XEC	POS GREEN	24VDC

PW2-24.....Regulated 120V AC to 24V DC Power Supply  
 PW1.0..... 24V AC to adjustable DC output  
 CPW1.5..... 24V AC to adjustable DC output  
 CVC..... Calibrator





## Dimensions

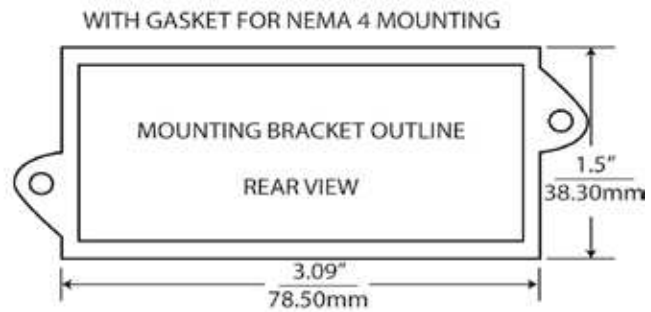
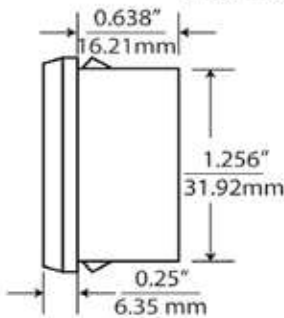
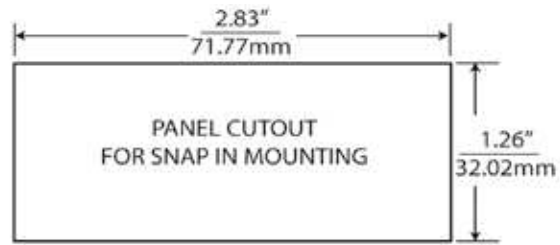
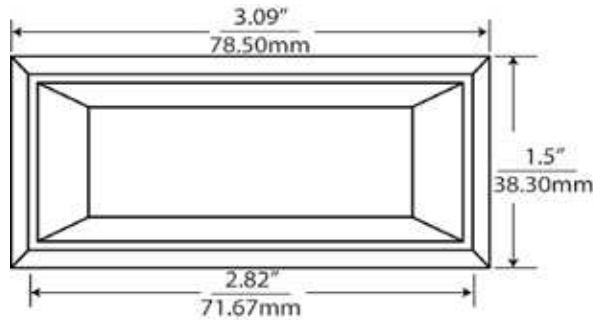

NOTES:  
 1. Panel thickness is: 0.032"/0.81mm to 0.25"/6.35mm  
 2. Gasket supplied is: 0.09"/2.25mm thick

inches  
mm

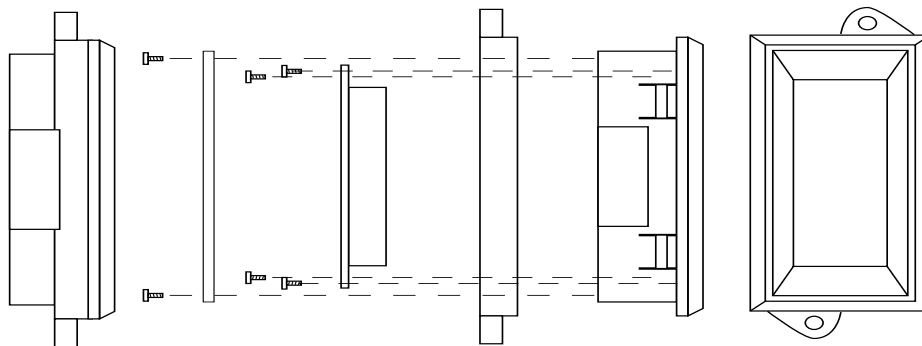

## Jumper Selection & Wiring

### 1. DECIMAL SELECTION:

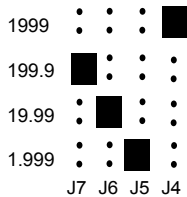

### 2. J1, J2, J3 SELECTION:

**IF:** OFFSET (ZERO) IS 0 **or**  
 OFFSET (ZERO) > 0 **and** GAIN (SPAN) + OFFSET (ZERO) ≥ 5

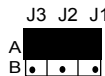

**IF:** OFFSET (ZERO) > 0 **and** GAIN (SPAN) + OFFSET (ZERO) < 5

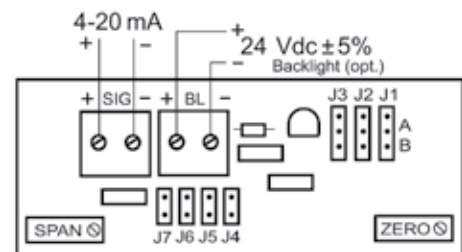
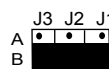

WIRING