



Chipsmall Limited consists of a professional team with an average of over 10 year of expertise in the distribution of electronic components. Based in Hongkong, we have already established firm and mutual-benefit business relationships with customers from,Europe,America and south Asia,supplying obsolete and hard-to-find components to meet their specific needs.

With the principle of “Quality Parts,Customers Priority,Honest Operation,and Considerate Service”,our business mainly focus on the distribution of electronic components. Line cards we deal with include Microchip,ALPS,ROHM,Xilinx,Pulse,ON,Everlight and Freescale. Main products comprise IC,Modules,Potentiometer,IC Socket,Relay,Connector.Our parts cover such applications as commercial,industrial, and automotives areas.

We are looking forward to setting up business relationship with you and hope to provide you with the best service and solution. Let us make a better world for our industry!



Contact us

Tel: +86-755-8981 8866 Fax: +86-755-8427 6832

Email & Skype: info@chipsmall.com Web: www.chipsmall.com

Address: A1208, Overseas Decoration Building, #122 Zhenhua RD., Futian, Shenzhen, China





Features:

- ◇ .45", 3½ digit display
- ◇ Decimal point user selectable
- ◇ Engineering units user selectable
- ◇ Non-backlit LCD or choice of AMBER, GREEN, RED or POS GREEN backlit LCD
- ◇ Wide ZERO (Offset) & SPAN (Gain) adjustment
- ◇ Snap-in panel mounting
- ◇ Gasket and clamp provided for NEMA 4, NEMA 12, & IP66 applications

Specifications:

Display:	Digits:	3 ½ digits (±1999 counts)
	Type:	.45" (11.4 mm) 7 segment high contrast LCD
	Polarity:	automatic, "-" displayed
	Annunciators:	°F, °C, PSI, %, user selectable
	Decimal Points:	3 position, user selectable
	Overrange:	three lower order digits blank for inputs >1999 & < -1999
Inputs:	Voltage Ranges:	5 V, 10 V adjustable, 200mV fixed
	Configuration:	single ended
	Impedance:	390KΩ
Performance:	Accuracy:	±(0.05% of full scale + 1 count)
	Conversion Rate:	3 per second
	Normal Mode Rejection:	>30 dB @ 60 Hz
	Warmup:	10 minutes typical
	Temperature Coeff.:	± 100 ppm per °C typical
Adjustments:		25 turn potentiometers
	Offset Range:	-1999 to +1999
	Gain Range:	1 to 1999 (custom ranges available)
Environment:	Operating Range:	-10 to 50 °C
	Storage Range:	-40 to 75 °C
Power Supply:		12/24 DC
Mounting:		snap-in panel mount or clamp and gasket (included)
Connection:		screw terminals

Ordering Information:

PART NUMBER	BACKLIGHT COLOR	METER INPUT	METER POWER
DK199-XEC	NO BACKLIGHT	Voltage	12/24VDC
DK196-XEC	AMBER	Voltage	12/24VDC
DK197-XEC	GREEN	Voltage	12/24VDC
DK198-XEC	RED	Voltage	12/24VDC
DK200-XEC	POS GREEN	Voltage	12/24VDC

PW2-12	Regulated 120V AC to 12V DC Power Supply
PW2-24	Regulated 120V AC to 24V DC Power Supply
PW1.0	24V AC to adjustable DC output
CPW1.5	24V AC to adjustable DC output
CVC	Calibrator

Voltage Powered LCD Digital Panel Meters

Adjustable Voltage 3 1/2 Digit



DK190V-XEC

Dimensions

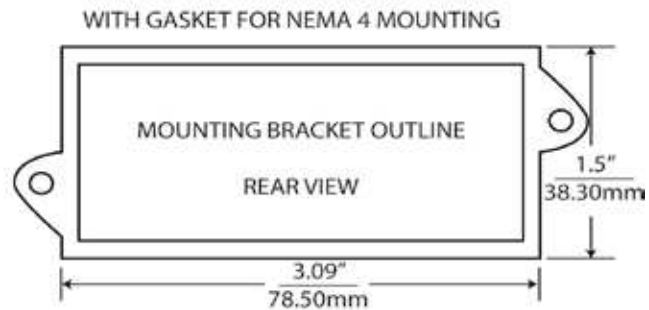
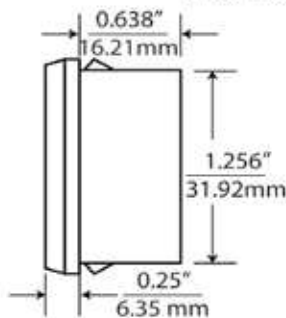
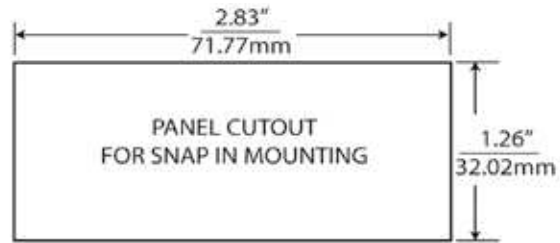
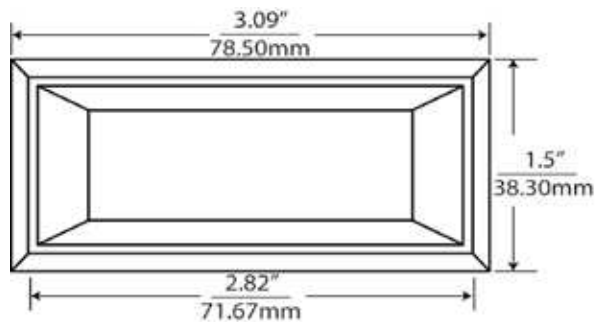

inches
mm

NOTES:

1. Panel thickness is: 0.032"/0.81mm to 0.25"/6.35mm
2. Gasket supplied is: 0.09"/2.25mm thick

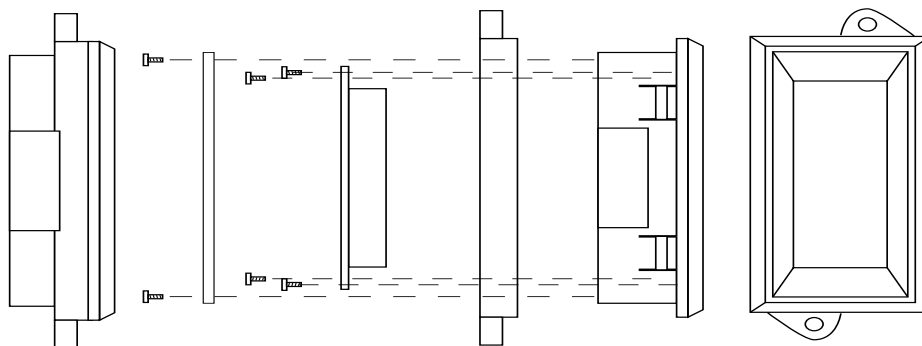

Wiring

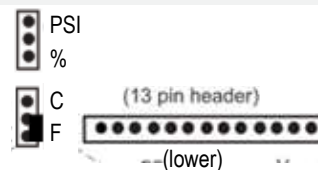
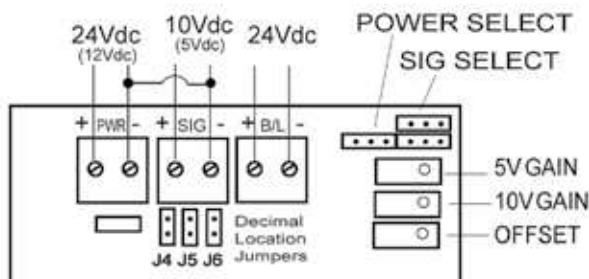

Decimal Point Selection

1. Locate jumpers J4 through J6 in the middle of the circuit board unit.
2. Jumper the appropriate decimal location as follows:
 - J4 - 000.0
 - J5 - 00.00
 - J6 - 0.000
 - None - 0000