



Chipsmall Limited consists of a professional team with an average of over 10 year of expertise in the distribution of electronic components. Based in Hongkong, we have already established firm and mutual-benefit business relationships with customers from,Europe,America and south Asia,supplying obsolete and hard-to-find components to meet their specific needs.

With the principle of “Quality Parts,Customers Priority,Honest Operation,and Considerate Service”,our business mainly focus on the distribution of electronic components. Line cards we deal with include Microchip,ALPS,ROHM,Xilinx,Pulse,ON,Everlight and Freescale. Main products comprise IC,Modules,Potentiometer,IC Socket,Relay,Connector.Our parts cover such applications as commercial,industrial, and automotives areas.

We are looking forward to setting up business relationship with you and hope to provide you with the best service and solution. Let us make a better world for our industry!



## Contact us

Tel: +86-755-8981 8866 Fax: +86-755-8427 6832

Email & Skype: info@chipsmall.com Web: www.chipsmall.com

Address: A1208, Overseas Decoration Building, #122 Zhenhua RD., Futian, Shenzhen, China



Compensated High Current Choke, 1-phase



See below:

**Approvals and Compliances**

**Description**

- Current compensated choke
- 1-phase choke
- THT-terminals
- Flange for mounting onto printed circuit board
- Fully potted resin

**Applications**

- Placed in front of frequency converter
- Stepper motor drives
- UPS-systems
- Inverter

**References**

We recommend for new applications [DKIH-1](#)  
 Last order date: 15.12.2018

**Weblinks**

[pdf datasheet](#), [html-datasheet](#), [General Product Information](#), [Distributor-Stock-Check](#), [Detailed request for product](#)

**Technical Data**

Rated voltage	up to 540VAC	Test Voltage	2.5kV, 50Hz, 2 sec, winding to winding
	up to 760VDC	Isolation Voltage	2.5kV eff., 50Hz, 2 sec, winding to ambient
Rated Current	10 - 20A @ Ta 40 °C	Climatic Category	25/100/21 acc. to IEC 60068-1
Rated inductance	1.1 - 12mH, Tol. -30% +50%	Allowable Operation Temp.	-25°C to 100°C
Power Operating Frequency	50 - 400Hz		
Terminal Type	THT		
Weight	145 - 525g		
Material: Housing	UL 94V-0		
Sealing Compound	UL 94V-0		

**Approvals and Compliances**

Detailed information on product approvals, code requirements, usage instructions and detailed test conditions can be looked up in [Details about Approvals](#)

**Approvals**

The approval mark is used by the testing authorities to certify compliance with the safety requirements placed on electronic products.

Approval Reference Type: DKIL

Approval Logo	Certificates	Certification Body	Description
	UL Approvals	UL	UL File Number:





**Application standards**

Application standards where the product can be used

Organization	Design	Standard	Description
	Designed for applications acc.	IEC/UL 60950	IEC 60950-1 includes the basic requirements for the safety of information technology equipment.

**Compliances**

The product complies with following Guide Lines

Identification	Details	Initiator	Description
	CE declaration of conformity	SCHURTER AG	The CE marking declares that the product complies with the applicable requirements laid down in the harmonisation of Community legislation on its affixing in accordance with EU Regulation 765/2008.
	RoHS	SCHURTER AG	EU Directive RoHS 2011/65/EU
	China RoHS	SCHURTER AG	The law SJ / T 11363-2006 (China RoHS) has been in force since 1 March 2007. It is similar to the EU directive RoHS.
	REACH	SCHURTER AG	On 1 June 2007, Regulation (EC) No 1907/2006 on the Registration, Evaluation, Authorization and Restriction of Chemicals 1 (abbreviated as "REACH") entered into force.

**Dimension [mm]**

Case 31-2P

Case 46-2P

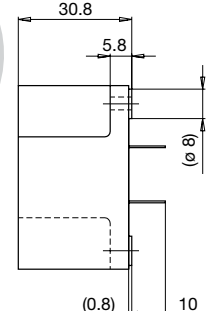
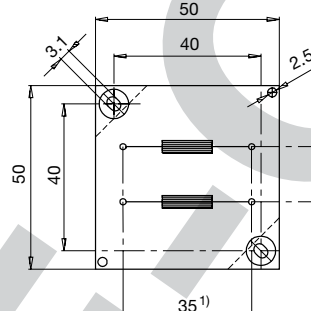
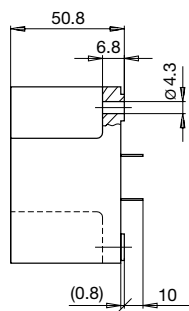
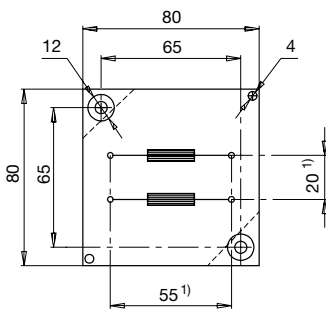

1) Spacing given at pin base

**Impedance curves**

DKIL-0231-xxxx

DKIL-0246-xxxx

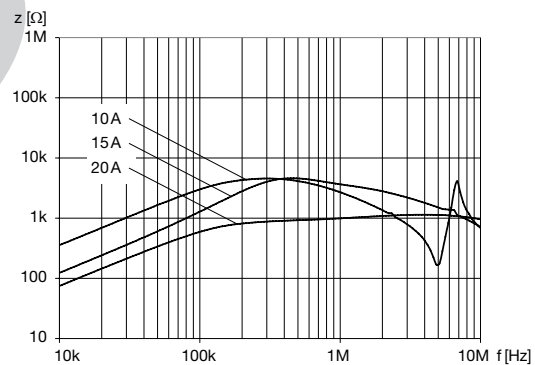
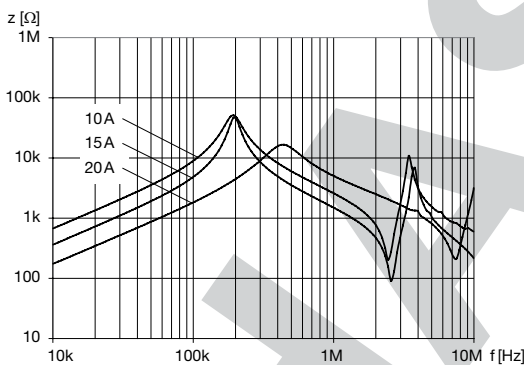

**All Variants**

$I_n$ [A]	$L_n$ [mH]	$R_{cu}$ [mΩ]	Tripped Power Dissipation [W]	$f_{RES}$ [MHz]	Copper $\phi$ [mm]	Weight [g]	Housings	Packing unit [pcs.]	Order Number
10	12	40	8	0.15	1.25	477 g	31-2P	2	DKIL-0231-1012
15	5	17	7.6	0.33	1.6	525 g	31-2P	2	DKIL-0231-1505
20	3	10	8	0.55	1.8	506 g	31-2P	2	DKIL-0231-2003
10	5	18	3.6	0.35	1.25	145 g	46-2P	10	DKIL-0246-1005
15	2	8	3.6	0.6	1.6	145 g	46-2P	10	DKIL-0246-1502
20	1.1	6	4.8	2.5	1.8	145 g	46-2P	10	DKIL-0246-2001

Availability for all products can be searched real-time: <https://www.schurter.com/en/Stock-Check/Stock-Check-SCHURTER>