



Chipsmall Limited consists of a professional team with an average of over 10 year of expertise in the distribution of electronic components. Based in Hongkong, we have already established firm and mutual-benefit business relationships with customers from,Europe,America and south Asia,supplying obsolete and hard-to-find components to meet their specific needs.

With the principle of "Quality Parts,Customers Priority,Honest Operation,and Considerate Service",our business mainly focus on the distribution of electronic components. Line cards we deal with include Microchip,ALPS,ROHM,Xilinx,Pulse,ON,Everlight and Freescale. Main products comprise IC,Modules,Potentiometer,IC Socket,Relay,Connector.Our parts cover such applications as commercial,industrial, and automotives areas.

We are looking forward to setting up business relationship with you and hope to provide you with the best service and solution. Let us make a better world for our industry!



Contact us

Tel: +86-755-8981 8866 Fax: +86-755-8427 6832

Email & Skype: info@chipsmall.com Web: www.chipsmall.com

Address: A1208, Overseas Decoration Building, #122 Zhenhua RD., Futian, Shenzhen, China



Distinctive Characteristics

Various cap styles and colors to meet differing application needs.

Bright, full-face illumination to distinctively indicate status.

Rear panel threaded mounting or snap-in mouser for front panel mounting.

5-amp power rating standard. Dry circuit capability available.

Detent switching mechanism provides positive indication of actuation.

Heavy gauge steel case protects switch components and increases durability.

1,500V dielectric strength between contacts and case is accomplished by clinching the frame away from the terminals.

Solder lug and PC terminals staked into base.

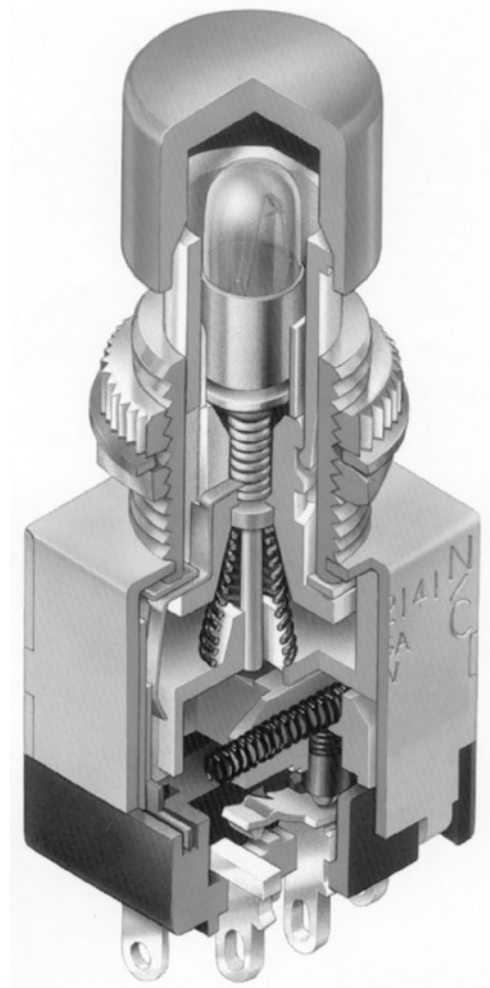

Actual Size

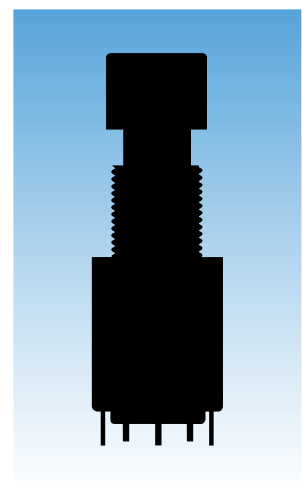

General Specifications

Electrical Capacity (Resistive Load)

Power Level (silver): 5A @ 125V AC & 3A @ 250V AC or 3A @ 30V DC
Logic or Power Level (gold over silver): 0.4VA maximum @ 28V AC/DC maximum or 5A @ 125V AC
 (Applicable Range 0.1mA ~ 0.1A @ 20mV ~ 28V)
 Note: See Supplement section to find explanation of dual rating & operating range.

Other Ratings

Contact Resistance: 10 milliohms maximum for silver; 20 milliohms maximum for gold
Insulation Resistance: 200 megohms minimum @ 500V DC
Dielectric Strength: 1,000V AC minimum between contacts for 1 minute minimum;
 1,500V AC minimum between contacts & case for 1 minute minimum
Mechanical Life: 30,000 operations minimum
Electrical Life: 10,000 operations minimum
Nominal Operating Force: 12.75N for momentary; 11.77N for alternate action
Travel: Pretravel: .039" (1.0mm); Overtravel: .157" (4.0mm); Total Travel: .196" (5.0mm)

Materials & Finishes

Plunger: Polyacetal resin
Bushing: Brass with nickel plating
Housing: Steel with chromate over zinc
Movable Contact: Silver
Stationary Contacts: Silver with silver plating or silver with gold plating
Base: Phenolic resin
Common Terminals: Copper with silver plating
End Terminals: Copper with silver plating or copper with gold plating
Lamp Terminals: Brass with nickel plating

Environmental Data

Operating Temperature Range: -10°C through +50°C (+14°F through +122°F) for spot illuminated
 -20°C through +50°C (-4°F through +122°F) for other illuminated
 -10°C through +50°C (+14°F through +122°F) for nonilluminated
Humidity: 90 ~ 95% humidity for 96 hours @ 40°C (104°F)
Vibration: 10 ~ 55Hz with peak-to-peak amplitude of 1.5mm traversing the frequency range
 & returning in 1 minute; 3 right angled directions for 2 hours
Shock: 50G (490m/s²) acceleration (tested in 6 right angled directions, with 5 shocks in each direction)

Installation

Cap Installation Force: 19.62N (4.41 lbf) maximum downward force on cap
Soldering Time & Temperature: 4 seconds maximum @ 410°C maximum

Standards & Certifications

UL & C-UL Recognition: All models recognized at 5A @ 125V AC;
 UL File No. WOYR2.E44145 & C-UL File No. WOYR8.E44145;
 add "/U" to end of part number to order UL mark on switch & add "/UC" to end of part
 number to order C-UL mark on switch (equivalent to CSA certification).



TYPICAL SWITCH ORDERING EXAMPLE

DLB **2141** **W** **01** — **L** **3** **G** —

POLES & CIRCUITS			
2141	DPDT	ON	(ON)
2145	DPDT	ON	ON

() = Momentary

TERMINALS	
01	Solder Lug
03	Straight PC

SNAP-IN MOUNTER	
No Code	No Mounter
S	Black Mounter for Square Caps
R	Black Mounter for Round Caps

CONTACT MATERIALS & RATINGS	
W	Silver Contacts 5A @ 125V AC
A	Gold over Silver Contacts 5A @ 125V AC & 0.4VA maximum @ 28V AC/DC maximum

LAMPS	
Incandescent & Neon	
E	6-volt
G	14-volt
L	28-volt
*N	110-volt Neon
0	No Lamp

* Neon recommended for cap codes 2 & 3 in white only.

CAP TYPES	
Solid Caps	
1	.748" (19.0mm) Square
2	.346" (8.8mm) Diameter Not for use with Mounter
3	.512" (13.0mm) Diameter Not for use with Mounter
Design Cap	
4	.748" (19.0mm) Diameter with Colored Lens

CAP OR LED COLORS	
Solid & Design Cap Colors	
B	White
C	Red
D	Amber
E	Yellow
F	Green
G	Blue

Note: Colors D & E are not available with Design Cap

LED used with Spot Illuminated	
D	Single Element

Spot Illuminated Caps	
6	.748" (19.0mm) Square
7	.748" (19.0mm) Diameter

LED Colors for Spot Illuminated	
C	Red
F	Green

DESCRIPTION FOR TYPICAL ORDERING EXAMPLE

DLB2141W01-L3G

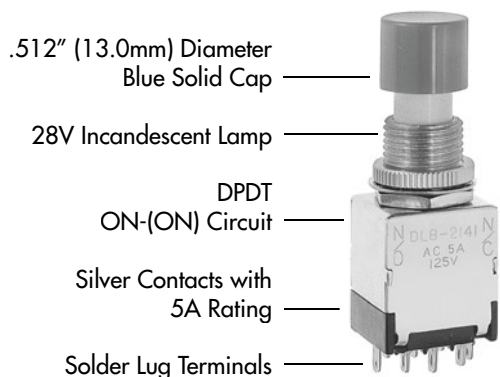

IMPORTANT:



Switches are supplied without UL & C-UL markings unless specified. Specific models & ratings noted on General Specifications page.

POLES & CIRCUITS

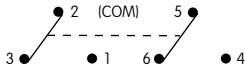
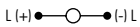
Pole	Model	Plunger Position () = Momentary		Connected Terminals		Throw & Power/Lamp Schematics
		Normal	Down	Normal	Down	
DP	DLB2141 DLB2145	ON ON	(ON) ON	2-3 5-6	2-1 5-4	Notes: Terminal numbers are not actually on the switch. Lamp circuit is isolated and requires an external power source. DPDT  L(+)  L(-)

CONTACT MATERIALS & RATINGS

W

Silver

Power Level

3A @ 125V AC & 250V AC

A

Gold over Silver

Power Level
or Logic Level

5A @ 125V AC
or 0.4VA maximum @ 28V AC/DC maximum

Note: This dual rated option is suitable when two or more identical switches are used in logic and in power circuits within the same application. See Supplement Index for complete explanation of dual rating and operating range.

TERMINALS

01

Solder Lug

Wiring for Solder Lug Terminals

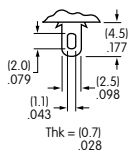

Power terminal hole of .035" x .079" (0.9mm x 2.0mm) accommodates one solid 20-gauge wire or two solid or stranded 22-gauge wires.

Lamp terminal hole of .035" (0.9mm) diameter accommodates one solid 20-gauge wire.

03

Straight PC

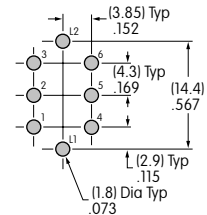
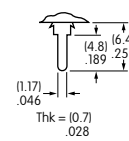

INCANDESCENT & NEON LAMP CODES & SPECIFICATIONS

Electrical specifications are determined at a basic temperature of 25°C.

Lamp circuit is independent of switch operation.

Incandescent & Neon lamps can be used with solid & design caps.

AT604 & AT604N  T-1 3/4 Midget Groove Base	AT604 Incandescent 6-, 14-, or 28-volt; AT604N Neon 110-volt	E	G	L	* N	* Recommended Resistors: 33K ohms for 110V AC; 100K ohms for 220V AC	
	Voltage	V	6V AC	14V AC	28V AC		110V AC
	Current	I	200mA	80mA	40mA		1.5mA
	Endurance	Average Hours	1,000	750	1,000		10,000
	Ambient Temperature Range		-20°C ~ +50°C				

0

No Lamp

Code 0 indicates that no lamp is used with the solid or design caps.