



Chipsmall Limited consists of a professional team with an average of over 10 year of expertise in the distribution of electronic components. Based in Hongkong, we have already established firm and mutual-benefit business relationships with customers from,Europe,America and south Asia,supplying obsolete and hard-to-find components to meet their specific needs.

With the principle of “Quality Parts,Customers Priority,Honest Operation,and Considerate Service”,our business mainly focus on the distribution of electronic components. Line cards we deal with include Microchip,ALPS,ROHM,Xilinx,Pulse,ON,Everlight and Freescale. Main products comprise IC,Modules,Potentiometer,IC Socket,Relay,Connector.Our parts cover such applications as commercial,industrial, and automotives areas.

We are looking forward to setting up business relationship with you and hope to provide you with the best service and solution. Let us make a better world for our industry!



Contact us

Tel: +86-755-8981 8866 Fax: +86-755-8427 6832

Email & Skype: info@chipsmall.com Web: www.chipsmall.com

Address: A1208, Overseas Decoration Building, #122 Zhenhua RD., Futian, Shenzhen, China



DUAL LOOP CONTROLLER



- MODULAR BUILDING BLOCK FOR MULTI-ZONE PROCESS CONTROL
- TWO INDEPENDENT PID CONTROL LOOPS
- PID CONTROL WITH REDUCED OVERSHOOT
- UNIVERSAL INPUTS ACCEPT TC, RTD, 0-10 V AND 0/4-20 mA SIGNALS
- TWO DC ANALOG OUTPUTS (OPTIONAL)
- WINDOWS® CONFIGURATION SOFTWARE
- RS485 MODBUS™ PROTOCOL
- CHANNEL B CAN BE ASSIGNED AS A SECOND ANALOG INPUT TO CHANNEL A FOR REMOTE SETPOINT OPERATION
- SETPOINT CONTROLLER OPTION FOR TIME VS. TEMP./PROCESS (RAMP/SOAK) AND SPECIAL BATCH/RECIPE APPLICATIONS
- SQUARE ROOT EXTRACTION FOR FLOW SENSOR APPLICATIONS

GENERAL DESCRIPTION

The Model DLC, Dual Loop Controller, is a full featured, DIN rail mounted, dual input PID controller. The DLC is designed as a modular building block for multi-zone process control applications. The controller has two independent "A" & "B" input channels. Each channel's input can be configured to accept a wide range of thermocouple, RTD, 0-10 V, 0/4-20 mA, or resistive signals. Each channel can also be configured to extract the square root of the input in both process voltage or process current modes for applications such as flow measurement using a differential flow sensor.

Channel B can be assigned as a Remote Setpoint for Channel A. The two time-proportioning or DC Analog outputs can be programmed to control two independent processes. The two alarms per channel can be configured for various alarm modes, or provide a secondary control output for heat/cool applications.

The control and alarm outputs are N channel open drain MOSFETs capable of switching up to 1 Amp DC. For applications requiring larger loads or A/C loads, several DIN rail mount relays are available.

The controller operates in the PID Control Mode for both heating and cooling, with on-demand auto-tune, that establishes the tuning constants. The PID tuning constants may be fine-tuned through the serial interface. The controller employs a unique overshoot suppression feature, which allows the quickest response without excessive overshoot. The controller can be transferred to operate in the Manual Mode, providing the operator with direct control of the output, or the On/Off Control Mode with adjustable hysteresis.

The controller's high density packaging and DIN rail mounting saves time and panel space. The controller snaps easily onto standard top hat (T) profile DIN rails.

SAFETY SUMMARY

All safety related regulations, local codes and instructions that appear in the manual or on equipment must be observed to ensure personal safety and to prevent damage to either the instrument or equipment connected to it. If equipment is used in a manner not specified by the manufacturer, the protection provided by the equipment may be impaired.

Do not use the controller to directly command motors, valves, or other actuators not equipped with safeguards. To do so can be potentially harmful to persons or equipment in the event of a fault to the controller. An independent and redundant temperature limit indicator with alarm outputs is strongly recommended.

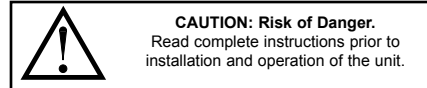

ALARMS

The DLC's two solid-state alarms can be configured independently for absolute high or low acting with balanced or unbalanced hysteresis. They can also be configured for deviation and band alarm. In these modes, the alarm trigger values track the setpoint value. Adjustable alarm trip delays can be used for delaying output response. The alarms can be programmed for Automatic or Latching operation. Latched alarms must be reset with a serial command. A standby feature suppresses the alarm during power-up until the temperature stabilizes outside the alarm region. The outputs can also be manually controlled with Modbus register or coil commands.

SETPOINT CONTROLLER OPTION

The Setpoint Controller option is suitable for time vs. temperature/process control applications. The controller allows a profile of up to 20 ramp/soak segments. Profile conformity is assured by using the Error Band Mode and Error Band parameter. The Profile Cycle Count allows the profile to run continuously or a fixed number of cycles. Power-on options automatically stop, abort, start, resume, or pause a running profile.

ORDERING INFORMATION

MODEL NO.	DESCRIPTION	PART NUMBERS
DLC	Dual Loop Controller	DLC00001
	Dual Loop Controller w/ 2 Analog Outputs	DLC01001
	Dual Setpoint Controller w/ 2 Analog Outputs	DLC11001
SF	PC Configuration Software for Windows	SFDLC
CBPRO	Programming Interface Cable	CBPRO007
CBJ	Cable RJ11 to RJ11 (6 inch jumper)	CBJ11BD5
DRR	RJ11 to Terminal Adapter	DRRJ11T6
	RS485 to RJ11 Cable	CBLRLC00

See our RSRLYB, RLY6, and RLY7 literature for details on DIN rail mountable relays.

DIMENSIONS In inches (mm)

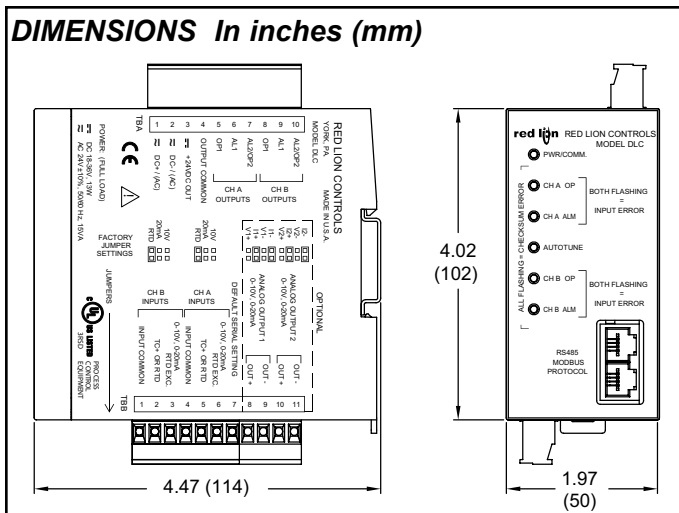

COMMUNICATIONS

The RS485 serial communications allows the DLC to be multi-dropped, with Baud rates up to 38400. The CBPRO007 programming cable converts the RS232 port of a PC to RS485 and is terminated with an RJ11 connector. The bi-directional capability of the CBPRO007 allows it to be used as a permanent interface cable as well as a programming cable.

SOFTWARE

The DLC is programmed with Windows® based SFDLC software. The software allows configuration and storage of DLC program files, as well as calibration. Additionally, all setup and control parameters can be interrogated and modified through MODBUS™ register and coil commands.

ANALOG OUTPUT OPTION

The optional dual DC Analog Output (10 V or 20 mA) can be independently configured and scaled for control or re-transmission purposes. These outputs can be assigned to separate channels, or both outputs can be assigned to the same channel. Programmable output update time reduces valve or actuator activity.

SPECIFICATIONS

1. POWER:

18 to 36 VDC, 13 W (4 W if +24 VDC Output excitation is unused)
24 VAC, ±10% 50/60 Hz, 15 VA (7 VA if +24 VDC Output excitation is unused)
Must use a Class 2 or SELV rated power supply.

2. **+24 VDC OUTPUT POWER:** 24 VDC, +15%, -5%, 200 mA max

3. **MEMORY:** Non-volatile memory retains all programmable parameters.

4. INPUT:

Sample Time: 100 msec (9.5 Hz)

Failed Sensor Response: Open or shorted (RTD only) sensor coils indication, error code returned in Process Value

Common Mode Rejection: >110 dB, 50/60 Hz

Normal Mode Rejection: >40 dB, 50/60 Hz

Temperature Coefficient: 0.013%/°C

Overvoltage: 50 VDC max

Step Response Time: 300 msec typ., 400 msec max

5. THERMOCOUPLE INPUTS:

Types: T, E, J, K, R, S, B, N, C, linear mV

Input Impedance: 20 MΩ

Lead Resistance Effect: 0.25 μV/Ω

Cold Junction Compensation: Less than ±1°C typical (±1.5°C max) over 0 to 50°C ambient temperature range or less than ±1.5°C typical (2°C max) over -20 to 65°C maximum ambient temperature range.

Resolution: 1° or 0.1° for all types except linear mV (0.1 or 0.01 mV)

TYPE	MEASUREMENT RANGE	WIRE COLOR	
		ANSI	BS 1843
T	-200 to +400°C -328 to +752°F	(+) Blue (-) Red	(+) White (-) Blue
E	-200 to +750°C -328 to +1382°F	(+) Violet (-) Red	(+) Brown (-) Blue
J	-200 to +760°C -328 to +1400°F	(+) White (-) Red	(+) Yellow (-) Blue
K	-200 to +1250°C -328 to +2282°F	(+) Yellow (-) Red	(+) Brown (-) Blue
R	0 to +1768°C +32 to +3214°F	No Standard	(+) White (-) Blue
S	0 to +1768°C +32 to +3214°F	No Standard	(+) White (-) Blue
B	+149 to +1820°C +300 to +3308°F	No Standard	No Standard
N	-200 to +1300°C -328 to +2372°F	(+) Orange (-) Red	(+) Orange (-) Blue
C W5/W6	0 to +2315°C +32 to +4199°F	No Standard	No Standard
mV	-5 mV to 56 mV	N/A	N/A

6. RTD INPUTS:

Type: 2 or 3 wire

Excitation: 150 μA

Lead Resistance: 15 Ω max

Resolution: 1 or 0.1° for all types

TYPE	INPUT TYPE	RANGE
385	100 Ω platinum, Alpha = .00385	-200 to +600°C -328 to +1100°F
392	100 Ω platinum, Alpha = .003919	-200 to +600°C -328 to +1100°F
672	120 Ω nickel, Alpha = .00672	-80 to +215°C -112 to +419°F
ohms	Linear Resistance	0 to 320 Ω

7. TEMPERATURE INDICATION ACCURACY: ± (0.3% of span, +1°C).

Includes NIST conformity, cold junction effect, A/D conversion errors, temperature coefficient and linearization conformity at 23 °C after 20 minute warm up.

8. PROCESS INPUT:

INPUT RANGE	ACCURACY* (18 to 28°C) (10 to 75% RH)	IMPEDANCE	MAX CONTINUOUS OVERLOAD	RESOLUTION
10 VDC (-1 to 11)	0.10% of reading +0.02 V	1 MΩ	50 V	1 mV
20 mA DC (-2 to 22)	0.10% of reading +0.03 mA	10 Ω	100 mA	1 μA

* Accuracies are expressed as ± percentages after 20 minute warm-up.

9. ISOLATION LEVEL: 500 VAC @ 50/60 Hz, for one minute (50 V working) between the following groups:

Ch A Input
Ch B Input
Control and Alarm Outputs
RS485/Analog Output¹
Power Supply

Note:

¹ RS485 and Analog Outputs are not internally isolated. Their commons must not be connected together externally for proper unit function (i.e., earth ground).

10. SERIAL COMMUNICATIONS:

Type: RS485; RTU and ASCII MODBUS modes

Baud: 300, 600, 1200, 2400, 4800, 9600, 19200, and 38400

Format: 7/8 bits, odd, even, and no parity

Transmit Delay: Programmable: See Transmit Delay explanation.

Transmit Enable (TXEN): (primarily for 20 mA loop converter) open collector V_{OH} = 10 VDC max, V_{OL} = 0.5 VDC @ 5 mA max current limit

11. A/D CONVERTER: 16 bit resolution

12. CONTROL AND ALARM OUTPUTS:

Type: Non-isolated switched DC, N Channel open drain MOSFET

Current Rating: 1 A max

V_{DS ON}: 0.3 V @ 1 A

V_{DS MAX}: 30 VDC

Offstate Leakage Current: 0.5 mA max

13. MAIN CONTROL:

Control: PID or On/Off

Output: Time proportioning or DC Analog

Cycle Time: Programmable

Auto-Tune: When selected, sets proportional band, integral time, derivative time values, and output dampening time

Probe Break Action: Programmable

14. ALARM: 1 or 2 alarms

Modes:

Manual (through register/coil)

Absolute High Acting (Balanced or Unbalanced Hysteresis)

Absolute Low Acting (Balanced or Unbalanced Hysteresis)

Deviation High Acting

Deviation Low Acting

Inside Band Acting

Outside Band Acting

Reset Action: Programmable; automatic or latched

Standby Mode: Programmable; enable or disable

Hysteresis: Programmable

Sensor Fail Response: Upscale

15. COOLING: Software selectable (overrides Alarm 2).

Control: PID or On/Off

Output: Time proportioning or DC Analog

Cycle Time: Programmable

Proportional Gain Adjust: Programmable

Heat/Cool Deadband Overlap: Programmable

16. ANALOG DC OUTPUTS: (optional)

Control or retransmission, programmable update rate from 0.1 sec or 1 to 250 sec

Step Response Time: 100 msec

OUTPUT RANGE**	ACCURACY* (18 to 28°C) (10 to 75% RH)	COMPLIANCE	RESOLUTION (TYPICAL)
0 to 10 V	0.10% of FS + 1/2 LSD	10 KΩ min	1/18000
0 to 20 mA	0.10% of FS + 1/2 LSD	500 Ω max	1/18000

OUTPUT RANGE**	ACCURACY* (18 to 28°C) (10 to 75% RH)	COMPLIANCE	RESOLUTION (TYPICAL)
4 to 20 mA	0.10% of FS + 1/2 LSD	500 Ω max	1/14400

* Accuracies are expressed as ± percentages after 20 minute warm-up.

** Outputs are independently jumper selectable for either 10 V or 20 mA.
The output range may be field calibrated to yield approximate 10% overrange and a small underrange (negative) signal.

17. ENVIRONMENTAL CONDITIONS:

Operating Temperature Range: -20 to +65°C

Storage Temperature Range: -40 to +85°C

Operating and Storage Humidity: 85% max relative humidity, noncondensing, from -20 to +65°C

Vibration to IEC 68-2-6: Operational 5 to 150 Hz, 2 g

Shock to IEC 68-2-27: Operational 30 g

Altitude: Up to 2000 meters

18. CERTIFICATIONS AND COMPLIANCE:

CE Approved

EN 61326-1 Immunity to Industrial Locations

Emission CISPR 11 Class A

Safety requirements for electrical equipment for measurement, control, and laboratory use:

EN 61010-1: General Requirements

EN 61010-2-030: Particular Requirements for Testing and Measuring Circuits

RoHS Compliant

UL Listed: File #E179259

IP20 Enclosure rating

19. **CONSTRUCTION:** Case body is black high impact plastic. Installation Category I, Pollution Degree 2.

20. **CONNECTIONS:** Wire clamp screw terminals. Removable terminal blocks.

21. **MOUNTING:** Snaps on to standard DIN style top hat (T) profile mounting rails according to EN50022 -35 x 7.5 and -35 x 15.

22. **WEIGHT:** 10.5 oz. (298 g.)

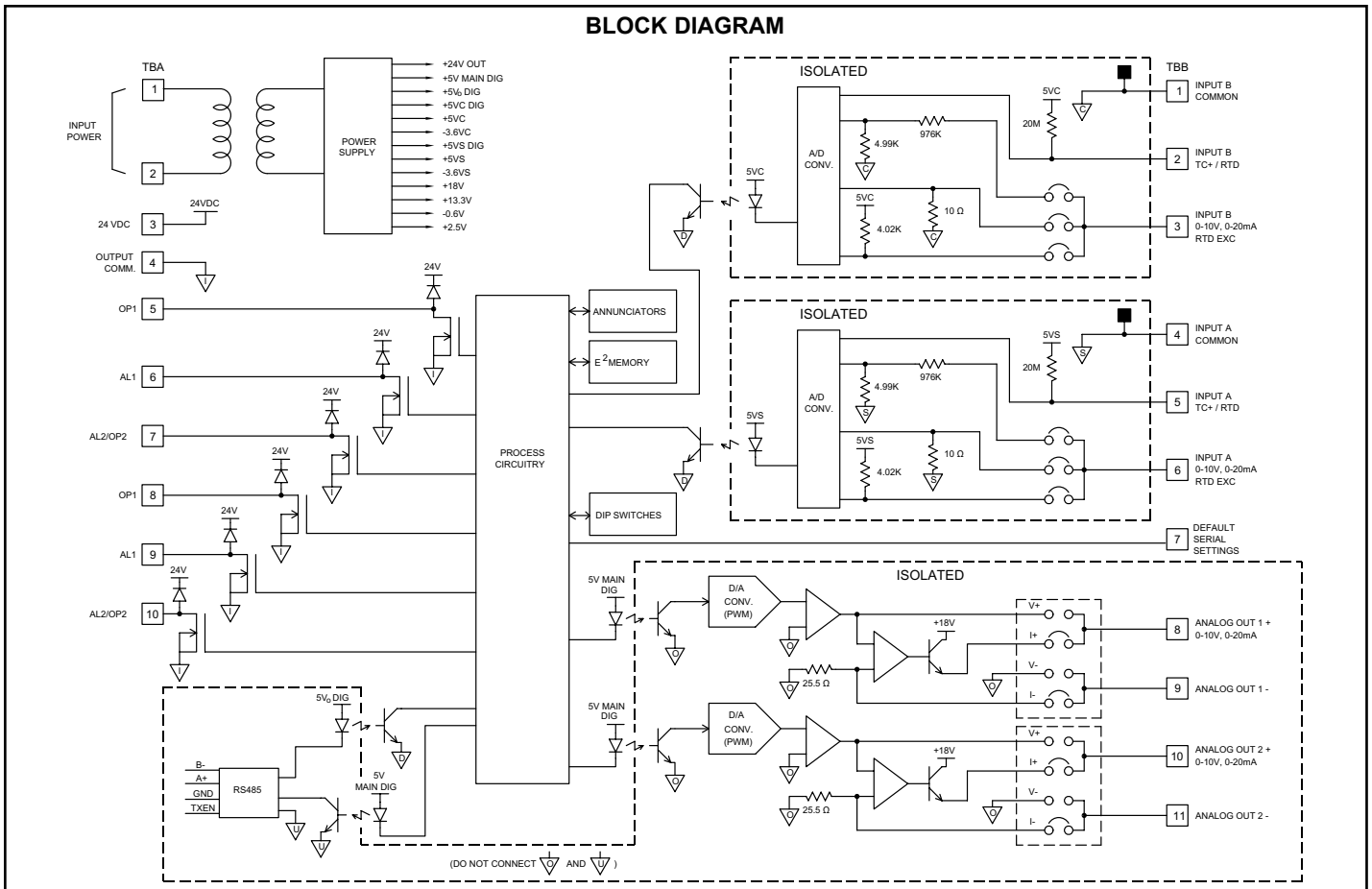

EMC INSTALLATION GUIDELINES

Although Red Lion Controls products are designed with a high degree of immunity to Electromagnetic Interference (EMI), proper installation and wiring methods must be followed to ensure compatibility in each application. The type of the electrical noise, source or coupling method into a unit may be different for various installations. Cable length, routing, and shield termination are very important and can mean the difference between a successful or troublesome installation. Listed are some EMI guidelines for a successful installation in an industrial environment.

1. A unit should be mounted in a metal enclosure, which is properly connected to protective earth.
2. Use shielded cables for all Signal and Control inputs. The shield connection should be made as short as possible. The connection point for the shield depends somewhat upon the application. Listed below are the recommended methods of connecting the shield, in order of their effectiveness.
 - a. Connect the shield to earth ground (protective earth) at one end where the unit is mounted.
 - b. Connect the shield to earth ground at both ends of the cable, usually when the noise source frequency is over 1 MHz.
3. Never run Signal or Control cables in the same conduit or raceway with AC power lines, conductors, feeding motors, solenoids, SCR controls, and heaters, etc. The cables should be run through metal conduit that is properly grounded. This is especially useful in applications where cable runs are long and portable two-way radios are used in close proximity or if the installation is near a commercial radio transmitter. Also, Signal or Control cables within an enclosure should be routed as far away as possible from contactors, control relays, transformers, and other noisy components.
4. Long cable runs are more susceptible to EMI pickup than short cable runs.
5. In extremely high EMI environments, the use of external EMI suppression devices such as Ferrite Suppression Cores for signal and control cables is

effective. The following EMI suppression devices (or equivalent) are recommended:

Fair-Rite part number 0443167251 (Red Lion Controls #FCOR0000)

Line Filters for input power cables:

Schaffner # FN2010-1/07 (Red Lion Controls #LFIL0000)

6. To protect relay contacts that control inductive loads and to minimize radiated and conducted noise (EMI), some type of contact protection network is normally installed across the load, the contacts or both. The most effective location is across the load.
 - a. Using a snubber, which is a resistor-capacitor (RC) network or metal oxide varistor (MOV) across an AC inductive load is very effective at reducing EMI and increasing relay contact life.
 - b. If a DC inductive load (such as a DC relay coil) is controlled by a transistor switch, care must be taken not to exceed the breakdown voltage of the transistor when the load is switched. One of the most effective ways is to place a diode across the inductive load. Most Red Lion products with solid state outputs have internal zener diode protection. However external diode protection at the load is always a good design practice to limit EMI. Although the use of a snubber or varistor could be used.

Red Lion part numbers: Snubber: SNUB0000
Varistor: ILS11500 or ILS23000

7. Care should be taken when connecting input and output devices to the instrument. When a separate input and output common is provided, they should not be mixed. Therefore a sensor common should NOT be connected to an output common. This would cause EMI on the sensitive input common, which could affect the instrument's operation.

Visit <http://www.redlion.net/emi> for more information on EMI guidelines, Safety and CE issues as they relate to Red Lion products.

STEP 1 SETTING THE JUMPERS AND DIP SWITCHES

The jumpers are accessible from the bottom of the controller. Needle-nose pliers are needed to remove the jumpers. They should be set prior to installation. To insure proper operation, the jumpers must match the controller software configuration.

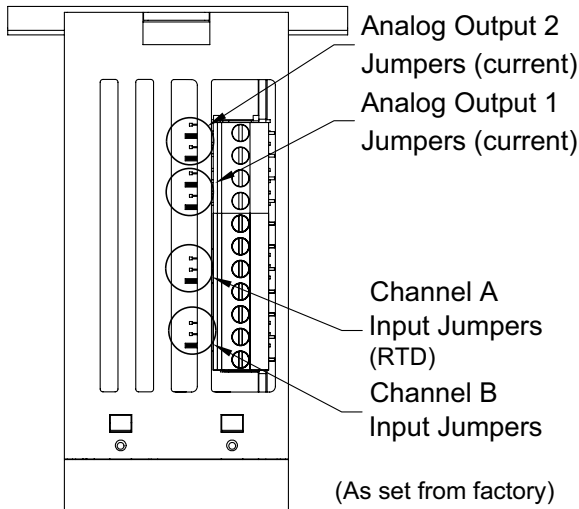

SERIAL DIP SWITCH SETTINGS

The DLC Serial Communications Settings can be set via DIP Switches or through the serial communications port (software selectable). The software selectable serial settings method using the serial communications port must be set using "RLCPRO" or another software program to write to the DLC Modbus registers (40401-40407). When using the DIP switches to configure the serial settings, the Modbus mode is limited to "RTU" mode only.

ANALOG DC OUTPUTS (OPTIONAL)

Analog Output 1 and Analog Output 2 can be configured for voltage (V) or current (I), independent of each other. Both V/I + and V/I - jumpers of the same channel must be set for the same type of output signal.

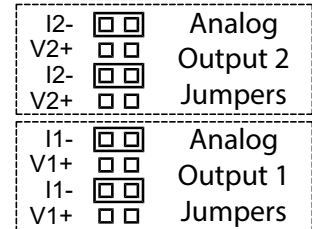

INPUTS

Channel A and Channel B can be configured independent of each other. Jumper position can be ignored for thermocouple and millivolt inputs.

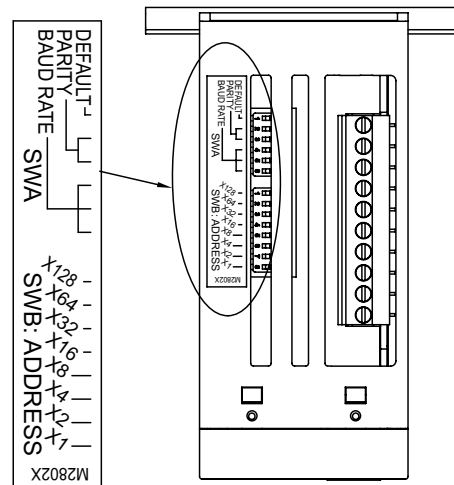
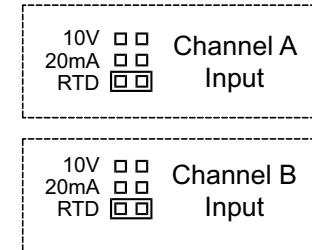

SWA

DEFAULT SERIAL SETTINGS	SWITCH POSITION
	1
Use DIP Switch or Software Serial Settings	DN
Use Default Serial Settings	UP

PARITY	SWITCH POSITION	
	2	3
None	DN	DN
None	DN	UP
Even	UP	DN
Odd	UP	UP

BAUD RATE	SWITCH POSITION		
	4	5	6
300	DN	DN	DN
600	DN	DN	UP
1200	DN	UP	DN
2400	DN	UP	UP
4800	UP	DN	DN
9600	UP	DN	UP
19200	UP	UP	DN
38400	UP	UP	UP

Serial Communication Defaults:

Protocol: RTU **Stop Bit:** 1
Address: 247 **Parity:** none
Baud Rate: 9600 **Start Bit:** 1

SWB

UNIT ADDRESS	SWITCH POSITION / (BIT WEIGHT)							
	1 (128)	2 (64)	3 (32)	4 (16)	5 (8)	6 (4)	7 (2)	8 (1)
Software Selectable Serial Settings	DN	DN	DN	DN	DN	DN	DN	DN
1	DN	DN	DN	DN	DN	DN	DN	UP
2	DN	DN	DN	DN	DN	DN	UP	DN
3	DN	DN	DN	DN	DN	DN	UP	UP
4	DN	DN	DN	DN	DN	UP	DN	DN
5	DN	DN	DN	DN	DN	UP	DN	UP
6	DN	DN	DN	DN	DN	UP	UP	DN
7	DN	DN	DN	DN	DN	UP	UP	UP
8	DN	DN	DN	DN	UP	DN	DN	DN
...								
247*	UP	UP	UP	UP	DN	UP	UP	UP

*- Unit will use address 247 for binary switch settings above 247

STEP 2 INSTALLING THE CONTROLLER

INSTALLATION

The controller is designed for attachment to standard DIN style top hat (T) profile mounting rails according to EN50022 -35 x 7.5 and -35 x 15. The controller should be installed in a location that does not exceed the maximum operating temperature and provides good air circulation. Placing the controller near devices that generate excessive heat should be avoided.

T Rail Installation

To install the DLC on a "T" style rail, angle the controller so that the top groove of the mounting recess is located over the lip of the top rail. Push the controller toward the rail until it snaps into place. To remove a controller from the rail, insert a screwdriver into the slot on the bottom of the controller, and pry upwards until it releases from the rail.

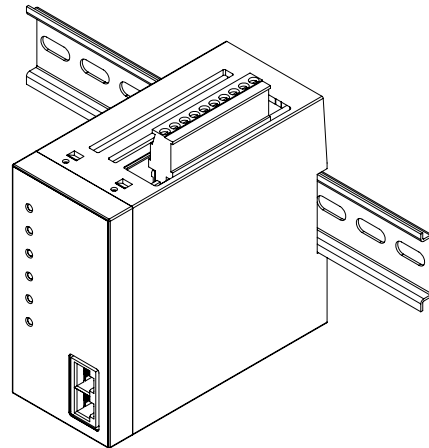

STEP 3 IDENTIFYING THE LEDs - LED FUNCTIONALITY

On power-up, all LEDs are turned on briefly in an alternating pattern to allow visual check of LED functionality.

CONDITION	PRIORITY	PWR/COMM	CH A OP	CH A ALM	AUTOTUNE	CH B OP	CH B ALM
Power Applied	1	On	-----	-----	-----	-----	-----
Communicating	1	Flashing	-----	-----	-----	-----	-----
OP1 On (Channel A) **	4	-----	On	-----	-----	-----	-----
OP1 On (Channel B) **	4	-----	-----	-----	-----	On	-----
AL1 On (Channel A) *	4	-----	-----	On	-----	-----	-----
AL1 On (Channel B) *	4	-----	-----	-----	-----	-----	On
AL2 On (Channel A) *	4	-----	-----	Fast Flashing	-----	-----	-----
AL2 On (Channel B) *	4	-----	-----	-----	-----	-----	Fast Flashing
OP2 On [Cool](Channel A)	5	-----	Fast Flashing	-----	-----	-----	-----
OP2 On [Cool](Channel B)	5	-----	-----	-----	-----	Fast Flashing	-----
Auto-Tune On (Channel A)	3	-----	-----	-----	On	-----	-----
Auto-Tune On (Channel B)	3	-----	-----	-----	Fast Flashing	-----	-----
Input Error (Channel A)	3	-----	Slow Flashing	Slow Flashing	-----	-----	-----
Input Error (Channel B)	3	-----	-----	-----	-----	Slow Flashing	Slow Flashing
Calibration Mode	2	-----	On	On	On	On	On
Checksum Error	1	-----	Slow Flashing	Slow Flashing	Slow Flashing	Slow Flashing	Slow Flashing

* If AL1 & AL2 outputs are on at the same time, the ALM annunciator will alternate between On and Fast Flashing every 1/2 second.

** If OP1 and AL2/OP2 (configured for cool) outputs are on at the same time, the annunciator will only show the OP1 state. The OP2 state is only shown when OP1 is off.

STEP 4 WIRING THE CONTROLLER

WIRING CONNECTIONS

All conductors should meet voltage and current ratings for each terminal. Also, cabling should conform to appropriate standards of good installation, local codes and regulations. When wiring the controller, use the numbers on the label to identify the position number with the proper function. Strip the wire, leaving approximately 1/4" (6 mm) of bare wire exposed. Insert the wire into the terminal, and tighten the screw until the wire is clamped tightly. (Pull wire to verify tightness.) Each terminal can accept up to one #14 AWG (2.55 mm), two #18 AWG (1.02 mm), or four #20 AWG (0.61 mm) wires.

CONTROLLER POWER CONNECTIONS

For best results, the power should be relatively "clean" and within the specified limits. Drawing power from heavily loaded circuits or from circuits that also power loads that cycle on and off should be avoided. It is recommended that power supplied to the controller be protected by a fuse or circuit breaker.

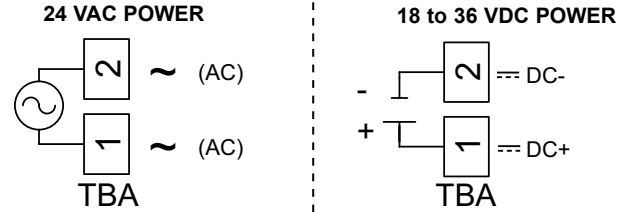

INPUT CONNECTIONS

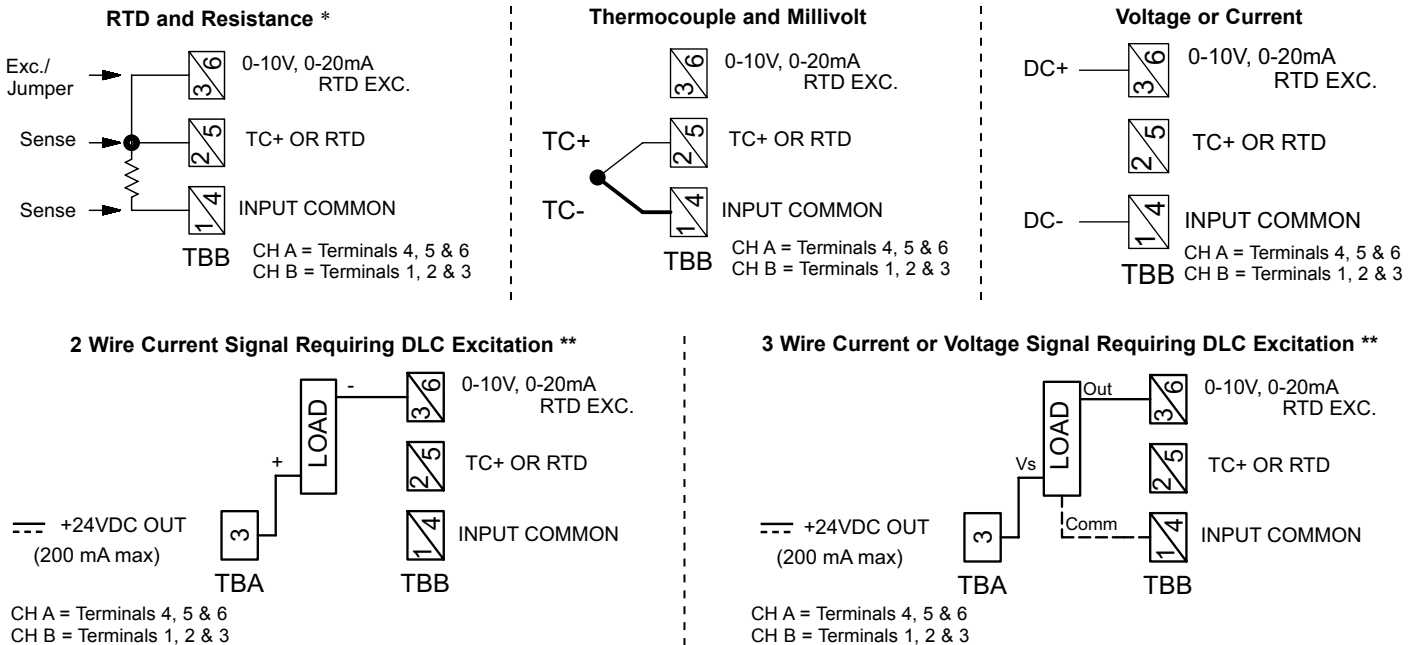

* For two wire RTDs, install a copper sense lead of the same gauge and length as the RTD leads. Attach one end of the wire at the probe and the other end to input common terminal. Complete lead wire compensation is obtained. This is the preferred method. If a sense wire is not used, then use a jumper. A temperature offset error will exist. The error may be compensated by programming a temperature offset.

** +24 VDC OUT (Terminal 3) shares common with Ch A Inputs & All Control/Alarm Outputs.

CONTROL AND ALARM OUTPUT CONNECTIONS

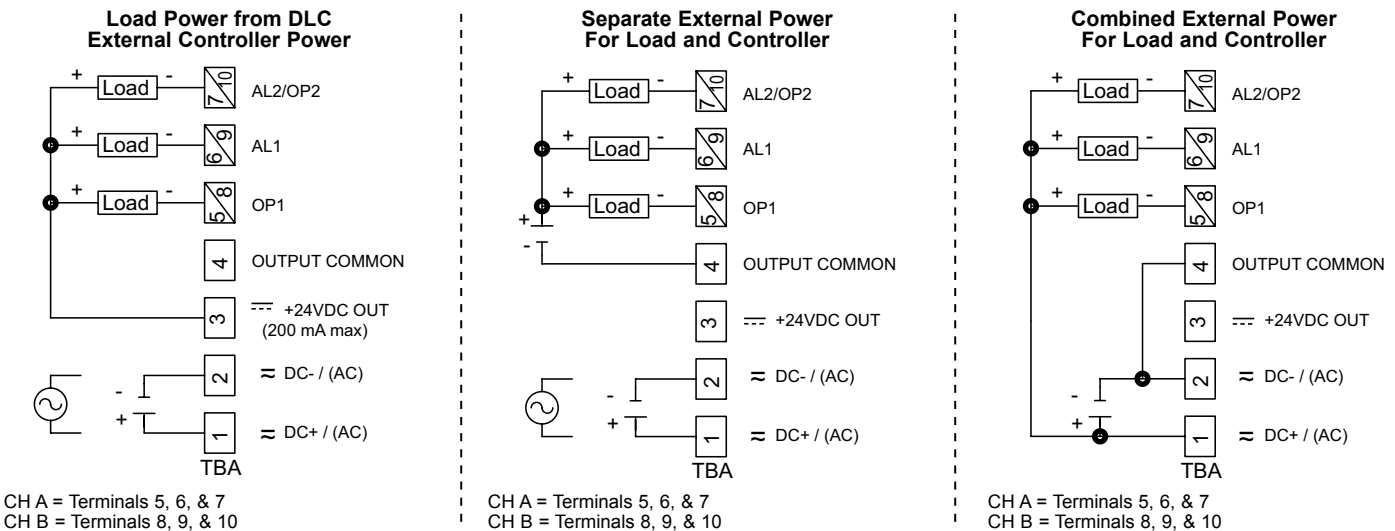

CH A = Terminals 5, 6, & 7
CH B = Terminals 8, 9, & 10

CH A = Terminals 5, 6, & 7
CH B = Terminals 8, 9, & 10

CH A = Terminals 5, 6, & 7
CH B = Terminals 8, 9, & 10

ANALOG DC OUTPUT CONNECTIONS

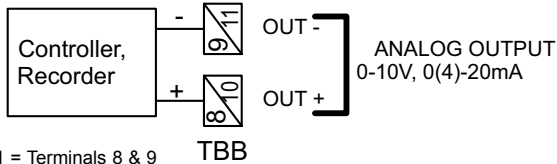

Output 1 = Terminals 8 & 9
Output 2 = Terminals 10 & 11

Note: Analog Outputs & RS485 are not internally isolated and must not share the same common (i.e., earth ground).

DEFAULT SERIAL SETTING CONNECTIONS

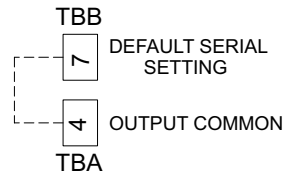

If using software selectable serial settings and the serial settings are unknown or forgotten, they can be temporarily reset to the defaults by connecting the “Default Serial Setting” terminal 7 to “Output Common” terminal 4 with a jumper.

Defaults: Protocol: RTU Data Bits: 8
Address: 247 Parity: none
Baud Rate: 9600

RS485 SERIAL CONNECTIONS

There are two modular connectors located on the front for paralleling communications. The CBPRO007 programming cable converts the RS232 port of a PC to RS485 and is terminated with an RJ11 connector. The bi-directional capability of the CBPRO007 allows it to be used as a permanent interface cable as well as a programming cable.

RJ11	DLC
1	Not used
2	B-
3	A+
4	COMM
5	TXEN
6	Not used

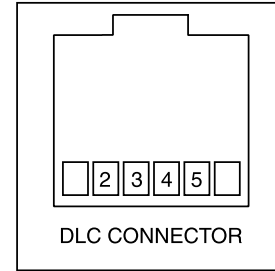

STEP 5 INSTALLING SFDLC (Software for DLC)

After downloading RLCPro for DLC Series (<http://www.redlion.net/SFDLC>) open the ZIP archive and then run dlc207.exe to install the software.

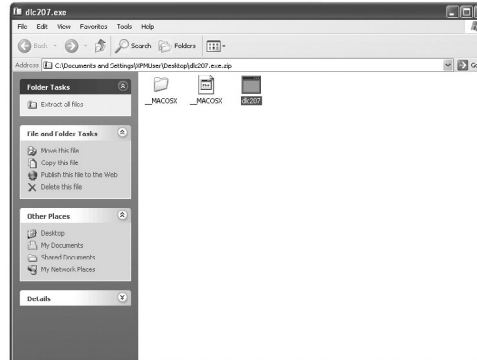

STEP 6 PROGRAMMING - Getting Started

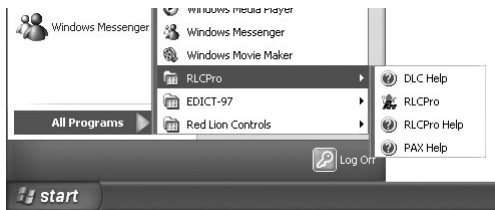

Run RLCPro by double-clicking the icon, or use the start menu.

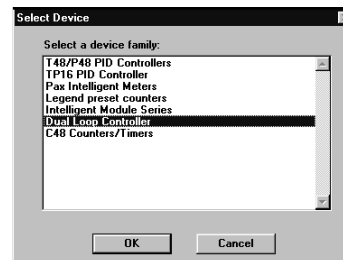

You will be prompted to select the proper device,

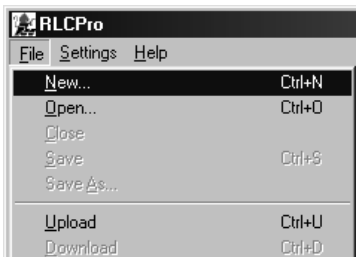

Use the FILE pull-down menu to select a NEW file.

and then the model.

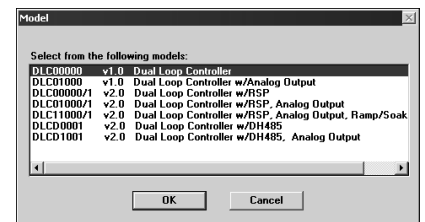

STEP 7 PROGRAMMING THE PID SETTINGS

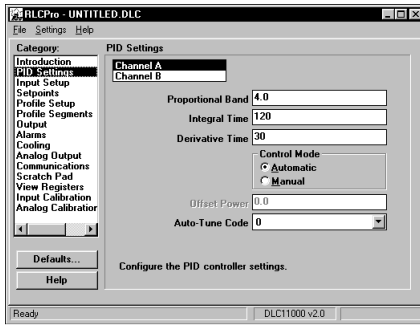

Note: The register numbers correspond to (Channel A/Channel B). Channel B PID control is not functional when the input is assigned as a Remote Setpoint.

The Auto-Tune procedure of the controller sets the Proportional Band, Integral Time, Derivative Time, Digital Filter, Control Output Dampening Time, and Relative Gain (Heat/Cool) values appropriate to the characteristics of the process.

Proportional Band (40007/40023): Proportional band, entered as percent of full input range, is the band from the setpoint where the controller adjusts the percent output power based on how close the process value is to the setpoint. For temperature inputs, the input range is fixed per the entered thermocouple or RTD type. For process inputs, the input range is the difference between the entered Process Low Scaling Value and the Process High Scaling Value. The proportional band should be set to obtain the best response to a process disturbance while minimizing overshoot. A proportional band of 0.0% forces the controller into On/Off Control with its characteristic cycling at setpoint.

Integral Time (40008/40024): Integral time is defined as the time, in seconds, it takes the output power due to integral action alone to equal the output power due to proportional action alone during a constant process error. As long as the error exists, integral action repeats the proportional action each integral time. Integral action shifts the center point position of the proportional band to eliminate error in the steady state. The higher the integral time, the slower the response. The optimal integral time is best determined during PID Tuning. If time is set to zero, the previous Integral output power value is maintained. Offset Power can be used to provide Manual Reset. Integral Action can be disabled by writing a '1' to the Disable Intergral Action register (40044/40052).

Derivative Time (40009/40025): Derivative time, entered as seconds per repeat, is the time that the controller looks ahead at the ramping error to see what the proportional contribution will be and it matches that value every Derivative time. As long as the ramping error exists, the Derivative action is repeated by Proportional action every derivative time. Increasing the derivative time helps to stabilize the response, but too high of a derivative time, coupled with noisy signal processes, may cause the output to fluctuate too greatly, yielding poor control. Setting the time to zero disables Derivative Action.

Control Mode (40041/40049): In Automatic Mode, the percentage of Output Power is automatically determined by PID or On/Off Control. In Manual Mode, the percentage of Output Power is entered manually. For more information, see Control Mode Explanations Section.

Output Power (40005/40021): This parameter can only be changed by direct entry in Manual Mode. For more details on this parameter, see the Control Mode Explanations Section.

Offset Power (Manual Reset) (40010/40026): If the Integral Time is set to zero (Automatic Reset is off), it may be necessary to modify the output power to eliminate errors in the steady state. The offset power is used to shift the proportional band to compensate for errors in the steady state. If Integral Action is later invoked, the controller will re-calculate the internal integral value to provide "bumpless" transfer.

Auto-Tune Code (40013/40029): Prior to starting Auto-Tune, this code should be set to achieve the necessary dampening level under PID Control. When set to zero, it yields the fastest process response with possible overshoot. A setting of 2 yields the slowest response with the least amount of overshoot. If the Auto-Tune Code is changed, Auto-Tune needs to be reinitiated for the changes to affect the PID settings. Auto-tune is initiated by writing a '1' to the Auto-Tune start register (40011/40027). The Auto-Tune phase will be shown in register (40012/40028). For more information, see PID Tuning Explanations Section.

STEP 8 PROGRAMMING THE INPUT SETUP

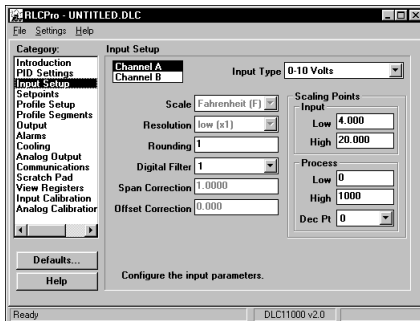

Input Type (40101/40201): Select the proper input type from the pull down menu. Make sure the input jumpers are set to match the input signal selection.

Scale (40102/40202): Select either degrees Fahrenheit or Celsius. For mV, resistance, voltage or current types, this has no effect. If changed, check all temperature related values, as the DLC does not automatically convert these values.

Resolution (40103/40203): For all temperature and ohms Input Types low (x1) resolution selects whole units of measure. In these same modes, high (x10) resolution selects tenths of units of measure. For mV mode, low selects tenths of mV and high selects hundredths of mV. If changed, be sure to check all parameters because the controller does not automatically convert related parameter values. For voltage or current types, this has no effect.

Rounding (40104/40204): Rounding selections other than 1 cause the process value to round to the nearest rounding increment selected. (For example, rounding of 5 causes 122 to round to 120 and 123 to round to 125.) Rounding starts at the least significant digit of the process value. If the signal is inherently jittery, the process value may be rounded to a value higher than 1. If the range of the signal exceeds the required resolution (for example, 0-1000 psi, but only 10 psi resolution is required), a rounding increment of 10 will effectively make the reading more stable.

Digital Filtering (40105/40205): The filter is an adaptive digital filter that discriminates between measurement noise and actual process changes. If the signal is varying too greatly due to measurement noise, increase the filter value. If the fastest controller response is needed, decrease the filter value.

Span Correction (40106/40206): This value is the correction slope. A span of 1.0000 applies no correction. Span only applies to temperature sensor, millivolt, and ohms inputs.

Offset Correction (40107/40207): This value offsets the temperature value by the entered amount. Offset only applies to temperature sensor, millivolt, and ohms inputs

Channel B Assignment (40198): This is used to configure Channel B to operate as a Remote Setpoint to Channel A. Channel B PID control is not functional when the input is assigned as a Remote Setpoint.

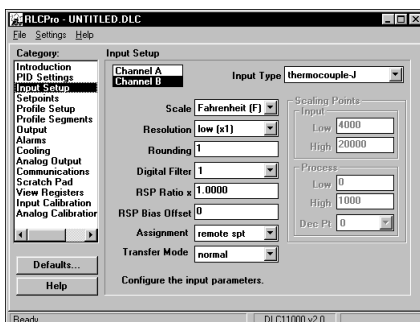

Local/Remote Setpoint Transfer Mode (40199): When cycling from/to Local or Remote Setpoint (register 40046), the response of the controller can be programmed to act in a variety of ways. The table summarizes the responses for Setpoint transfer options.

LOCAL/REMOTE SETPOINT TRANSFER MODE	LOCAL TO REMOTE	REMOTE TO LOCAL
0 - Normal	Output may bump.	Output may bump.
1 - Auto	No output bump. Process error eliminated at rate of integral action. Ramping disabled during transfer.	No output bump. Process error eliminated at rate of integral action. Ramping disabled during transfer.
2 - Track	Output may bump.	Local Setpoint (40002) assumes value of Remote Setpoint (tracks). No output bump.

Note: In situations where an output bump may occur, the Setpoint ramp function can be used to reduce or eliminate bumping when switching Setpoint modes. The setpoint ramp feature ramps the setpoint from the old setpoint to the new Setpoint.

Remote Setpoint Ratio Multiplier (40206): This value is used for channel B when it is assigned as a Remote Setpoint Input. The Ratio Multiplier applies to all input types (0-15).

Remote Setpoint Bias Offset (40207): This value is used for channel B when it is assigned as a Remote Setpoint Input.

Scaling Points (40111-40114/40211-40214): Low and high scaling points are necessary to scale the controller for process voltage and current inputs. Each scaling point has a coordinate pair of input and process value entries. The process value will be linear between and continue past the entries up to the limit of the input range. Reverse acting measurement can be accomplished by reversing the Input or Process entries, but not both. (Do not reverse the input wires to change the action.) To scale a 4-20 mA Input signal to provide process values of 0 to 100.00 (% in hundredths), the Input Low (40113/40213) and Input High (40114/40214) values would be 4000 and 20000 (0.001 mA resolution), and the Process Low (40111/40211) and Process High (40112/40212) values would be 0 and 10000.

Process Decimal Point (Dec Pt) (40115/40215): The decimal point position is used to enable SFDLC display in desired engineering units for voltage and current Process values. It is not used internally by the DLC.

STEP 9 PROGRAMMING THE SETPOINTS

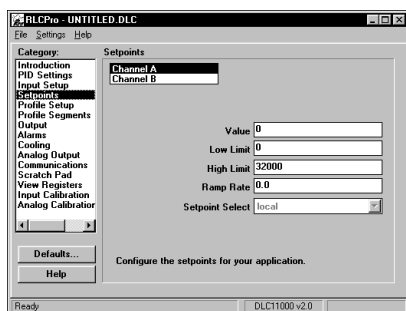

Setpoint (40002/40018): Enter the setpoint value. Deviation of Process Value (40001/40017) from setpoint value can be viewed in the Setpoint Deviation register (40006/40022).

Low Limit (40108/40208); High Limit (40109/40209): The controller has programmable high and low setpoint limit values to restrict the setting range of the setpoint. Set the limits so that the setpoint value cannot be set outside the safe operating area of the process.

Ramp Rate (40110/40210): The setpoint ramp rate can reduce sudden shock to the process and reduce overshoot on startup or after setpoint changes, by ramping the setpoint at a controlled rate. The ramp rate is 0.1° for input types 0-11, 0.1 Ω for input type 12, 0.01 for input type 13, and 0.1 unit for input types 14-15 per minute. Writing a '0' disables setpoint ramping. The Disable Setpoint Ramping register (40042/40050) can also be used to disable ramping. The Setpoint Ramping In-Process register (40043/40051) will be a '1' during setpoint ramping. While ramping is enabled, the Ramping Setpoint can be viewed in register (40045/40053). The Ramp Rate for CHB is not functional when it is assigned as a Remote Setpoint Input.

Once the ramping setpoint reaches the target setpoint, the setpoint ramp rate disengages until the setpoint is changed again. If the ramp value is changed during ramping, the new ramp rate takes effect. If the setpoint is ramping prior to starting Auto-Tune, the ramping is suspended during Auto-Tune and then resumed afterward using the present Process value as a starting value. Deviation and band alarms are relative to the target setpoint, not the ramping setpoint. A slow process may not track the programmed setpoint rate. At power-up, the ramping setpoint is initialized to the starting process value.

Remote/Local Setpoint Select (40046): Channel A setpoint mode can be switched between Local Setpoint operation and Remote Setpoint operation. The Channel B input must be assigned as a remote setpoint (register 40198).

STEP 10 PROGRAMMING PROFILE SETUP (Optional)

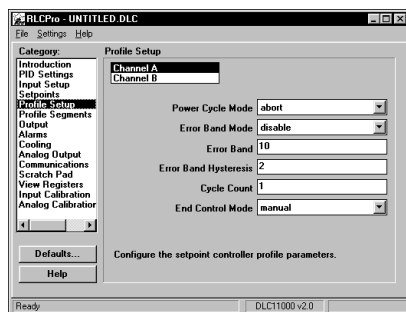

Profile Power Cycle Mode (40321/40421): Upon controller power-on several profile operating modes exist.

Stop: If the Profile was running when powered down, upon power-up, "Stop" places the profile into the stop or off mode, regardless of the mode prior to the power-down. The active Setpoint is the setpoint of the last segment that ran before power-down.

Abort: If the Profile status was running, paused, or in Error Delay when powered down, upon power-up, "Abort" will place the controller in manual mode at 0% Output Power. The Setpoint and Ramp Rate are the values they were prior to running the profile. If the Setpoint Controller was 'paused,' they will be set to the values that they were at power-down.

Start: The Start power cycle mode causes the controller to automatically start the profile at Power-up. This will occur if the unit was in manual or automatic control mode. During maintenance or at other times when this action is not desired, the Profile Power Cycle mode should be changed appropriately.

Resume: At Power-up, Resume causes the profile to continue from the point and phase when power was removed. If the unit was in ramp phase, the ramping setpoint will start ramping from the initial process value at power-up.

Pause: Upon Power-up, the controller pauses and maintains control at the initial process value (on power-up), at the phase where the controller was powered down. The user can then determine how to proceed based on the process that is being controlled.

Profile Error Band Mode (Guaranteed Soak) (40322/40422): Profile conformity can be assured by using the profile Error Band Mode and Error Band parameter. If the process value deviates outside the error band value while a profile is running, the controller enters the delay mode. In the delay mode, the profile phase timer is held (delayed) until the process value is within the deviation error band value - the Error band hysteresis value. At this time, the profile continues running unless the process value again deviates. These actions assure that the actual process value conforms to the profile.

Disable Error Band: Error band operation is disabled.

Ramp Phase Only Error Band: The Profile Error Band only applies to the ramp phases of the running profile.

Hold Phase Only Error Band: The Profile Error Band only applies to hold phases of the running profile.

Ramp & Hold Phase Error Band: The Profile Error Band applies to both ramp and hold phases of the running profile.

Profile Error Band (40323/40423): During a hold phase, the profile is paused when the process error is \geq the Profile Error Band. The profile will remain paused until the process error (deviation) is within the Profile Error Band (Error Band-Error Band Hysteresis).

Profile Error Band Hysteresis (40324/40424): Controls the process value at which the profile will come out of an error band delay. If in error band delay, the profile phase timer is held (delayed) until the process value is within the deviation error band value - the Error band hysteresis value.

Profile End Segment (40325/40425): The Profile End Segment indicates the last segment (i.e., the number of segments to be used in a profile) that is to be ran in the profile before it stops or re-starts (dependent on Profile Cycle Count/Profile Cycle Count remaining).

Profile Cycle Count (40326/40426): Once a profile is started, it runs the number of cycles programmed in this register and then automatically defaults to the Profile End Control Mode. If this parameter is changed while the profile is active, the new value (if less than 250) will not take effect until the profile is stopped and re-started. If the Profile Cycle Count is set to 250 (continuous profile cycling), the change will take affect immediately.

Profile End Control Mode (40327/40427): This parameter sets the type of control action that will be used when the number of profile cycles as programmed in the Profile Cycle Count parameter has run to completion.

Control Outputs Off : Control is turned off by putting the controller in manual mode at 0% Power. Control can be resumed by changing the Control Mode (40041/40049) to Automatic.

Automatic: When configured for Automatic the controller will continue controlling at the last setpoint value.

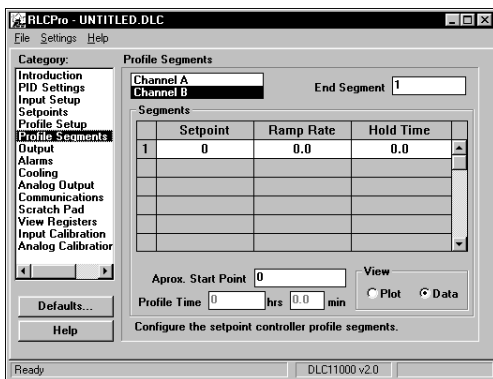

Setpoint Controller Setpoint Segment Registers 1-20 (40601-40620[ChA]/40701-40720[ChB]): The setpoints for the profile are written in these registers. The values are limited by the Setpoint Lo and Setpoint Hi limits registers. Register (40601/40701) is the Setpoint for the 1st segment of the profile.

Setpoint Controller Ramp Rate Segment Registers 1-20 (40621-40640[ChA]/40721-40740[ChB]): The Ramp Rates for the profile are written in these registers. Register (40621/40721) is the Ramp Rate for the 1st segment of the profile. A ramp rate of 0 disables setpoint ramping.

Setpoint Controller Hold Time Segment Registers 1-20 (40641-40660[ChA]/40741-40760[ChB]): The Hold Times for the profile are written in these registers. Register (40641/40741) is the Hold Time for the 1st segment of the profile. Segment Hold times of 0 can be used to achieve a ramp with multiple slopes.

STEP 11 MONITORING PROFILE OPERATION (Optional)

Profile Operating Status/Mode (40065/40073)

Stop/Off: The Stop/Off status indicates the profile is dormant or off. A profile can be stopped by setting this register to 0, by allowing a profile to run to completion, or by removing and re-applying power when the Power Cycle Mode is configured for stop. If the profile was terminated during a ramp phase, the unit will continue to ramp to the active setpoint.

Abort: Abort is a command action that can be used quickly to stop the profile and turn off the control outputs. The controller is placed into manual mode at 0% output power. Following the abort command the Profile Operating Status will go to 0 (Stop/Off).

Run/Start: The profile is in the run mode when it is executing. While running, the profile can be stopped (0), paused (3), or advanced to the next phase. A profile can be started and placed into the Run mode automatically when the controller is powered-up (see Profile Power Cycle Mode). If the profile was previously stopped, when it is placed in to the Run/Start mode (2), the controller will be put into automatic control (if it was in manual) and start the profile at the first segment. If the controller was in manual mode prior to starting the profile, the controller will start ramping from the current process value. If the profile was "paused," it will resume operation. The advancement of the profile can be viewed in the Profile Phase (40066/40074) and Profile Segment register (40067/40075).

Pause: Pause signifies that a profile is active but the time base (Profile Phase Timer) is paused. The pause mode can only be invoked by writing a 3 in the Profile Operating Status register. Pausing a profile during a ramp phase pauses the ramp and the controller maintains control at the ramping setpoint value (40045/40053) at the instant of the pause action. The use of pause, effectively lengthens the total run time of a profile. The unit will remain in pause mode until it is placed back in the run mode by writing a 2 (Run/Start) into the Profile Operating Status Register.

Error Delay (Guaranteed Soak): The Error Delay Setting is used only as a status indication. It indicates that a profile is active but the phase timer or profile advancement has stopped. This is caused by automatic action of the controller when the process deviates more than a specified amount from the active profile segment. The Error Delay is similar to pause, except the error delay status can only be invoked automatically. See "Profile Error Band Mode (40322/40422)." Do not write a "4 - Error Delay," to the Profile Operating Status Register. Doing so will instead put the controller in pause mode (3).

Profile Phase (40066/40074): When the profile is active, this register indicates whether the controller is in a ramp (0) or hold (1) phase.

Profile Segment (40067/40075): Indicates the current active segment while the profile is running. A zero indicates that the profile is stopped or off.

Profile Phase Timer (40068/40076): This register shows the remaining segment phase time in 10ths of minutes. The remaining phase time can be changed "on the fly" to accelerate or decelerate the phase time. The change in phase time will only affect the running profile and not the stored parameters. If the phase time is changed during the ramp phase, a new ramp rate will be calculated which will achieve the desired phase time. The Profile Phase Timer will stop while the unit is paused or during an error delay caused by Profile Error Band operation (guaranteed soak).

Profile Cycle Count Remaining (40069/40077): Indicates the number of profile cycles that are yet to be run. If the Profile Cycle Count register (40326/40426) is set to 250, the Profile Cycle Count Remaining Register will run continuously, resetting to "250" when reaching "0". This register value can be changed, however, it will only affect the current run cycle. When the profile is stopped and re-started, the Profile Cycle Count Remaining Register will be reloaded based on the "Profile Cycle Count (40326/40426)" value.

Advance Profile Phase (40070/40078): Writing a "1" to this register while the profile is running will cause the controller to advance immediately to the beginning of the next ramp or hold phase. Using the advance operation shortens the total run time of the profile. If the profile is "paused," the profile will advance but the profile will remain paused. The Profile can also be advanced while in the error delay mode.

STEP 12 PROGRAMMING THE OUTPUTS

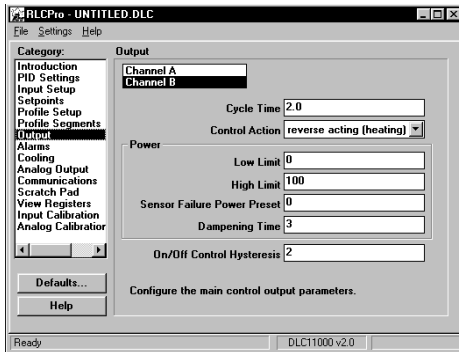

Cycle Time (40116/40216): The cycle time, entered in seconds, is the combined time of an on and off cycle of a time proportioning control output OP1/OP2. With time proportional output, the percentage of control power is converted into output on time of the cycle time value. (If the controller calculates that 65% power is required and has a cycle time of 10 seconds, the output will be on for 6.5 seconds and off for 3.5 seconds.) For best control, a cycle time equal to one-tenth of the process time constant, or less, is recommended. When using the DC Analog output signal for control, a setting of zero will keep output OP1 off. The status of OP1 can be read through registers 40014/40030.

Control Action (40117/40217): This determines the control action for the PID loop. Programmed for direct action (cooling), the DLC output power will increase if the Process value is above the Setpoint value. Programmed for reverse action (heating), the output power decreases when the Process Value is above the Setpoint Value. For heat and cool applications, this is typically set to reverse. This allows OP1 to be used for heating, and AL2/OP2 to be used for cooling.

Power Low Limit (40118/40218); High Limit (40119/40219): These parameters may be used to limit controller power due to process disturbances or setpoint changes. Enter the safe output power limits for the process. If Alarm 2 is selected for cooling, the range is from -100 to +100%. At 0%, both OP1 and OP2 are off; at 100%, OP1 is on; and at -100%, OP2 is on. When the controller is in Manual Control Mode, these limits do not apply.

Sensor Fail Power Preset (40120/40220): This parameter sets the power level for the control outputs in the event of a sensor failure or extreme overdriven/underdriven input. If Alarm 2 is not selected for cooling, the range is from 0% (OP1 output full off) to 100% (OP1 output full on). If AL2 is selected for cooling, the range is from -100 to +100%. At 0%, both OP1 and OP2 are off; at 100%, OP1 is on; and at -100%, OP2 is on. The alarm outputs are upscale drive with an open sensor, and downscale drive with a shorted sensor (RTD only), independent of this setting. Manual Control overrides the sensor fail preset.

Dampening Time (40121/40221): The dampening time, entered as a time constant in seconds, dampens (filters) the calculated output power. Increasing the value increases the dampening effect. Generally, dampening times in the range of one-twentieth to one-fiftieth of the controller's integral time (or process time constant) is effective. Dampening times longer than these may cause controller instability due to the added lag effect.

On/Off Control Hysteresis (40122/40222): The controller can be placed in the On/Off Control Mode by setting the Proportional Band to 0.0%. The On/Off Control Hysteresis (balanced around the setpoint) eliminates output chatter. In heat/cool applications, the control hysteresis value affects both Output OP1 and Output OP2 control. It is suggested to set the hysteresis band to 2 (Factory Setting) prior to starting Auto-Tune. After Auto-Tune, the hysteresis band has no effect on PID Control. On/Off Control Hysteresis is illustrated in the the On/Off Control Mode section.

STEP 13 PROGRAMMING THE ALARMS

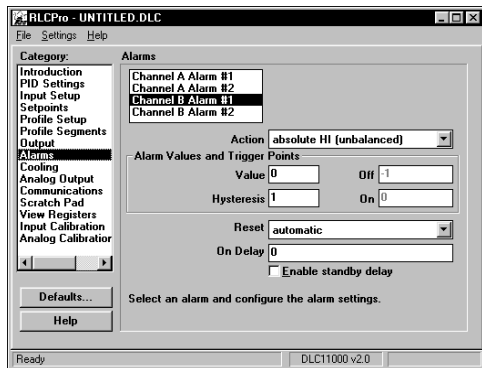

Alarm 1 and 2: The controller is equipped with two alarms for each channel. The status of these alarms can be read through AL1 registers 40015/40031 and AL2 registers 40016/40032.

Action (40131/40231), (40136/40236): Select the action for the alarms. See Alarm Action Figures for a visual explanation.

Manual: In Manual mode, the alarms are forced on and off by writing '0' or '1' to the appropriate alarm output register. In this mode, the alarms will not respond to Alarm and Hysteresis Values.

Absolute HI (balanced or unbalanced hysteresis): The alarm energizes when the Process Value exceeds the alarm.

Absolute LO (balanced or unbalanced hysteresis): The alarm energizes when the Process Value falls below the alarm.

Deviation HI, Deviation LO, Band Acting: In these actions, Alarm 1 and 2 value tracks the Setpoint value.

Cooling (OP2): For heat/cool applications, select Cool for Alarm 2. The controller then utilizes the Alarm 2 output as the Cooling Output (OP2). If cooling is selected, the remaining Alarm 2 parameters are not available.

ALARM ACTION FIGURES

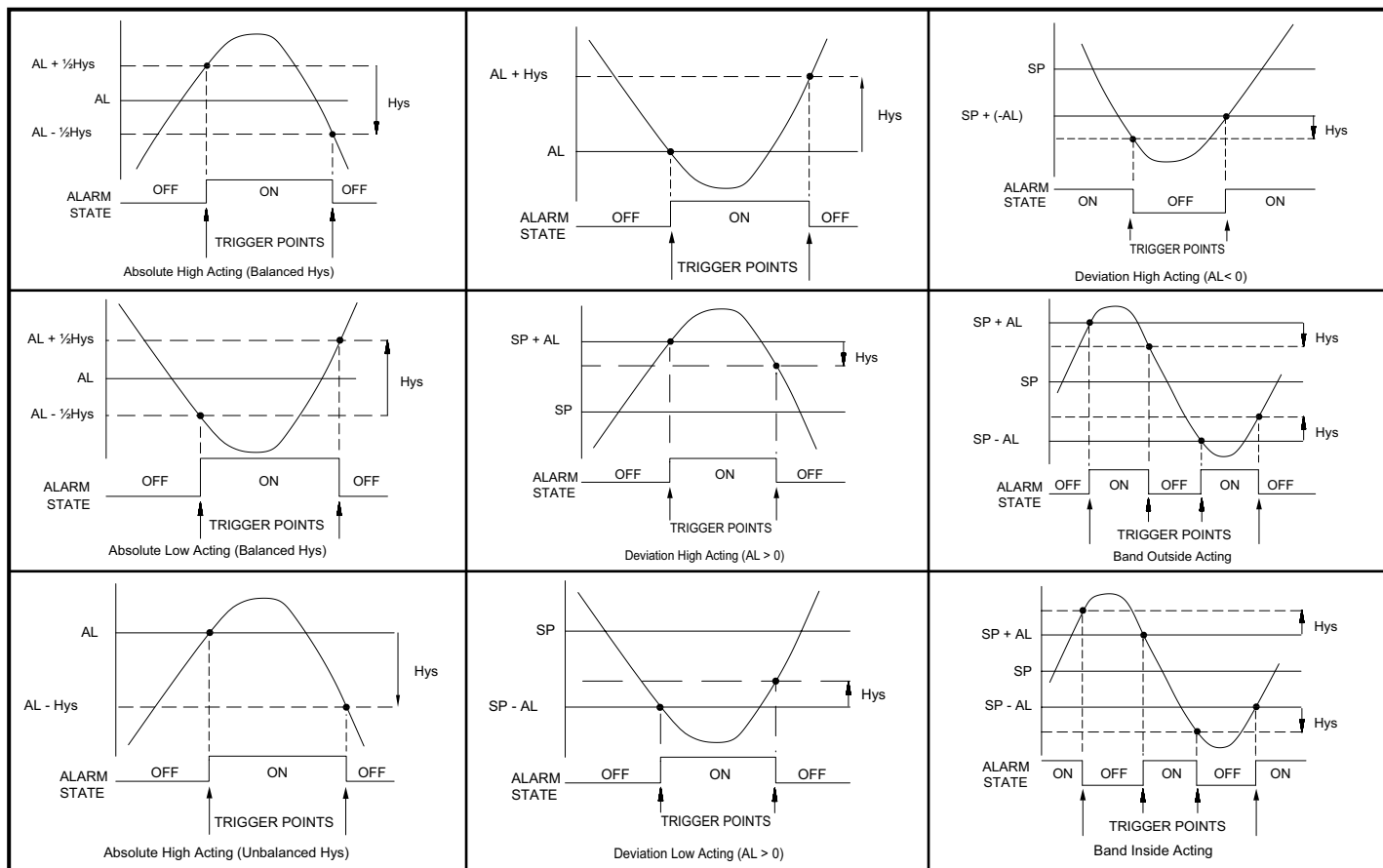

Note: Hys in the above figures refers to the Alarm Hysteresis.

Value (40003/40019), (40004/40020): The alarm values are entered as process units or degrees.

Hysteresis (40134/40234), (40139/40239): The Hysteresis Value is either added to or subtracted from the alarm value, depending on the alarm action selected. See the Alarm Action Figures for a visual explanation of how alarm actions are affected by the hysteresis.

Trigger Points: Trigger points are the Process Values where the alarm state changes. Their values cannot be entered directly, but are shown as a reference in the SFDLC software. The alarm value, hysteresis value, and setpoint alarm type determine the trigger points. With Deviation or Band actions, the alarm value and setpoint value are combined to determine the trigger points. Trigger points must not be greater than +32000 or less than -32000. If these limits are exceeded, the alarm may not function properly.

Reset (40132/40232), (40137/40237): The alarms can be programmed for Automatic or Latched. In Automatic mode, an energized alarm turns off automatically once the Process Value leaves the alarm region. In Latched mode, an energized alarm requires a manual reset. This is done by writing '0' to the appropriate output status register. After writing '0', the Automatic or Latched alarm will not turn on again until after the Process Value first returns to the alarm off region. Only alarms configured for Manual action can be energized by writing a '1' to its' alarm output status register.

On Delay (40135/40235), (40140/40240): The time, in seconds, required for the Process Value to be in the alarm region before the alarm will activate. It is used to allow temporary or short excursions into the alarm region without tripping the alarm.

Enable Standby Delay (40133/40233), (40138/40238): Standby prevents nuisance (typically low level) alarms after a power up or setpoint change. After powering up the controller or changing the setpoint, the process must leave the alarm region. Once this has occurred, the standby is disabled and the alarm responds normally until the next controller power up or setpoint change.

STEP 14 PROGRAMMING THE COOLING

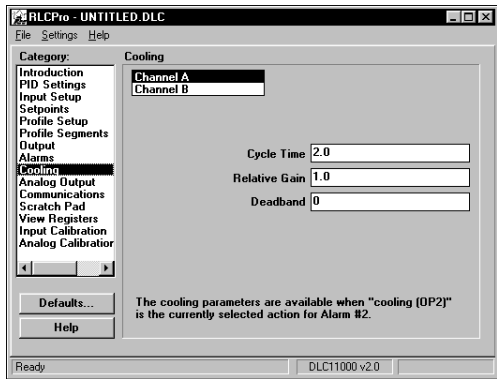

To enable Cooling in Heat/Cool applications, the Alarm 2 Action must first be set for Cooling. When set to cooling, the output no longer operates as an alarm but operates as an independent cooling output. The OP2 terminals are the same as AL2. Cooling output power ranges from -100% (full cooling) to 0% (no cooling, unless a heat/cool deadband overlap is used). The Power Limits in the Output category also limits the cooling power.

Cycle Time (40141/40241): This cycle time functions like the OP1 Output Cycle Time but allows independent cycle time for cooling. A setting of zero will keep output OP2 off. The status of OP2 can be read through registers (40016/40032).

Relative Gain (40142/40242): This defines the gain of the cooling relative to the heating. It is generally set to balance the effects of cooling to that of heating. This is illustrated in the Heat/Cool Relative Gain Figures. A value of 0.0 places the cooling output into On/Off Control. This may be done independent of the OP1 Output PID or On/Off Control Modes.

Deadband (40143/40243): This defines the area in which both heating and cooling are active (negative value) or the deadband area between the bands (positive value). If a heat/cool overlap is specified, the percent output power is the sum of the heat power (OP1) and the cool power (OP2). If Relative Gain is zero, the cooling output operates in the On/Off Control Mode, with the Deadband value becoming the cooling output hysteresis (positive value only). This is illustrated in the On/Off Control Mode section. For most applications, set this parameter to 0.0 prior to starting Auto-Tune. After the completion of Auto-Tune, this parameter may be changed.

HEAT/COOL RELATIVE GAIN FIGURES

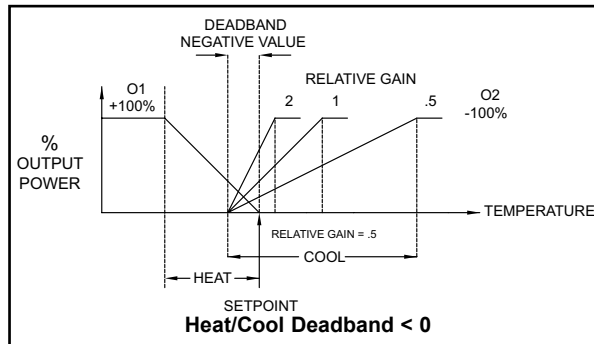
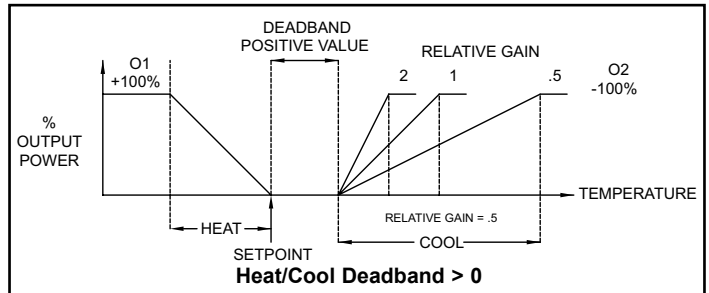
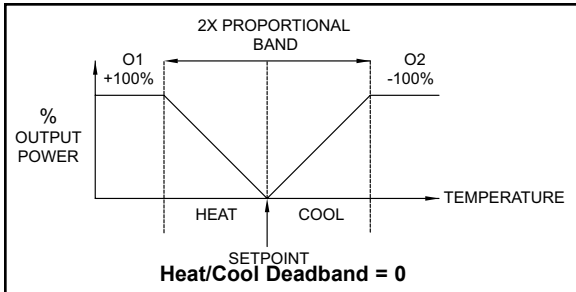

STEP 15 PROGRAMMING THE ANALOG OUTPUT (Optional)

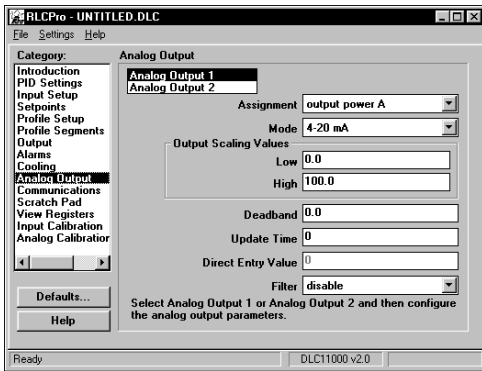

Note: The register numbers correspond to (Analog Output 1/Output 2).

Assignment (40301/40309): This setting selects the value that the Analog Output will retransmit, or track. The Analog output can be assigned for the following:

SELECTION	DESCRIPTION
Output Power A	Transmits the Output Power demand of Channel A. Used if linear control is desired.
Process Value A	Retransmits Process Value Channel A
Setpoint A	Retransmits Setpoint Value Channel A
Ramping Setpoint A	Retransmits Ramping Setpoint Channel A
Deviation A	Retransmits Deviation (difference of Setpoint Value - Process Value) Channel A
Direct Entry Value 1	Retransmits Direct Entry Value 1 (Manual Analog Control)
Output Power B	Transmits the Output Power demand of Channel B. Used if linear control is desired.
Process Value B	Retransmits Process Value Channel B
Setpoint B	Retransmits Setpoint Value Channel B
Ramping Setpoint B	Retransmits Ramping Setpoint Channel B
Deviation B	Retransmits Deviation (difference of Setpoint Value - Process Value) Channel B
Direct Entry Value 2	Retransmits Direct Entry Value 2 (Manual Analog Control)

Mode (40302/40310): Select the type of output and range. The Analog output jumpers must be set to match the output type and range selected. The Analog output can be calibrated to provide up to 5% of over range operation.

Output Scaling Values: The Scaling Low value (40303/40311) corresponds to 0 V, 0 mA or 4 mA, depending on the range selected. The Scaling High value (40304/40312) corresponds to 10 V or 20 mA depending on the range selected. An inverse acting output can be achieved by reversing the Scaling Low and Scaling High points.

Deadband (40305/40313): The output power change must be greater than the deadband value in order for the Analog output to update. This only applies when the Analog Output is assigned to Output Power. This setting can be used to reduce actuator activity.

Update Time (40306/40314): To reduce excess valve actuator or pen recorder activity, the update time of the analog output can be set in seconds. A value of zero seconds results in an update time of 0.1 second.

Direct Entry Value (40307/40315): If the analog output is programmed for Direct Entry, it retransmits this value. This value may be controlled by the host.

Filter (40308-40316): Entering a 1 will apply averaging when the Update Time ≥ 1 .

STEP 16 PROGRAMMING THE DLC COMMS PORT

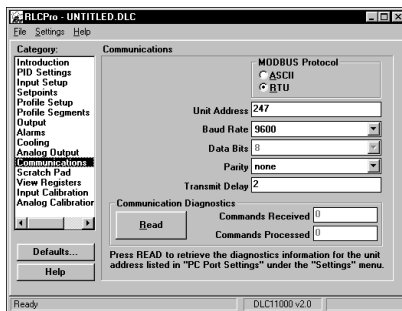

Note: If the software selectable communication settings are changed and then a download is performed, the controller will immediately respond to the new settings. Any further attempts to communicate to the controller must target the new address, with the new settings.

SERIAL SETTINGS

MODBUS Protocol (40405): RTU or ASCII

Unit Address (40401): 1-247

Baud Rate (40402): 300 to 38400

Data Bits (40404): 7 or 8

Parity (40403): odd, even, or none

Transmit Delay (40406): Programmable from 2-250 milliseconds.

The Transmit Delay is the time the DLC waits to respond to a serial command, UNLESS the values in the table are larger.

Note: Changing the above parameters by writing to their registers directly will not update the DLC until Load Serial Settings register 40407 is a '1'. After a write, this register will return to '0'.

DIP Switch Serial Settings: The DIP switches can be used to select the baud rate, parity, and unit address. When using the DIP switches to configure the serial settings, the Modbus communications mode will be RTU only. There is also a "Default Serial Settings" switch to quickly configure the DLC for use with the "RLCPro" Programming Software.

Software Selectable Serial Settings: Setting all of the DIP switches to the "off" position and having the "Default Serial Setting" terminal un-connected, enables Software Selectable Serial settings. When leaving the factory the Software Selectable serial settings are set to the Serial Communication Defaults. Software Selectable Serial Settings allows set-up of all serial settings including the choice of RTU or ASCII communications modes and the number of data bits. If the Software Selectable Serial Settings are changed, the load serial register must be used or power to the DLC must be removed and re-applied in order for the settings to take effect. The use of RLCPro Programming software or another software program supporting Modbus protocol is required to write to the DLC serial settings registers (40401-40407).

MINIMUM TRANSMIT DELAY		
BAUD	RTU	ASCII
38400	2 msec	2 msec
19200	3 msec	2 msec
9600	5 msec	2.3 msec
4800	9 msec	4.6 msec
2400	17 msec	9.2 msec
1200	33 msec	18.4 msec
600	65 msec	36.7 msec
300	129 msec	73.4 msec

Default Serial Settings: The DLC serial port can be temporarily set to the factory defaults by setting the Default serial communications DIP switch to the “up” position OR by placing a jumper from the “Default Serial Setting” terminal 7 (TBB) to Output common terminal 4 (TBA). Both of these have precedence over the DIP switch serial settings and the software selectable serial settings. Once the serial default DIP switch is set to the “off” position or the jumper is removed, the DLC serial settings will immediately change as programmed by the DIP switches or the software selectable serial settings if all of the DIP switches are in the “off” position. The Default Serial Settings are NOT loaded into the software selectable serial registers when the serial default setting switch/terminal is active, they must be explicitly changed.

Serial Communication Defaults: 9600 baud, 1 start bit, no Parity, 1 stop bit, address 247, and RTU mode.

Communications Diagnostics: The Communications Diagnostics function (MODBUS Function Code 08) can be used to troubleshoot systems that are experiencing communication errors. Press the Read button to retrieve the diagnostics information. The Commands Received and the Commands Processed values are automatically reset when the values are read, at each controller power-up, and when the Commands Received reaches 65536.

Commands Received: The total number of messages received that started with the controller’s own address since the last reset or power up.

Commands Processed: The number of “good” messages received. A “good” message is considered one that contained the correct unit address, parity, and checksum (CRC or LRC).

STEP 17 PC PORT CONFIGURATION



Go to the SETTINGS pull-down menu, and select PC PORT SETTINGS.

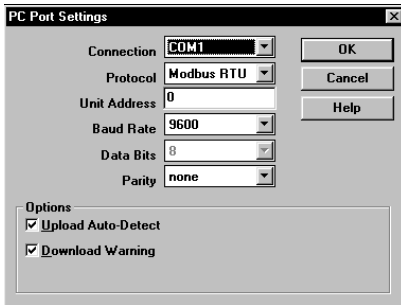

The Communications Settings window allows you to set up the software properly to perform a download.

Connection: Select the computer port (COMM 1-4) that the DLC is connected to.

Note: The following settings must match the DLC. If you do not know or cannot recall the DLC settings, they can be temporarily set to factory defaults. Simply jumper the Default Serial Setting terminal 7 to Input Common terminal 4 or put the Default Serial Settings DIP switch in the “UP” position. The serial settings will default to RTU mode, 9600 baud, 8 data bits, no parity, with an address of 247.

Protocol: RTU or ASCII

Unit Address: 1-247

Baud Rate: 300, 600, 1200, 2400, 4800, 9600, 19200, 38400

Data Bits: 7 or 8

Parity: odd, even, or none

Connect the DLC to the computer with the CBPRO007 interface cable (or any suitable RS232/RS485 converter). Apply power to the supply terminals of the DLC.

Note: The CBPRO007 download cable DOES NOT typically require power. In most cases it will derive its power from the PC. If communications can not be established, follow the troubleshooting guide. If it is determined that the converter requires power, attach a 12 VDC power supply to the VDC and common terminals of the cable.

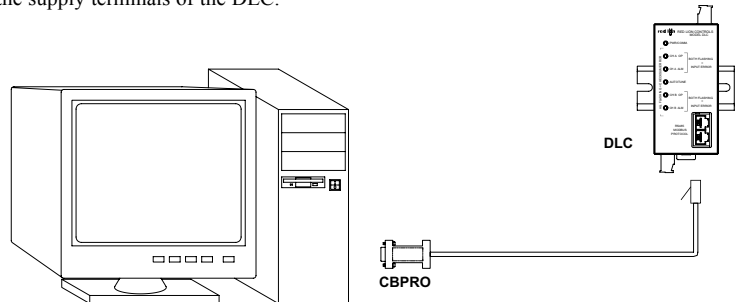

STEP 18 DOWNLOADING

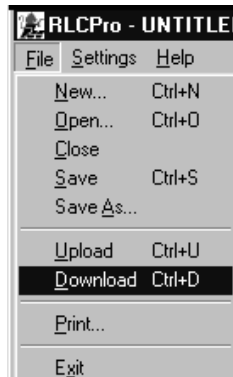

Go to the FILE pull-down menu, and select DOWNLOAD.

The following screen prompts you to ensure that the proper file is downloaded to the correct controller. Click “OK” to continue.

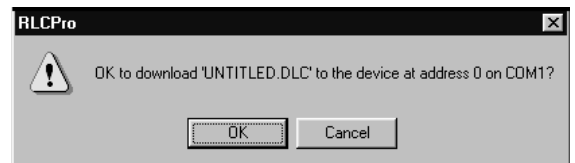

STEP 19 SCRATCH PAD MEMORY

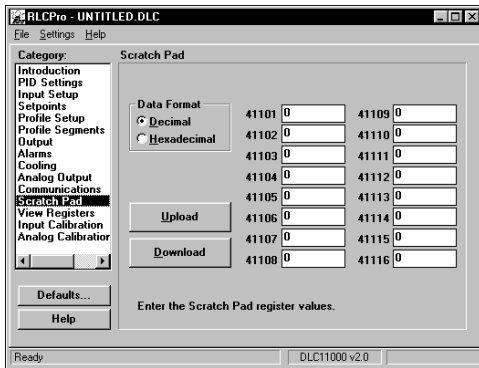

The Scratch Pad category can be used to read or write to the Scratch Pad memory locations (41101-41116). The Scratch Pad locations can be used to store user information.

Data Format: Allows registers to be viewed in decimal or hexadecimal format.

Upload: The Upload button causes SFDLC software to read the Scratch Pad registers from the controller.

Download: The Download button causes SFDLC software to write to the Scratch Pad registers in the controller.

Note: Downloading new values to the controller Scratch Pad locations overwrites the information that is currently stored in those registers.

Defaults: For this category, there are no controller factory defaults. The defaults for this category are only SFDLC software basic default values.

STEP 20 VIEW REGISTERS

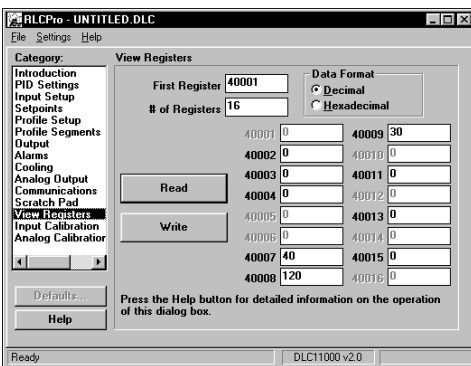

The View Registers category can be used as a method of diagnostics. Use the DLC Register Table as a reference of register assignments and data.

First Register: This specifies the first register to be read in a block.

of Registers: This is the length of the block to be read. The controller supports block read and write commands up to 32 registers in length. The SFDLC software only allows 16 to be read in a block.

Data Format: Allows registers to be viewed in decimal or hexadecimal format.

Read: Clicking the Read button causes SFDLC software to read the selected registers from the controller.

Write: Clicking the Write button causes SFDLC software to write the selected registers to the controller.
Note: The Write button overwrites the existing register values, and may change the module setup and operation.

Defaults: For this category, there are no controller factory defaults. By clicking Defaults, the present entries from the other SFDLC software category screens will be displayed.

STEP 21 CALIBRATION

The DLC is fully calibrated from the factory. Recalibration is recommended every two years. Each channel is calibrated separately. All calibration settings are stored in the non-volatile memory. Calibration may be performed by using SFDLC software or MODBUS commands. When using SFDLC for calibration, connect the signal or measuring source to the proper DLC terminals, verify the input or output jumper positions, select the type of calibration to be performed, and click the Calibrate button. Follow the calibration procedures in the software.

Note: Allow the DLC to warm up for 30 minutes minimum and follow the manufacturer's warm-up recommendations for the calibration source.

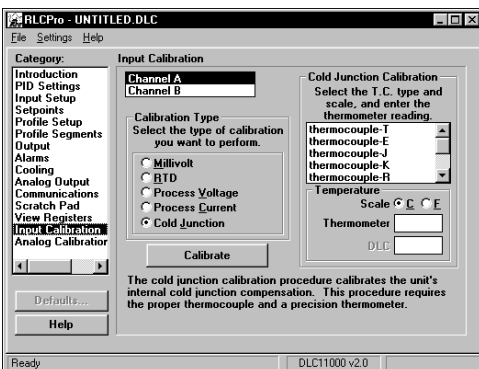

INPUT CALIBRATION

When calibrating the input, the millivolt calibration must be performed first. All other input types use the millivolt points. Each input range (non-thermocouple) also has its own internal references that are recalled when the range is selected. Non-used types need not be calibrated.

Calibration Type: This specifies the type of calibration to be performed.

Millivolt: Millivolt calibration requires a precision voltage source with an accuracy of 0.03% or better. It is used for thermocouple inputs and as a basis for all other input calibration types.

RTD: RTD calibration requires a 0.1% (or better) precision 277.0 ohm resistor.

Process Voltage: Process calibration requires a precision signal source with an accuracy of 0.03% (or better) that is capable of generating 10.00 V.

Process Current: Process current calibration requires a precision signal source with an accuracy of 0.03% (or better) that is capable of generating 20.00 mA.

Cold Junction: Cold Junction calibration requires a thermocouple of known accuracy of types T, E, J, K, C or N only and a calibrated external reference thermocouple probe.

TC Type: This selects the type of TC that is being used to calibrate the cold junction.

Scale: This selects the scale in which the Thermometer temperature is entered and the controller temperature is displayed.

Thermometer: Enter the reference thermometer temperature here.

DLC: This displays the DLC process temperature value after a cold junction calibration is completed to verify the accuracy.

Calibrate: The Calibrate button initiates the calibration process after the appropriate settings are selected.

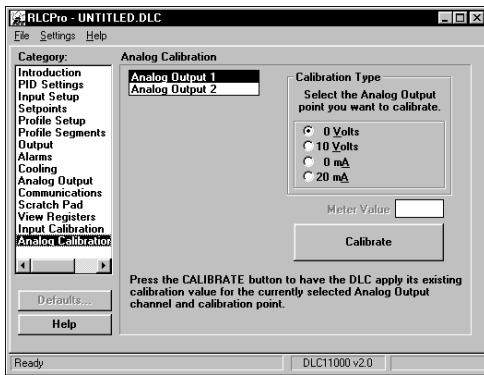

ANALOG OUTPUT CALIBRATION

Calibration Type: This specifies the Analog Output point to be calibrated.

Volts: Analog Output Voltage calibration requires a precision meter with an accuracy of 0.05% (or better) that is capable of measuring 10.00 V.

mA: Analog Output Current calibration requires a precision meter with an accuracy of 0.05% (or better) that is capable of measuring 20.00 mA.

Meter Value: After pressing the Calibrate button, this shows the value the DLC is outputting. Measure the actual output with an external meter and enter that value here. Press the Calibrate button again and follow the prompts.

Calibrate: The Calibrate button initiates the calibration process after the appropriate settings are selected.

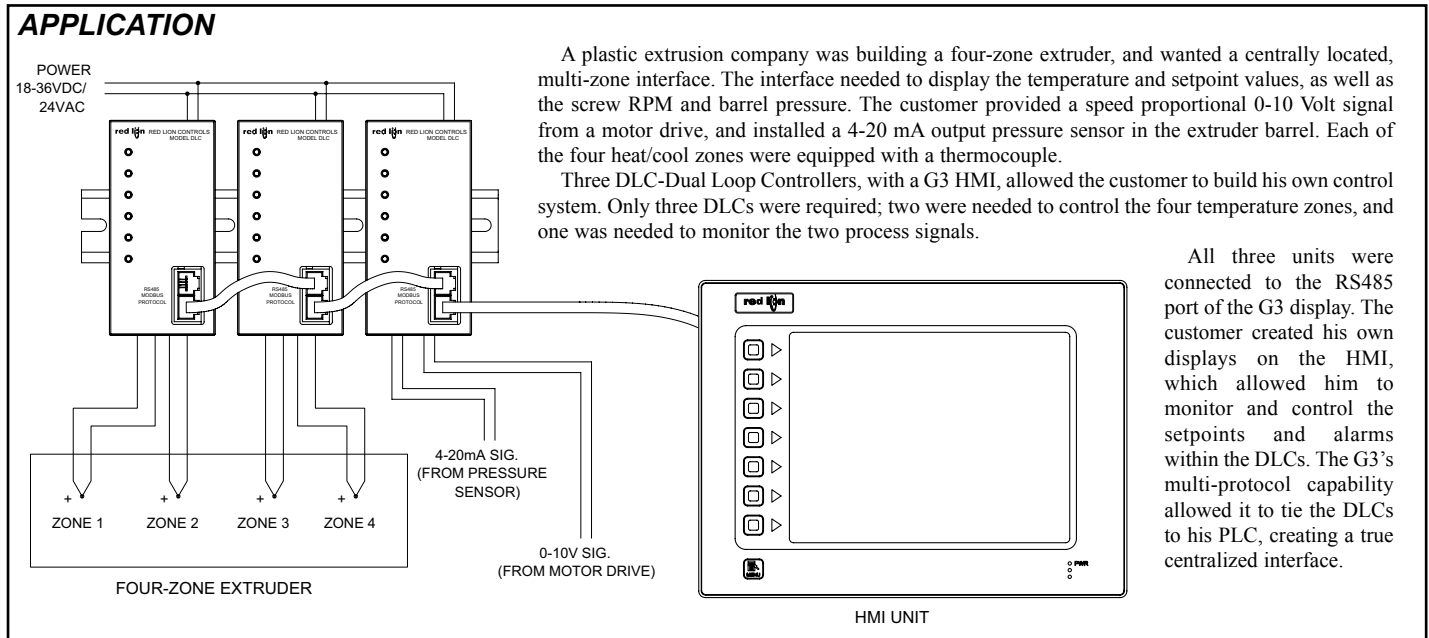

CONTROL MODE EXPLANATIONS

MANUAL CONTROL MODE

In Manual Control Mode, the controller operates as an open loop system (does not use the setpoint and process feedback). The user enters a percentage of power through the Output Power register (40005/40021) to control the heat (reverse) or cool (direct) for Output OP1. When Alarm 2 is configured for Cooling (OP2), Manual operation provides 0 to 100% power to OP1 (heating) and -100 to 0% power to OP2 (Cooling). The Low and High Power limits are ignored when the controller is in Manual.

For time proportional outputs, the output power is converted into output On time using the Cycle Time. For example, with a four second cycle time and 75% power, the output will be on (4×0.75) for three seconds and off for one second. For Analog Outputs (0-10 VDC or 0/4-20 mA), the percent output power is converted into a linear value according to the Percent Low and High scaling set for the analog output. For example, with 0 VDC (scaled 0.0%) to 10 VDC (scaled 100%) and 75% power, the analog output will be 7.5 VDC.

MODE TRANSFER

When transferring the controller mode from or to Automatic, the controlling outputs remain constant, exercising true bumpless transfer. When transferring from Manual to Automatic, the power initially remains steady, but Integral Action corrects (if necessary) the closed loop power demand at a rate proportional to the Integral Time. The Control Mode can be changed through the Control Mode register (40041/40049).

AUTOMATIC CONTROL MODE

In Automatic Control Mode, the percentage of output power is automatically determined by PID or On/Off calculations based on the setpoint and process feedback. For this reason, PID Control and On/Off Control always imply Automatic Control Mode.

ON/OFF CONTROL

The controller operates in On/Off Control when the Proportional Band is set to 0.0%. In this control, the process will constantly oscillate around the setpoint value. The On/Off Control Hysteresis (balanced around the setpoint) can be used to eliminate output chatter. Output OP1 Control Action can be set to reverse for heating (output on when below the setpoint) or direct for cooling (output on when above the setpoint) applications.

ON/OFF CONTROL - REVERSE OR DIRECT ACTING FIGURES

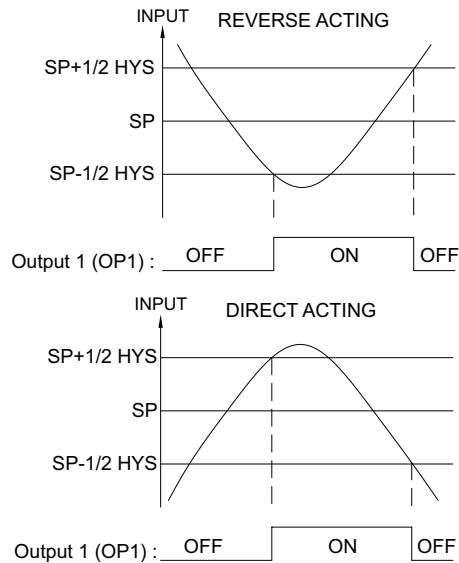

For heat and cool systems, OP1 Control Action is set to reverse (heat) and the Alarm 2 Action is set to cooling (OP2). The Proportional Band is set to 0.0 and the Relative Gain in Cooling to 0.0. The Deadband in Cooling sets the amount of operational deadband or overlap between the outputs. The setpoint and the On/Off Control Hysteresis applies to both OP1 and OP2 outputs. The hysteresis is balanced in relationship to the setpoint and deadband value.

Note: HYS in the On/Off Control Figures refers to the On/Off Control Hysteresis.

ON/OFF CONTROL - HEAT/COOL OUTPUT FIGURES

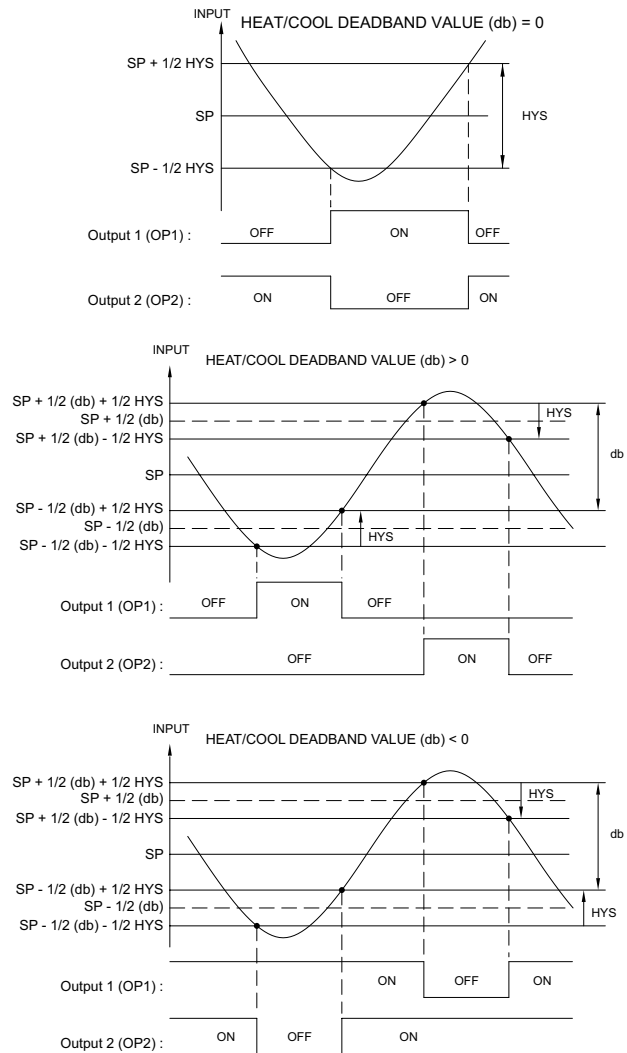

PID CONTROL

In PID Control, the controller processes the input and then calculates a control output power value by use of a modified Proportional Band, Integral Time, and Derivative Time control algorithm. The system is controlled with the new output power value to keep the process at the setpoint. The Control Action for PID Control can be set to reverse for heating (output on when below the setpoint) or direct for cooling (output on when above the setpoint) applications. For heat and cool systems, the heat (OP1) and cool (OP2) outputs can be used together in the PID Control. The PID parameters can be Auto-Tune or Manual Tune to the process.

TYPICAL PID RESPONSE CURVE

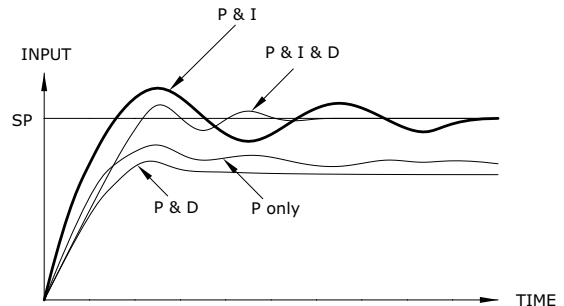

REMOTE SETPOINT

Channel B can operate as a Remote Setpoint Input to Channel A. Channel B PID control is not functional when the input is assigned as a Remote Setpoint. This mode of operation enables Cascade control (external), Ratio control, and Temperature Setpoint Slave control, among others.

The Remote Setpoint value used internally by the controller is:

$$\text{Remote Setpoint} = (\text{Scaled CHB Input} * \text{Remote Setpoint Ratio Multiplier}) + \text{Remote Setpoint Bias Offset}$$

where Ratio Multiplier = 0.0001 to 3.2000
Bias Offset = -32000 to 32000

The Ratio Multiplier and Bias Offset parameters offer on-line scaling of the Remote Setpoint to adjust control ratios or biases among related processes.

The Remote Setpoint is restricted to the setpoint low and high limit values for channel B. These parameters may be used to limit the range of the Remote Setpoint to a safe or more stable control range. For Remote Setpoint signal sources that change wildly or are too sensitive to process upsets, the CHA Setpoint Ramp Rate parameter (40110) can be used to ramp (rate limit) the Remote Setpoint reading. This can subsequently reduce the fluctuations of the secondary control loop.

PID TUNING EXPLANATIONS

AUTO-TUNE

Auto-Tune is a user-initiated function where the controller automatically determines the Proportional Band, Integral Time, Derivative Time, Digital Filter, Control Output Dampening Time, and Relative Gain (Heat/Cool) values based upon the process characteristics. The Auto-Tune operation cycles the controlling output(s) at a control point three-quarters of the distance between the present process value and the setpoint. The nature of these oscillations determines the settings for the controller's parameters.

Prior to initiating Auto-Tune, it is important that the controller and system be first tested. (This can be accomplished in On/Off Control or Manual Control Mode.) If there is a wiring, system or controller problem, Auto-Tune may give incorrect tuning or may never finish. Auto-Tune may be initiated at start-up, from setpoint or at any other process point. However, insure normal process conditions (example: minimize unusual external load disturbances) as they will have an effect on the PID calculations. Auto-Tune cannot be initiated while running a profile.

Start Auto-Tune

1. Enter the On/Off Control Hysteresis value.
(For most applications, 10 is a suggested value.)
2. Enter the Deadband value, if using OP2.
(For most applications, 0 is a suggested value.)
3. Enter the Setpoint value.
(If Auto-Tune overshoot is unacceptable, then lower the value and restart.)
4. Enter the Auto-Tune Code. (See Figure for details)
5. Enter '1' in the Auto-Tune Start register. (Channel A 40011/Channel B 40027).
6. The Auto-Tune LED will come on.

Auto-Tune Progress

The controller will oscillate the controlling output(s) for four cycles. The cycling phase can be monitored from the Auto-Tune Phase Register (Channel A 40012/Channel B 40028). The time to complete the Auto-Tune cycles is process dependent. The controller should automatically stop Auto-Tune and store the calculated values when the four cycles are complete. If the controller remains in Auto-Tune unusually long, there may be a process problem. Auto-Tune may be stopped by entering '0' in Auto-Tune Start Register (Channel A 40011/Channel B 40027).

AUTO-TUNE CODE FIGURE

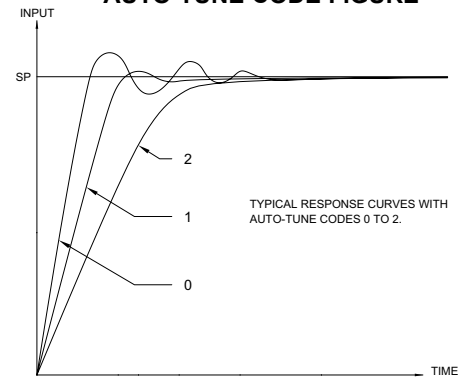

AUTO-TUNE OPERATION (REVERSE ACTING)

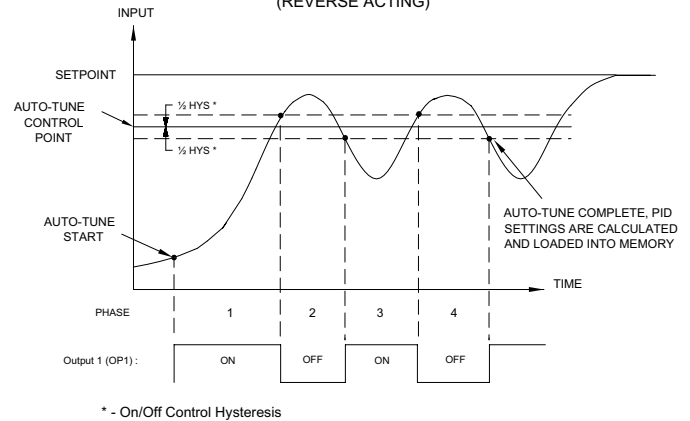

PID Adjustments

In some applications, it may be necessary to fine tune the Auto-Tune calculated PID parameters. To do this, a chart recorder or data logging device is needed to provide a visual means of analyzing the process. Compare the actual process response to the PID response figures with a step change to the process. Make changes to the PID parameters in no more than 20% increments from the

starting value and allow the process sufficient time to stabilize before evaluating the effects of the new parameter settings.

In some unusual cases, the Auto-Tune function may not yield acceptable control results or induced oscillations may cause system problems. In these applications, Manual Tuning is an alternative.

PROCESS RESPONSE EXTREMES

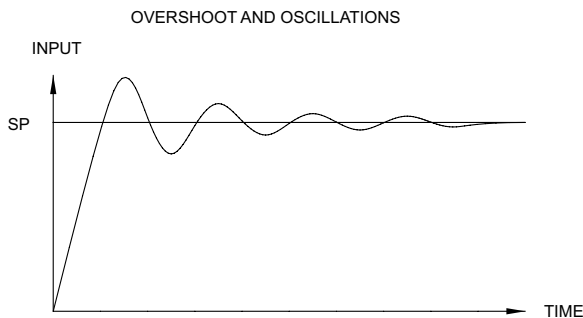

- TO DAMPEN RESPONSE:**
- INCREASE PROPORTIONAL BAND.
 - INCREASE INTEGRAL TIME.
 - USE SETPOINT RAMPING.
 - USE OUTPUT POWER LIMITS.
 - RE-INVOKe AUTO-TUNE WITH A HIGHER AUTO-TUNE CODE.
 - INCREASE DERIVATIVE TIME.
 - CHECK CYCLE TIME.

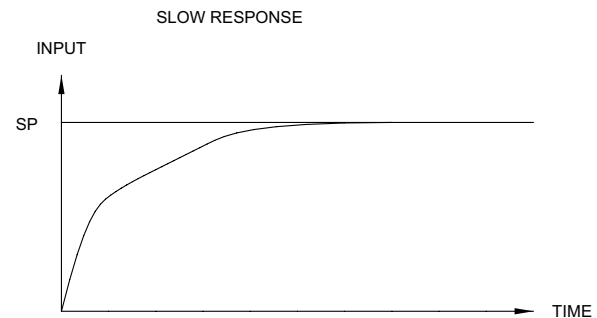

- TO QUICKEN RESPONSE:**
- DECREASE PROPORTIONAL BAND.
 - DECREASE INTEGRAL TIME.
 - INCREASE OR DEFEAT SETPOINT RAMPING.
 - EXTEND OUTPUT POWER LIMITS.
 - RE-INVOKe AUTO-TUNE WITH A LOWER AUTO-TUNE CODE.
 - DECREASE DERIVATIVE TIME.

MANUAL TUNING

A chart recorder or data logging device is necessary to measure the time between process cycles. This procedure is an alternative to the controller's Auto-Tune function. It will not provide acceptable results if system problems exist. This procedure should be performed by directly accessing the controller's registers. The register numbers correspond to (Channel A/Channel B).

1. Set the Proportional Band (40007/40023) to 10.0% for temperature inputs and 100.0% for process inputs.
2. Set both the Integral Time (40008/40024) and Derivative Time (40009/40025) to 0 seconds.
3. Set the Output Dampening Time (40121/40221) to 0 seconds.
4. Set the Output Cycle Time (40116/40216) to no higher than one-tenth of the process time constant (when applicable).
5. Place the controller in Manual Control Mode (40041/40049) and adjust the

Output Power (40005/40021) to drive the process value to the Setpoint value.

Allow the process to stabilize after setting the Output Power.

6. Place the controller in Automatic Control Mode (40041/40049). If the process will not stabilize and starts to oscillate, set the Proportional Band two times higher and go back to Step 5.
7. If the process is stable, decrease Proportional Band setting by two times and change the setpoint value a small amount to excite the process. Continue with this step until the process oscillates in a continuous nature.
8. Fix the Proportional Band to three times the setting that caused the oscillation in Step 7.
9. Set the Integral Time to two times the period of the oscillation.
10. Set the Derivative Time to one-eighth (0.125) of the Integral Time.
11. Set the Output Dampening Time to one-fortieth (0.025) the period of the oscillation.

MODBUS INFORMATION

The remaining sections of this bulletin list information for MODBUS conformity with DLC registers and coils data.

MODBUS SUPPORTED FUNCTION CODES

FC01: Read Coils

1. Valid coil addresses are 1-33.
2. All coils can be requested.
3. Block starting point can not exceed coil 33.

FC05: Force Single Coil

1. Valid write (force) coil addresses are 1-4, 10-13, 15-16, 22-25, 27-33.
2. HEX <8001> is echoed back for a request to write to a read only coil, to indicate that the coil did not change.

FC15: Force Multiple Coils

1. Valid write (force) coil addresses are 1-4, 10-13, 15-16, 22-25, 27-33.
2. Block starting point can not exceed coil 33.
3. If a multiple write includes read only coils, then only the write coils will change.

FC03: Read Holding Registers

1. Valid register addresses are 40001-40032, 40041-40046, 40049-40053, 40065-40070, 40073-40078, 40100-40122, 40131-40143, 40198-40222, 40231-40243, 40301-40308, 40309-40316, 40321-40327, 40401-40407, 40421-40427, 40501-40505, 40601-40660, 40701-40760, 41001-41010, 41101-41116.
2. Up to 32 registers can be requested at one time.
3. Block starting point can not exceed the register boundaries.
4. HEX <8000> is returned in registers beyond the boundaries.
5. Holding registers are a mirror of Input registers.

FC06: Preset Single Register

1. Valid write (preset) register addresses are 40002-40005, 40007-40011, 40013, 40015-40016, 40018-40021, 40023-40027, 40029, 40031-40032, 40041-40042, 40044, 40046, 40049-40050, 40052-40053, 40065, 40068-40070, 40073, 40076-40078, 40100-40122, 40131-40143, 40198-40222, 40231-40243, 40301-40316, 40321-40327, 40401-40407, 40421-40427, 40501-40505, 40601-40660, 40701-40760, 41101-41116.
2. HEX <8001> is echoed back that the register did not change during the request to write to a read only register.
3. If the write value exceeds the register limit (see Register Table), then that register value changes to its high or low limit. It is also returned in the response.

FC16: Preset Multiple Registers

1. Valid write (preset) register addresses are 40002-40005, 40007-40011, 40013, 40015-40016, 40018-40021, 40023-40027, 40029, 40031-40032, 40041-40042, 40044, 40046, 40049-40050, 40052-40053, 40065, 40068-40070, 40073, 40076-40078, 40100-40122, 40131-40143, 40198-40222, 40231-40243, 40301-40316, 40321-40327, 40401-40407, 40421-40427, 40501-40505, 40601-40660, 40701-40760, 41101-41116.
2. No response is given with an attempt to write to more than 32 registers at a time.
3. Block starting point can not exceed the read and write boundaries.
4. If a multiple write includes read only registers, then only the write registers will change.
5. If the write value exceeds the register limit (see Register Table), then that register value changes to its high or low limit.

FC04: Read Input Registers

1. Valid register addresses are 30001-30032, 30041-30046, 30049-30053, 30065-30070, 30073-30078, 30100-30122, 30131-30143, 30198-30222, 30231-30243, 30301-30308, 30309-30316, 30321-30327, 30401-30407, 30421-30427, 30501-30505, 30601-30660, 30701-30760, 31001-31010, 31101-31116.
2. Up to 32 registers can be requested at one time.
3. Block starting point can not exceed register boundaries.
4. HEX <8000> is returned in registers beyond the boundaries.
5. Input registers are a mirror of Holding registers.

FC08: Diagnostics

The following is sent upon FC08 request:

Module Address, 08 (FC code), 04 (byte count), "Total Comms" count, "Total Good Comms" count, checksum of the string

"Total Comms" is the total number of messages received that were addressed to the DLC. "Total Good Comms" is the total messages received by the DLC with good address, parity and checksum. Both counters are reset to 0 upon response to FC08, on power-up, and when Total Comms register rolls over.

FC17: Report Slave ID

The following is sent upon FC17 request:

Unit Address, 17 (FC code), RLC-DLCxx000 (model number), 0200 (for code version 2.00), 32 (number of read supported registers), 32 (number of writes supported registers), 16 (number of registers available for GUID/Scratch pad memory), checksum of the string.

SUPPORTED EXCEPTION CODES

01: Illegal Function

Issued whenever the requested function is not implemented in the controller.

02: Illegal Data Address

Issued whenever an attempt is made to access a single register or coil that does not exist (outside the implemented space) or to access a block of registers or coils that falls completely outside the implemented space.

03: Illegal Data Value

Issued when an attempt is made to read or write more registers or coils than the controller can handle in one request.

07: Negative Acknowledge

Issued when a write to coil or register is attempted with an invalid string length.

CHECKSUM ERRORS

1. Calibration checksum covers the area that contains calibration values for all ranges. When a calibration checksum error occurs, coil 1 becomes a "1".
2. Parameter checksum covers the area that contains the stored Holding register settings. When this checksum error occurs, coil 2 becomes a "1".
3. Integral and Offset/Manual Power checksum covers the area that contains the stored Integral register settings. When this checksum error occurs, coil 3 becomes a "1".
4. Setpoint Controller Segment Memory checksum covers the memory area that contains the profile segments for channel A and B. When this checksum error occurs, coil 29 becomes a "1".
5. Setpoint Controller Status Memory checksum covers the memory area that contains the profile operating status. When this checksum error occurs, coil 30 becomes a "1" and aborts the profile putting channel in manual control at 0% power.
6. All LEDs except PWR/COMMS will flash as long as one of the errors exist.
7. The control and alarm outputs are disabled as long as one of the errors exist.
8. These errors can be cleared or activated manually by writing to the appropriate coil. (This does not correct the reason for the error. It may be necessary to reconfigure or calibrate.)
9. The checksums are verified at power up.

CALIBRATION USING MODBUS COMMANDS

The DLC is fully calibrated from the factory. Recalibration is recommended every two years. Each channel is calibrated separately. All calibration settings are stored in the non-volatile memory. The DLC may be calibrated using MODBUS. However, the preferred method of calibrating the controller is through the SFDLC software.

When calibrating the input, a successful millivolt calibration must be performed first. All other input types use the millivolt points. Each input range (non-thermocouple) also has its own internal references that are recalled when the range is selected. Non-used types need not be calibrated.

Each of the procedures below show the calibration steps/register numbers for both channels A & B, however, only one channel can be calibrated at a time.

Note: Allow the DLC to warm up for 30 minutes minimum and follow the manufacturer's warm-up recommendations for the calibration or measuring source.

mV Calibration

Millivolt calibration requires a precision signal source with an accuracy of 0.03% (or better) that is capable of generating the range to be calibrated. It is used for thermocouple inputs and as a basis for all other input calibration types.

1. Connect the signal source to the proper DLC terminals.
2. Enter 13 (for mV input) into register 40101 (Ch A) or 40201 (Ch B).
3. To open calibration mode, enter 48 into register 40501.
4. To start mV calibration, enter 1 (Ch A) or 101 (Ch B) into register 40501.
5. Apply the appropriate calibration voltage for a minimum of 10 seconds.
6. To store the mV calibration reading, enter the corresponding range number into register 40501:

RANGE	Ch A	Ch B
0 mV	2	102
14 mV	3	103
28 mV	4	104
42 mV	5	105
56 mV	6	106

7. Repeat steps 5 and 6 for each range to be calibrated for that channel.
8. To save the calibration results and end calibration, enter 0 into register 40501.

Cold Junction Calibration *

Cold Junction calibration requires a thermocouple of known accuracy of types T, E, J, K, C or N only and a calibrated external reference thermocouple probe.

1. Connect the thermocouple probe source to the proper DLC terminals.
2. Enter the connected thermocouple type into register 40101 (Ch A) or 40201 (Ch B).
3. Enter the scale (F or C) that matches the thermometer and the controller temperature, preferably °C into register 40102 (Ch A) or 40202 (Ch B).
4. Enter 1 for high resolution into register 40103 (Ch A) or 40203 (Ch B).
5. Place an external reference thermometer probe at the end of the DLC probe. The two probes should be shielded from air movement and allowed sufficient time to equalize in temperature. (As an alternative, the DLC probe may be placed in a calibration bath of known temperature.)
6. To open calibration mode, enter 48 into register 40501.
7. To start CJ calibration, enter 10 (Ch A) or 110 (Ch B) into register 40501.
8. Read the Process Value register 40001 (Ch A) or 40017 (Ch B).
9. Subtract the external reference reading from the Process Value register reading. Adjust the results to tenths position, drop decimal point, and maintain the results sign. (If the difference is -2 degrees, then adjust to -2.0 and remove decimal point yielding a value of -20.)
10. Add the value from step 9 (maintain the sign) to the value existing in register 40502.
11. If necessary, continue to adjust the register 40502 value until the Process Value register 40001 (Ch A) or 40017 (Ch B) matches the external reference reading.
12. To exit CJ calibration, enter 11 (Ch A) or 111 (Ch B) into register 40501.
13. To save the calibration results and close calibration mode, enter 0 into register 40501.

RTD Calibration *

RTD calibration requires a 0.1% (or better) precision 277.0 ohm resistor.

1. Connect a precision 277.0 ohm resistor, and a short, to terminals 1 & 2 (Ch B) or 4 & 5 (Ch A). During the complete procedure, short terminals 2 & 3 (Ch B) or 5 & 6 (Ch A).
2. Verify the input jumper is in the RTD position.
3. Enter 12 (ohms mode) into register 40101 (Ch A) or 40201 (Ch B).
4. To open calibration mode, enter 48 into register 40501.
5. To start RTD calibration, enter 20 (Ch A) or 120 (Ch B) into register 40501.
6. Leave 0 ohms (short) on terminals 1 & 2 (Ch B) or 4 & 5 (Ch A) for 10 seconds.
7. To store 0 ohm results, enter 21 (Ch A) or 121 (Ch B) into register 40501.
8. Apply 277 ohms by removing the short from terminal 1 & 2 (Ch B) or 4 & 5 (Ch A) for 10 seconds.
9. To store 277 ohm results, enter 22 (Ch A) or 122 (Ch B) into register 40501.
10. To save the calibration results and close calibration mode, enter 0 into register 40501.

Process Voltage Calibration *

Process calibration requires a precision signal source with an accuracy of 0.03% (or better) that is capable of generating 10.00 V.

1. Connect the signal source to the proper DLC terminals.
2. Verify the input jumper is in the 10 V position.
3. Enter 14 (for voltage input) into register 40101 (Ch A) or 40201 (Ch B).
4. To open calibration mode, enter 48 into register 40501.
5. To start voltage calibration, enter 12 (Ch A) or 112 (Ch B) into register 40501.
6. Apply 0.00 V for a minimum of 10 seconds.
7. To store 0.00 V reading, enter 13 (Ch A) or 113 (Ch B) into register 40501.
8. Apply 10.00 V for a minimum of 10 seconds.
9. To store 10.00 V reading, enter 14 (Ch A) or 114 (Ch B) into register 40501.
10. To save the calibration results and close calibration mode, enter 0 into register 40501.

* - Dependent on successful mV calibration.

Process Current Calibration *

Process current calibration requires a precision signal source with an accuracy of 0.03% (or better) that is capable of generating 20.00 mA.

1. Connect the signal source to the proper DLC terminals.
2. Verify the input jumper is in the 20 mA position.
3. Enter 15 (for current input) into register 40101 (Ch A) or 40201 (Ch B).
4. To open calibration mode, enter 48 into register 40501.
5. To start current calibration, enter 15 (Ch A) or 115 (Ch B) into register 40501.
6. Apply 0.00 mA for a minimum of 10 seconds.
7. To store 0.00 mA reading, enter 16 (Ch A) or 116 (Ch B) into register 40501.
8. Apply 20.00 mA for a minimum of 10 seconds.
9. To store 20.00 mA reading, enter 17 (Ch A) or 117 (Ch B) into register 40501.
10. To save the calibration results and close calibration mode, enter 0 into register 40501.

Analog Output Voltage Calibration

Analog Output Voltage calibration requires a precision meter with an accuracy of 0.05% (or better) that is capable of measuring 10.00 V.

1. Connect the meter to the proper DLC terminals.
2. Verify the output jumpers are in the V positions.
3. To open calibration mode, enter 48 into register 40501.
4. To start 0 volt calibration, enter 30 (Out 1) or 130 (Out 2) into register 40501.
5. Adjust register 40502 value until the external meter displays 0.00 V.
6. To start 10 volt calibration, enter 31 (Out 1) or 131 (Out 2) into register 40501.
7. Adjust register 40502 value until the external meter displays 10.00 V.
8. To save the calibration results and close calibration mode, enter 0 into register 40501.

Analog Output Current Calibration

Analog Output Current calibration requires a precision meter with an accuracy of 0.05% (or better) that is capable of measuring 20.00 mA.

1. Connect the meter to the proper DLC terminals.
2. Verify the output jumpers are in the I position.
3. To open calibration mode, enter 48 into register 40501.
4. To start 0 mA calibration, enter 32 (Out 1) or 132 (Out 2) into register 40501.
5. Adjust register 40502 value until the external meter displays 0.00 mA.
6. To start 20 mA calibration, enter 33 (Out 1) or 133 (Out 2) into register 40501.
7. Adjust register 40502 value until the external meter displays 20.00 mA.
8. To save the calibration results and close calibration mode, enter 0 into register 40501.

Restore Factory Settings

The Factory Settings are listed in the DLC Register Table. This restore does not affect the calibration or communication settings of the DLC but may change all other settings for the channel.

1. To open calibration mode, enter 48 into register 40501.
2. To restore Factory Settings, enter 66 (Input Ch A and Analog Out 1) or 166 (Input Ch B and Analog Out 2) into register 40501.
3. To save the restore results and close calibration mode, enter 0 into register 40501.

Clear Setpoint Controller Segment Memory

1. To open calibration mode, enter 48 into register 40501.
2. To clear Setpoint Controller Segment memory, enter 67 (CHA Segment memory) or 167 (CHB Segment Memory) into register 40501.
3. To save the Clear results and close calibration mode, enter 0 into register 40501.

Nominal Calibration Settings

Nominal Calibration Settings does not require any calibration signals nor meters. This calibration should not be performed under normal circumstances.

Caution: *This procedure results in up to $\pm 10\%$ reading error and the DLC will no longer be within factory specifications.*

1. To open calibration mode, enter 48 into register 40501.
2. To enter Nominal Calibration Settings, enter 77 (Input Ch A and Analog Out 1) or 177 (Input Ch B and Analog Out 2) into register 40501.
3. To save the Nominal Calibration Settings and close calibration mode, enter 0 into register 40501.

* - Dependent on successful mV calibration.

DLC REGISTER TABLE

The below limits are shown as Integers or HEX <> values. Read and write functions can be performed in either Integers or Hex as long as the conversion was done correctly. Negative numbers are represented by two's complement.

Note 1: The DLC should not be powered down while parameters are being changed. Doing so may corrupt the non-volatile memory resulting in checksum errors.

REGISTER ADDRESS ¹		REGISTER NAME	LOW LIMIT ²	HIGH LIMIT ²	FACTORY SETTING ³	ACCESS	COMMENTS
CH A	CH B	CONTROLLING VALUES					
40001	40017	Process Value	N/A	N/A	N/A	Read Only	Process value of present input level. This value is affected by Input Type, Resolution, & Scaling. In Square Root Extraction Modes, the Process Value will read zero for inputs below 0.1% of full scale.
40002	40018	Setpoint Value	-32000	32000	0	Read/Write	Limited by Setpoint Limit Low and Setpoint Limit High.
40003	40019	Alarm 1 Value	-32000	32000	0	Read/Write	
40004	40020	Alarm 2 Value	-32000	32000	0	Read/Write	
PID PARAMETERS							
40005	40021	Output Power	0 or -1000	1000	0	Read/Write	1 = 0.1%, 0.0 = Off; Limited by Power Low Limit and Power High Limit in Automatic Control Mode. Negative percent is cooling (direct) available when AL2 is Cooling. Write only possible during Manual mode.
40006	40022	Setpoint Deviation	N/A	N/A	N/A	Read Only	Deviation = Process Value - Setpoint Value; During Auto-Tune: Process Value - Auto-Tune Setpoint Value
40007	40023	Proportional Band	0	9999	40	Read/Write	0 = On/Off Control, 1 = 0.1%
40008	40024	Integral Time	0	9999	120	Read/Write	0 = Off, 1 = 1 second
40009	40025	Derivative Time	0	9999	30	Read/Write	0 = Off, 1 = 1 second
40010	40026	Offset Power	-1000	1000	0	Read/Write	1 = 0.1%; Applied when Integral Time is 0.
40011	40027	Auto-Tune Start	0	1	0	Read/Write	0 = Stop, 1 = Start; Mirror of Coil 16/28.
40012	40028	Auto-Tune Phase	N/A	N/A	N/A	Read Only	0 = Off, 4 = Last phase during Auto-Tune
40013	40029	Auto-Tune Code	0	2	0	Read/Write	0 = Fastest response, 2 = Slowest response
OUTPUT STATUS							
40014	40030	Control Output OP1	N/A	N/A	N/A	Read Only	0 = Off, 1 = On; Mirror of Coil 9/21.
40015	40031	Alarm Output AL1	0	1	0	Read/Write	0 = Off, 1 = On; A write of 1 is only possible when alarm is set for Manual. Mirror of Coil 10/22.
40016	40032	Alarm Output AL2 / OP2	0	1	0	Read/Write	0 = Off, 1 = On; A write of 1 is only possible when alarm is set for Manual. Mirror of Coil 11/23.
CONTROL STATUS							
40041	40049	Control Mode	0	1	0	Read/Write	0 = Automatic, 1 = Manual; Mirror of Coil 12/24.
40042	40050	Disable Setpoint Ramping	0	1	0	Read/Write	0 = Enabled, 1 = Disabled; Mirror of Coil 13/25.
40043	40051	Setpoint Ramping In Process	N/A	N/A	N/A	Read Only	0 = No, 1 = Yes; Mirror of Coil 14/26.
40044	40052	Disable Integral Action	0	1	0	Read/Write	0 = Enabled, 1 = Disabled; Mirror of Coil 15/27
40045	40053	Ramping Setpoint Value	N/A	N/A	N/A	Read/Write	Actual Setpoint Value used for control (ramps when ramping enabled.) Limited by Setpoint Limit Low and Setpoint Limit High.
40046		Remote / Local Setpoint Select	0	1	0	Read/Write	0 = Local Setpoint, 1 = Remote Setpoint
PROFILE OPERATION						SETPOINT CONTROLLER MODEL ONLY	
40065	40073	Profile Operating Status	0	3	0	Read/Write (0-3 only)	0 = Off; 1 = Abort; 2 = Run/Start, 3 = Pause, 4 = Error Delay (status only - writing a "4" will revert unit to mode "3" Pause)
40066	40074	Profile Phase	N/A	N/A	N/A	Read Only	0 = Ramp; 1 = Hold
40067	40075	Profile Segment	N/A	N/A	N/A	Read Only	(0 = Stop, 1-20 = Current Segment)
40068	40076	Profile Phase Time Remaining	1	9999	N/A	Read/Write	1 = 0.1 Minute; Can make temporary change on the fly Value Over-range = 32003 (may occur on extremely slow ramp; Ramp will function properly)
40069	40077	Profile Cycle Count Remaining	1	250	0	Read/Write	0-250; If Cycle Count (40326/40426) is 250 (Continuous operation), value will reset to 250 at 0.
40070	40078	Advance Profile Phase	0	1	0	Read/Write	1 = Advances "running" Profile to next ramp or hold phase
INPUT PARAMETERS							
	40198	Ch B Assignment	0	1	0	Read/Write	0 = PID, 1 = Remote Setpoint
	40199	Local / Remote Setpoint Transfer Mode	0	2	0	Read/Write	0 = Normal (Output may bump) 1 = Auto (Output may bump) 2 = Track (Local Setpoint assumes value of Remote SP for Remote to Local Transfer)
40101	40201	Input Type	0	17	2	Read/Write	See Input Listing
40102	40202	Temperature Scale	0	1	0	Read/Write	0 = °F, 1 = °C, For Input Types 0-11.
40103	40203	Resolution	0	1	0	Read/Write	Input Types 0-12 0=Low (x1) whole input units, 1 = High (x10) tenth of input units, Input Type 13 0 = 0.1 mV, 1 = 0.01 mV, Input Types 14-15, N/A

¹ For Input Registers, replace the 4xxxx with a 3xxxx in the above register address. The 3xxxx are a mirror of the 4xxxx Holding Registers.

² An attempt to exceed a limit will set the register to its high or low limit value.

³ See MODBUS Calibration for procedure on restoring Factory Settings.

DLC REGISTER TABLE Continued

REGISTER ADDRESS ¹		REGISTER NAME	LOW LIMIT ²	HIGH LIMIT ²	FACTORY SETTING ³	ACCESS	COMMENTS
CH A	CH B	INPUT PARAMETERS					
40104	40204	Rounding	1	100	1	Read/Write	Greater than 1 causes rounding starting at least significant digit.
40105	40205	Digital Input Filter	0	4	1	Read/Write	0 = Least, 4 = Highest
40106	40206	Span Correction / Remote Setpoint Ratio Multiplier	1	32000	10000	Read/Write	10000 = 1.0000 (applies no correction), 1 = 0.0001, For Input Types 0-11. Applies to all inputs (0-15) for ChB when ChB is configured for Remote Setpoint (40198).
40107	40207	Offset Correction / Remote Setpoint Bias Offset	-32000	32000	0	Read/Write	For Input Types 0-13/ Applies to all inputs (0-15) for ChB when ChB is configured for Remote Setpoint (40198).
		SETPOINT PARAMETERS					
40108	40208	Low Limit	-32000	32000	0	Read/Write	ChB value also applies to Remote Setpoint
40109	40209	High Limit	-32000	32000	32000	Read/Write	ChB value also applies to Remote Setpoint
40110	40210	Ramp Rate	0	32000	0	Read/Write	1 = 0.1° per minute for input types 0-11, 0.1 ohms for input type 12, 0.01 mV for input type 13, 0.1 process units for input types 14-15, 0 = off (ChB Ramp Rate is Non-functional in remote setpoint mode)
		SCALING POINTS PARAMETERS					
40111	40211	Process Low	-32000	32000	0	Read/Write	For Input Types 14-15
40112	40212	Process High	-32000	32000	1000	Read/Write	For Input Types 14-15
40113	40213	Input Low	-32000	32000	4000	Read/Write	1 = 0.001 V or 0.001 mA, For Input Types 14-15.
40114	40214	Input High	-32000	32000	20000	Read/Write	1 = 0.001 V or 0.001 mA For Input Types 14-15.
40115	40215	Process Decimal Point	0	5	3	Read/Write	Can be used by host to determine resolution of input. For Input Types 14-15.
CH A	CH B	CONTROL (OP1) PARAMETERS					
		NON-FUNCTIONAL IN REMOTE SETPOINT MODE (SEE 40198)					
40116	40216	Cycle Time	0	2500	20	Read/Write	1 = 0.1 second
40117	40217	Control Action	0	1	0	Read/Write	0 = Reverse Acting, 1 = Direct Acting
40118	40218	Power Low Limit	0 or -100	100	0	Read/Write	1 = 1%; Negative percent is only available to OP2 when AL2 is set for Cooling.
40119	40219	Power High Limit	0 or -100	100	100	Read/Write	1 = 1%; Negative percent is only available to OP2 when AL2 is set for Cooling.
40120	40220	Sensor Failure Power Preset	0 or -100	100	0	Read/Write	1 = 1%; Negative percent is only available to OP2 when AL2 is set for Cooling.
40121	40221	Dampening Time	0	250	3	Read/Write	1 = 1 second
40122	40222	On/Off Control Hysteresis	1	250	2	Read/Write	
		ALARM 1 (AL1) OUTPUT PARAMETERS					
40131	40231	Action	0	8	3	Read/Write	See Alarm Action Register Table.
40132	40232	Reset	0	1	0	Read/Write	0 = Automatic, 1 = Latched
40133	40233	Enable Standby Delay	0	1	0	Read/Write	0 = Disable, 1 = Enable
40134	40234	Hysteresis	1	250	1	Read/Write	
40135	40235	On Delay	0	32000	0	Read/Write	1 = 1 second
		ALARM 2 (AL2) OUTPUT PARAMETERS					
40136	40236	Action	0	9	3	Read/Write	See Alarm Action Register Table.
40137	40237	Reset	0	1	0	Read/Write	0 = Automatic, 1 = Latched; Not for Cooling Action.
40138	40238	Enable Standby	0	1	0	Read/Write	0 = Disable, 1 = Enable; Not for Cooling Action.
40139	40239	Hysteresis	1	250	1	Read/Write	Not for Cooling Action.
40140	40240	On Delay	0	32000	0	Read/Write	1 = 1 second; Not for Cooling Action.
		COOLING (OP2) PARAMETERS					
		NON-FUNCTIONAL IN REMOTE SETPOINT MODE (SEE 40198)					
40141	40241	Cycle Time	0	2500	20	Read/Write	1 = 0.1 second; 0 = OP2 Off
40142	40242	Relative Gain	0	100	10	Read/Write	1 = 0.1; 0 = On/Off Control
40143	40243	Deadband	-32000	32000	0	Read/Write	
OUT 1	OUT 2	ANALOG OUTPUT PARAMETERS					
		ANALOG MODEL ONLY					
40301	40309	Assignment	0	11	0(Out 1) 6(Out 2)	Read/Write	See Analog Output Assignment Register Table.
40302	40310	Mode	1	3	3	Read/Write	1 = 0-10 V, 2 = 0-20 mA, 3 = 4-20 mA
40303	40311	Scaling Value Low	-32000	32000	0	Read/Write	Corresponds with 0 V, 0 mA or 4 mA output.
40304	40312	Scaling Value High	-32000	32000	1000	Read/Write	Corresponds with 10 V or 20 mA output.
40305	40313	Deadband	0	250	0	Read/Write	1 = 0.1%; Applies when Assignment is Output Power.
40306	40314	Update Time	0	250	0	Read/Write	0 = scan rate (10 updates/ sec) 1 = 1 second
40307	40315	Direct Entry Value	-32000	32000	0	Read/Write	Applies when Assignment is Direct Entry Value.
40308	40316	Filter	0	1	0	Read/Write	1 = Applies averaging when Update Time is >=1

¹ For Input Registers, replace the 4xxxx with a 3xxxx in the above register address. The 3xxxx are a mirror of the 4xxxx Holding Registers.

² An attempt to exceed a limit will set the register to its high or low limit value.

³ See MODBUS Calibration for procedure on restoring Factory Settings.

DLC REGISTER TABLE Continued

REGISTER ADDRESS ¹		REGISTER NAME	LOW LIMIT ²	HIGH LIMIT ²	FACTORY SETTING ³	ACCESS	COMMENTS	
CH A	CH B	SETPOINT CONTROLLER PROFILE PARAMETERS				SETPOINT CONTROLLER MODEL ONLY		
40321	40421	Profile Power Cycle Mode	0	4	1	Read/Write	0 = Stop (control at current active SP); 1 = Abort (manual control, 0% power); 2 = Start; 3 = Resume; 4 = Pause	
40322	40422	Profile Error Band Mode	0	3	0	Read/Write	0 = Disable Error Band, 1 = Error Band applies to Ramp Phase 2 = Error Band applies to Hold Phase 3 = Error Band applies to Both Ramp and Hold Phase	
40323	40423	Profile Error Band	1	32000	10	Read/Write	1 = 1 process unit; During Hold phase, profile is paused when process error >= error band until process error (deviation) is within the Error band (Error Band - Error Band Hysteresis)	
40324	40424	Profile Error Band Hysteresis	0	250	2	Read/Write	1 = 1 Process Unit	
40325	40425	Profile End Segment	1	20	1	Read/Write	Segment that ends the profile	
40326	40426	Profile Cycle Count	1	250	1	Read/Write	1 - 249 = Number of times to run profile 250 = Run Profile continuously	
40327	40427	Profile End Control Mode	0	1	0	Read/Write	0 = Manual Mode, 0% power; 1 = Automatic Control at last Setpoint	
SERIAL COMMUNICATION SETTINGS								
40401		Unit (Node) Address	1	247	247	Read/Write	Node serial DLC address.	
40402		Baud Rate	0	7	5	Read/Write	See Serial Baud Rate Register Table.	
40403		Parity	1	3	1	Read/Write	1 = None, 2 = Even, 3 = Odd	
40404		Data Bits	0	1	1	Read/Write	0 = 7 bits, 1 = 8 bits	
40405		MODBUS Protocol	0	1	1	Read/Write	0 = ASCII Mode, 1 = RTU Mode	
40406		Transmit Delay	2	250	2	Read/Write	2 = 2 msec; See Transmit Delay explanation.	
40407		Load Serial Settings	0	1	0	Read/Write	Changing 40401-40406 will not update the DLC until 40407 is 1. After a write, the communicating device must be changed to the new DLC settings and 40407 returns to 0.	
CALIBRATION								
40501		Unit Calibration	N/A	N/A	N/A	Read/Write	See MODBUS Calibration explanation.	
40502		Calibration Data Register	N/A	N/A	N/A	Read/Write	See MODBUS Calibration explanation.	
40503		Non-Volatile Memory Write Disable	0	1	0	Read/Write	0 = Enable writes, 1 = Disable writes; Returns to 0 at power cycle. Mirror of Coil 4.	
40504		Input Error Status Register	N/A	N/A	N/A	Read Only	Bits 0-7 are mirror of Coils 5-8/17-20, See Coils Table.	
40505		Checksum Error Status Register	0	N/A	0	Read/Write	Bits 0-3 are mirror of Coils 1-3, See Coils Table.	
CHA	CHB	SETPOINT CONTROLLER PROFILE SEGMENTS				SETPOINT CONTROLLER MODEL ONLY		
40601 to 40620	40701 to 40720	Setpoint Value Segment 1 - 20	-32000	32000		Read/Write	Limited by Setpoint Limit Low and Setpoint Limit High.	
40621 to 40640	40721 to 40740	Ramp Rate Segment 1 - 20	0	32000		Read/Write	1 = 0.1° per minute for input types 0-11, 0.1 ohms for input type 12, 0.01 mV for input type 13, 0.1 process units for input types 14-15, 0 = Off	
40641 to 40660	40741 to 40760	Hold Time Segment 1 - 20	0	9999		Read/Write	1 = 0.1 minute	
41001-41010		Slave ID	N/A	N/A	N/A	Read Only	RLC-DLC1xx00 (model) 2.00 version (maybe higher) 32 reads, 32 writes 16 scratch. See FC17 explanation.	
41101-41116		GUID/Scratch Pad	N/A	N/A	N/A	Read/Write	This area is for the user to store any related information. This register area does not affect DLC operations.	

¹ For Input Registers, replace the 4xxxx with a 3xxxx in the above register address. The 3xxxx are a mirror of the 4xxxx Holding Registers.

² An attempt to exceed a limit will set the register to its high or low limit value.

³ See MODBUS Calibration for procedure on restoring Factory Settings.