



Chipsmall Limited consists of a professional team with an average of over 10 year of expertise in the distribution of electronic components. Based in Hongkong, we have already established firm and mutual-benefit business relationships with customers from,Europe,America and south Asia,supplying obsolete and hard-to-find components to meet their specific needs.

With the principle of “Quality Parts,Customers Priority,Honest Operation,and Considerate Service”,our business mainly focus on the distribution of electronic components. Line cards we deal with include Microchip,ALPS,ROHM,Xilinx,Pulse,ON,Everlight and Freescale. Main products comprise IC,Modules,Potentiometer,IC Socket,Relay,Connector.Our parts cover such applications as commercial,industrial, and automotives areas.

We are looking forward to setting up business relationship with you and hope to provide you with the best service and solution. Let us make a better world for our industry!



Contact us

Tel: +86-755-8981 8866 Fax: +86-755-8427 6832

Email & Skype: info@chipsmall.com Web: www.chipsmall.com

Address: A1208, Overseas Decoration Building, #122 Zhenhua RD., Futian, Shenzhen, China



DLVR SERIES LOW VOLTAGE DIGITAL PRESSURE SENSORS

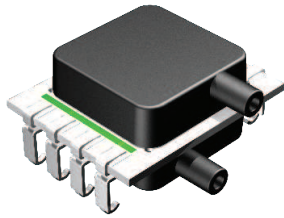

Features

- 0.5 to 60 inH₂O Pressure Ranges
- 3.3V Supply Voltage Standard / 5V Option
- I²C Standard Interface / SPI Interface Option
- Better than 1.0% Accuracy Over Temperature Typical

Applications

- Medical Breathing
- Environmental Controls
- HVAC
- Industrial Controls
- Portable/Hand-Held Equipment

General Description

The DLVR Series Mini Digital Output Sensor is based on All Sensors' CoBeam²™ Technology. This reduces package stress susceptibility, resulting in improved overall long term stability. The technology also vastly improves position sensitivity compared to single die devices.

The supply voltage options ease integration of the sensors into a wide range of process control and measurement systems, allowing direct connection to serial communications channels. For battery-powered systems, the sensors can enter very low-power modes between readings to minimize load on the power supply.

These calibrated and compensated sensors provide accurate, stable output over a wide temperature range. This series is intended for use with non-corrosive, non-ionic working fluids such as air, dry gases and the like. A protective parylene coating is optionally available for moisture/harsh media protection.

Standard Pressure Ranges					Equivalent Circuit
Device	Operating Range	Proof Pressure	Burst Pressure	Nominal Span	
DLVR-F50D	±0.5 inH ₂ O	100 inH ₂ O	300 inH ₂ O	±6,553 counts	
DLVR-L01D	±1 inH ₂ O	100 inH ₂ O	300 inH ₂ O	±6,553 counts	
DLVR-L02D	±2 inH ₂ O	100 inH ₂ O	300 inH ₂ O	±6,553 counts	
DLVR-L05D	±5 inH ₂ O	200 inH ₂ O	300 inH ₂ O	±6,553 counts	
DLVR-L10D	±10 inH ₂ O	200 inH ₂ O	300 inH ₂ O	±6,553 counts	
DLVR-L20D	±20 inH ₂ O	200 inH ₂ O	500 inH ₂ O	±6,553 counts	
DLVR-L30D	±30 inH ₂ O	200 inH ₂ O	500 inH ₂ O	±6,553 counts	
DLVR-L60D	±60 inH ₂ O	200 inH ₂ O	800 inH ₂ O	±6,553 counts	
DLVR-L01G	0 to 1 inH ₂ O	100 inH ₂ O	300 inH ₂ O	13,107 counts	
DLVR-L02G	0 to 2 inH ₂ O	100 inH ₂ O	300 inH ₂ O	13,107 counts	
DLVR-L05G	0 to 5 inH ₂ O	200 inH ₂ O	300 inH ₂ O	13,107 counts	
DLVR-L10G	0 to 10 inH ₂ O	200 inH ₂ O	300 inH ₂ O	13,107 counts	
DLVR-L20G	0 to 20 inH ₂ O	200 inH ₂ O	500 inH ₂ O	13,107 counts	
DLVR-L30G	0 to 30 inH ₂ O	200 inH ₂ O	500 inH ₂ O	13,107 counts	
DLVR-L60G	0 to 60 inH ₂ O	200 inH ₂ O	800 inH ₂ O	13,107 counts	

Pressure Sensor Maximum Ratings		Environmental Specifications	
Supply Voltage (Vs)	6 Vdc	Temperature Ranges	
Common Mode Pressure	10 psig	Compensated:	Commercial Industrial
Lead Temperature (soldering 2-4 sec.)	270 °C	Operating Storage	0°C to 70°C -20°C to 85°C -25°C to 85 °C -40°C to 125 °C
		Humidity Limits (non condensing)	0 to 95% RH

Performance Characteristics for DLVR Series - Commercial and Industrial Temperature Range

ALL PARAMETERS ARE MEASURED AT 3.3V \pm 5% OR 5.0V \pm 5% (DEPENDING ON SELECTED VOLTAGE OPTION) EXCITATION AND 25°C UNLESS OTHERWISE SPECIFIED. PRESSURE MEASUREMENTS ARE WITH POSITIVE PRESSURE APPLIED TO PORT B.

Parameter	Min	Typ	Max	Units	Notes
Output Span					1
LxxD, FxxD	-	\pm 6,553	-	Dec count	
LxxG	-	13,107	-	Dec count	
Offset Output @ Zero Diff. Pressure					-
LxxD, FxxD	-	8,192	-	Dec count	
LxxG	-	1,638	-	Dec count	
Total Error Band					2
F50D	-	\pm 0.60	\pm 1.5	%Span	
L01x, L02x	-	\pm 0.50	\pm 1.0	%Span	
L05x, L10x, L20x, L30x, L60x	-	\pm 0.30	\pm 0.75	%Span	
Span Temperature Shift					3
F50D, L01x, L02x	-	\pm 0.5	-	%FSS	
L05x, L10x, L20x, L30x, L60x	-	\pm 0.2	-	%FSS	
Offset Temperature Shift					3
F50D, L01x, L02x	-	\pm 0.5	-	%FSS	
L05x, L10x, L20x, L30x, L60x	-	\pm 0.2	-	%FSS	
Offset Warm-up Shift					4
F50D, L01x, L02x	-	\pm 0.25	-	%FSS	
L05x, L10x, L20x, L30x, L60x	-	\pm 0.15	-	%FSS	
Offset Position Sensitivity (\pm1g)					-
F50D, L01x, L02x	-	\pm 0.10	-	%FSS	
L05x, L10x, L20x, L30x, L60x	-	\pm 0.05	-	%FSS	
Offset Long Term Drift (One Year)					-
F50D, L01x, L02x	-	\pm 0.25	-	%FSS	
L05x, L10x, L20x, L30x, L60x	-	\pm 0.15	-	%FSS	
Linearity, Hysteresis Error					6
F50D	-	\pm 0.30	-	%FSS	
LxxD	-	\pm 0.25	-	%FSS	
LxxG	-	\pm 0.10	-	%FSS	
Response Delay					5, 9
Sleep - Wake Pressure	-	0.40	0.50	ms	
Sleep - Wake All	-	1.10	1.40	ms	
Power-On to First Reading Attempt	6.0 + 1 update period	-	-	ms	
Update Rate					5
Fast	-	0.40	1.0	ms	
Noise Reduced	-	1.30	3.1	ms	
Low Power	-	6.5	9.5	ms	
Digital Resolution					-
Output Resolution	-	14	-	bit	
No Missing Codes	12	13	-	bit	
Temperature Output					7
Resolution	-	11	-	bit	
Overall Accuracy	-	2	-	°C	
Current Requirement (3.3V Option)					5
Fast	-	3.5	4.3	mA	
Noise Reduced	-	3.6	4.5	mA	
Low Power	-	0.72	0.90	mA	
Sleep (Idle)	-	0.5	5.0	uA	
Current Requirement (5.0 Option)					5
Fast	-	5.0	6.0	mA	
Noise Reduced	-	5.2	6.2	mA	
Low Power	-	1.1	1.3	mA	
Sleep (Idle)	-	0.5	5.0	uA	

See following page for performance characteristics table notes

I2C / SPI Electrical Parameters for DLVR Series

Parameter	Symbol	Min	Typ	Max	Units	Notes
Input High Level	-	80.0	-	100	% of Vs	5
Input Low Level	-	0	-	20.0	% of Vs	5
Output Low Level	-	-	-	10.0	% of Vs	5
I2C Pull-up Resistor	-	1000	-	-	Ω	5,8
I2C Load Capacitance on SDA, @ 400 kHz	C _{SDA}	-	-	200	pF	5
I2C Input Capacitance (each pin)	C _{I2C_IN}	-	-	10.0	pF	5

Specification Notes

NOTE 1: THE SPAN IS THE ALGEBRAIC DIFFERENCE BETWEEN FULL SCALE DECIMAL COUNTS AND THE OFFSET DECIMAL COUNTS.

NOTE 1: Pressure Output Transfer Function:

$$Pressure(inH2O) = 1.25 \times \left(\frac{Pout_{dig} - OS_{dig}}{2^{14}} \right) \times FSS(inH2O)$$

Where,

$Pout_{dig}$ Is the sensor 14 bit digital output.

OS_{dig} Is the specified digital offset (gage = 1,638 and differential = 8,192)

$FSS(inH2O)$ Is the sensor Full Scale Span in inH2O (gage = Full Scale Pressure, differential = 2 x Full Scale Pressure)

NOTE 2: TOTAL ERROR BAND CONSISTS OF OFFSET AND SPAN TEMPERATURE AND CALIBRATION ERRORS, LINEARITY AND PRESSURE HYSTERESIS ERRORS, OFFSET WARM-UP SHIFT, OFFSET POSITION SENSITIVITY AND LONG TERM OFFSET DRIFT ERRORS.

NOTE 3: SHIFT IS RELATIVE TO 25C.

NOTE 4: SHIFT IS WITHIN THE FIRST HOUR OF EXCITATION APPLIED TO THE DEVICE.

NOTE 5: PARAMETER IS CHARACTERIZED AND NOT 100% TESTED.

NOTE 6: MEASURED AT ONE-HALF FULL SCALE RATED PRESSURE USING BEST STRAIGHT LINE CURVE FIT.

NOTE 7: TEMPERATURE OUTPUT CONVERSION FUNCTION:

$$Temperature (^{\circ}C) = Tout_{dig} \times \left(\frac{200}{2^{11} - 1} \right) - 50$$

NOTE 8: A PULL-UP RESISTOR IS REQUIRED FOR CORRECT I2C USAGE. THE MINIMUM VALUE INDICATED IS FOR 5.0V OR 3.3V OPERATION.

NOTE 9: FOLLOWING SENSOR POWER-UP, THE APPLICATION MUST WAIT AT LEAST THE INDICATED TIME BEFORE ATTEMPTING TO COMMUNICATE WITH THE SENSOR.

Device Options

The following is a list of factory programmable options. Consult the factory to learn more about the options.

Interface

I2C and SPI interfaces are available. NOTE: SPI interface is only available with eight (8) lead packages.

Supply Voltage

Devices are characterized at either 3.3V or 5.0V depending on the options selected. It is suggested to select the option that most closely matches the application supply voltage for best possible performance.

Speed/Power

There are four options of Speed/Power. These are Fast(F), Noise Reduced(N), Low Power(L) and Sleep mode(S).

Fast Mode(F) Is the fastest operating mode where the device operates with continuous sampling at the fastest internal speed.

Noise Reduced(N): Also operates with continuous samples however the ADC is set for over sampling for noise reduction. The conversion times are resultantly longer than the Fast(F) mode however, there is approximately 1/2 bit reduction in noise.

Low Power(L): Is similar to the Fast(F) mode with exception that the device uses an internal timer to delay between pressure conversions. The internal timer time-out triggers the next conversion cycle. The update rate is commensurately lower for this mode as a result.

Sleep(S): Is similar to the Low Power(L) mode however the trigger to initiate a sample comes from the user instead of an internal timer. This is ideal for very low update rate applications that require low power usage. It is also ideal for synchronizing the data conversions with the host microprocessor.

Coating

Parylene Coating: Parylene coating provides a moisture barrier and protection from some harsh media. Consult factory for applicability of Parylene for the target application and sensor type.

Operation Overview

The DLVR is a digital sensor with a signal path that includes a sensing element, a 14 bit analog to digital converter, a DSP and an IO block that supports either an I2C or SPI interface (see Figure 1 below). The sensor also includes an internal temperature reference and associated control logic to support the configured operating mode. The sensing element is powered down while not being sampled to conserve power. Since there is a single ADC, there is also a multiplexer at the front end of the ADC that selects the signal source for the ADC.

Figure 1 - DLVR Essential Model

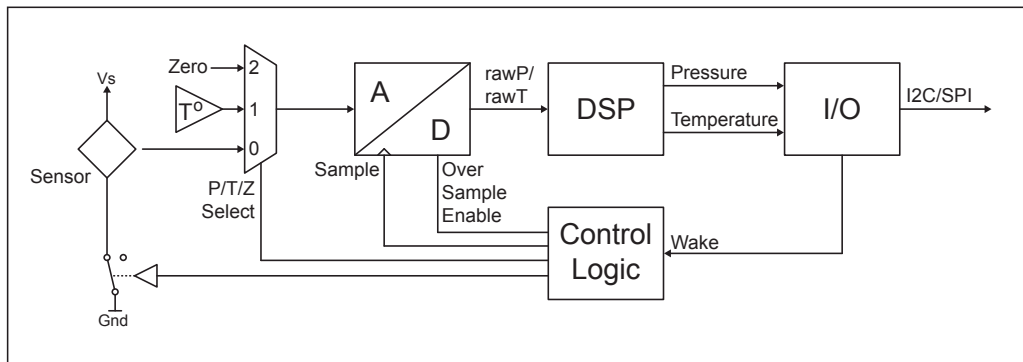

The ADC performs conversions on the raw sensor signal (P), the temperature reference (T) and a zero reference (Z) during an ADC zero cycle. It also has an oversampling mode for a noise reduced output. A conversion cycle that is measuring pressure is called a Normal cycle. A cycle where either a temperature measurement or zeroing is being performed is called a Special cycle.

The DSP receives the converted pressure and temperature information and applies a multi-order transfer function to compensate the pressure output. This transfer function includes compensation for span, offset, temperature effects on span, temperature effects on offset and second order temperature effects on both span and offset. There is also linearity compensation for gage devices and front to back linearity compensation for differential devices.

There are two effective operating modes of the sensor 1) Free Running and 2) Triggered. The control logic performs the synchronization of the internal functions according the factory programmed Power/Speed option (see Table 1). The Control Logic also determines the Delay between ADC samples, the regularity of the Special cycles and whether or not the ADC performs the Over Sampling. Refer to Figure 2 for the communication model associated with the operating modes listed below.

Free Running Mode: In the free running mode, conversion cycles are initiated internally at regular intervals. There are three options available that operate in the Free Running mode (F, N and L). Two of these (F and N) run continuously while the third option (L) has an approximate 6 ms delay between conversion cycles. All three options have Special cycles inserted at regular intervals to accomplish the ADC zeroing and temperature measurements. Two of the options utilize oversampling. Refer to Table 1 for specific option controls.

Triggered Mode: In the Triggered Mode, a conversion cycle is initiated by the user (or host uP). There are two available methods to wake the sensor from sleep mode. The first method (Wake All) is to wake the sensor and perform all three measurement cycles (Z, T and P). This provides completely fresh data from the sensor. The second method (Wake P) is to wake the sensor from sleep and only perform the pressure measurement (P). When using this second method, it is up to the user to interleave Wake All commands at regular intervals to ensure there is sufficiently up to date temperature information. Also, the Wake Pressure method is only available from the I2C interface (not available using a SPI interface).

Operation Overview (Cont'd)

Table 1 - DLVR Control Logic Detail

Control Logic							
Power/Speed Option	Power/Speed Description	Operating Mode	Over Sample	Delay Between Samples	Normal ADC Cycles	Special ADC Cycles	Special ADC Cycle Interval
F	Fast	Free Running	No	No	1 (P)	1 (Z or T)	255
N	Noise Reduced		Yes	No	1 (P)	1 (Z or T)	255
L	Low Power		Yes	Yes	1 (P)	1 (Z or T)	31
S	Sleep ⁽¹⁾ (Wake Pressure)	Triggered	No	User Defined	1 (P)	n/a	Never
	Sleep (Wake All)		No	User Defined	1 (P)	2 (Z + T)	Always

Note 1) Wake from sleep with pressure only reading is not available with SPI interface (I2C only).

Figure 2 - DLVR Communication Model

Free Running Mode [(F)ast, (N)oise Reduced and (L)ow Power Option]

Cycle Type	Normal Cycle			Normal Cycle			Special Cycle ⁽¹⁾						
Internal Operation	DSP	Delay	ADC (P)	DSP	Delay	ADC (P)	DSP	Delay	ADC (P)	ADC (T or Z)	DSP	Delay	ADC (P)
New Data Available													

Note 1: See Table 1 for frequency of Special Cycles

Triggered Mode - Wake All [(S)leep Option]

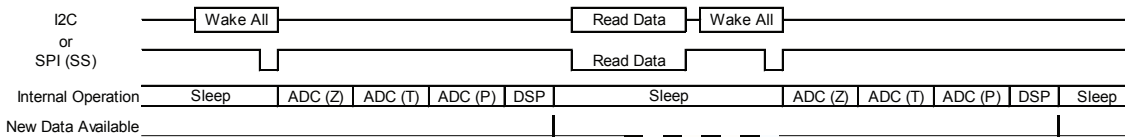

Triggered Mode - Wake Pressure [(S)leep Option]

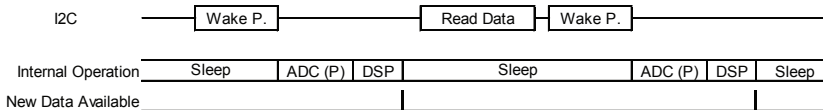

Digital Interface Data Format

For either type of digital interface, the format of data returned from the sensor is the same. The first 16 bits consist of the 2 Status bits followed by the 14-bit the pressure value. The third byte provides the 8 most significant bits of the measured temperature; the fourth byte provides the 3 least significant bits of temperature, followed by 5 bits of undefined filler data. With either interface, the host may terminate the transfer after receiving the first two bytes of data from the sensor, or following the third byte (if just the most-significant 8 bits of temperature are needed). Refer to Table 2 for the overall data format of the sensor. Table 3 shows the Status Bit definition.

Table 2 - Output Data Format

D[31:30]	D[29:24]	D[23:16]	D[15:8]	D[7:5]	D[4:0]
S[1:0]	P[13:8]	P[7:0]	T[10:3]	T[2:0]	X[4:0]
Status	Pressure MSB	Pressure LSB	Temperature MSB	Temperature LSB	Filler bits (Undefined)

Bit Definitions:

Status (S): Normal/command / busy / diagnostic

Pressure (P): Digital pressure reading

Temperature (T): Compensated temperature reading

Table 3- Status Bit Definitions

[00]	[01]	[10]	[11]
Current Data, no errors.	(Reserved)	Stale Data: Not updated since last read.	Error Condition: electrical fault or configuration invalid.

I2C Interface

I2C Communications Overview

The I2C interface uses a set of signal sequences for communication. The following is a description of the supported sequences and their associated mnemonics. Refer to Figure 3 for the associated usage of the following signal sequences.

Bus not Busy (I): During idle periods both data line (SDA) and clock line (SCL) remain HIGH.

START condition (ST): A HIGH to LOW transition of SDA line while the clock (SCL) is HIGH is interpreted as START condition. START conditions are always set by the master. Each initial request for a pressure value has to begin with a START condition.

Slave address (An): The I²C-bus requires a unique address for each device. The DLVR sensor has a preconfigured slave address (0x28). After setting a START condition the master sends the address byte containing the 7 bit sensor address followed by a data direction bit (R/W). A "0" indicates a transmission from master to slave (WRITE), a "1" indicates a data request (READ).

Acknowledge (A or N): Data is transferred in units of 8 bits (1 byte) at a time, MSB first. Each data-receiving device, whether master or slave, is required to pull the data line LOW to acknowledge receipt of the data. The Master must generate an extra clock pulse for this purpose. If the receiver does not pull the data line down, a NACK condition exists, and the slave transmitter becomes inactive. The master determines whether to send the last command again or to set the STOP condition, ending the transfer.

DATA valid (Dn): State of data line represents valid data when, after a START condition, data line is stable for duration of HIGH period of clock signal. Data on line must be changed during LOW period of clock signal. There is one clock pulse per data bit.

DATA operation: The sensor starts to send 4 data bytes containing the current pressure and temperature values. The transmission may be halted by the host after any of the bytes by responding with a NACK.

STOP condition (P): LOW to HIGH transition of the SDA line while clock (SCL) is HIGH indicates a STOP condition. STOP conditions are always generated by the master.

I2C Communications Overview (Cont'd)

Figure 3 - I2C Communication Diagram

I2C Communications Diagram

1. Start All (to wake sensor from Sleep mode, Zero ADC, read Temperature and read Pressure)

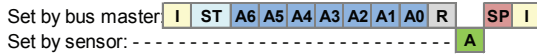

2. Start Pressure (to wake sensor from Sleep mode and read Pressure only)

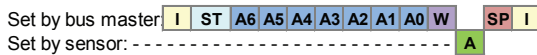

3. Read Data (with examples of reading pressure, pressure plus 8 bits of temperature and pressure plus 11 bits of temperature)

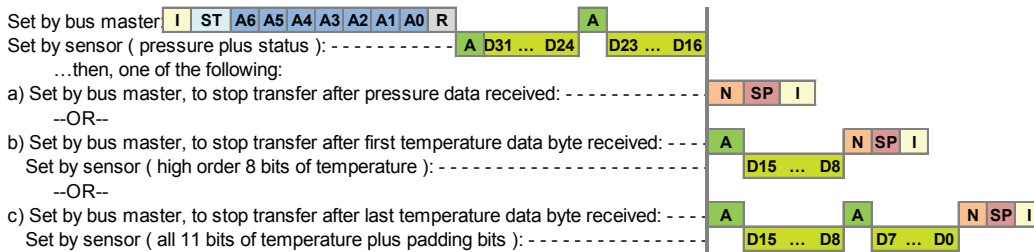

Bus states	
Idle:	I
Start:	ST
Stop:	SP
Ack:	A
Nack:	N
"Read" bit (1):	R
"Write" bit (0):	W

Sensor Address	
A6 ... A0	
Default:	0x28

Data format	
Status:	D31 D30
Pressure data:	D29 ... D16
Temperature data:	D15 ... D5
(padding bits:)	D4 ... D0

Figure 3 illustrates the sequence of signals set by both the host and the sensor for each command. Note that for the DataRead command, the host has the option of responding to the second or third bytes of data with a NACK instead of ACK. This terminates the data transmission after the pressure data, or after the pressure data and upper byte of temperature, have been transmitted. See Figure 6 for the I2C timing details.

I2C Command Sequence

Depending on whether the Fast, Noise Reduced, Low-Power, or Sleep options have been selected, the command sequence differs slightly. See Figure 3 for details of the three I2C commands.

Fast, Noise Reduced or Low-power Configuration

The part enters Free Running mode (see table 1) after power-up: it performs an initial complete measurement, writes the calculated data to the output registers, sets the INT pin high, then goes to sleep. After a delay determined by the update rate option, the part will wake up, perform measurements, update the output registers, then go back to sleep. DataRead is the only command recognized; as with the Sleep configuration, if the INT pin is ignored, the host processor can repeat this command until the Status bits indicate an updated reading.

Sleep Configuration

The part enters Triggered mode (see table 1) after power-up, and waits for a command from the bus master. If the StartAll command is received, the temperature, ADC zero, and pressure readings are all measured, and correction calculations are performed. When valid data is written to the output registers, the INT pin is set high, and the processing core goes back to sleep. The host processor then sends the DataRead command to shift out the updated values. If the INT pin is not monitored, the host can poll the output registers by repeating the DataRead command until the Status bits indicate that the values have been updated (see Tables 2 and 3). The response time depends on configuration options (refer to Table 1 and Performance Characteristics).

Depending on the application, pressure measurements may be performed by sending the StartPressure command, which only measures the pressure value and uses previously measured temperature data in calculating the compensated output value. This presents the result faster (in about 1/3 the delay time) than the StartAll command. This can be a useful method to synchronize the sensor with the host controller as well as attaining the fastest overall response time without Special cycles occurring at unwanted times. The system designer should determine the interval required for sending StartAll commands, necessary to refresh the internal temperature value and zero point data, in order to maintain accurate output values.

I2C Exceptions

1. Sending a Start condition, then a Stop condition, without any transitions on the CLK line, creates a communication error for the next communication, even if the next start condition is correct and the clock pulse is applied. A second Start condition must be set, which clears the error and allows communication to proceed.
2. The Restart condition—a falling SDA edge during data transmission when the CLK clock line is still high—creates the same stall/deadlock. In the following data request, an additional Start condition must be sent for correct communication.
3. A falling SDA edge is not allowed between the start condition and the first rising SCL edge. If using an I2C address with the first bit 0, SDA must be held low from the start condition through the first bit.

SPI Interface

SPI Command Sequence

DLVR sensors using the SPI interface option provide 3 signals for communication: SCLK, SS (Slave Select), and MISO. This read-only signaling uses a hardware protocol to control the sensor, differing slightly with the speed/power option selected as described below:

Fast(F), Noise Reduced(N) and Low-Power(L) Configurations: After power-up, the part enters Free Running mode and begins its periodic conversion cycle, at the interval determined by the programmed Power/Speed option. This is the simplest configuration. The only bus interaction with the host is the SPI DataRead operations. Polling the sensor at a rate slower than the internal update rate will minimize bus activity and ensure that new values are presented with each transfer. Note that the Status bits should still be checked to verify updated data and the absence of error conditions.

Sleep(S) Configuration: As with the I2C option, the part enters Triggered mode after power-up, and waits for a command from the bus master. To wake the part and start a measurement cycle, the SS pin must be driven low by the host for at least 8 μ sec, then driven high. This can be done by shifting a dummy byte of 8 bits from the sensor. This bus activity can be considered the SPI StartAll command, where the rising edge of SS is the required input to start conversion. Updated conversion data is written to the output registers after a period dependent on configuration options (see Performance Characteristics). After this update of the registers, the core goes to an inactive (sleep) state. The DataRead command simply consists of shifting out 2, 3, or 4 bytes of data from the sensor. The host can check the Status bits of the output to verify that new data has been provided. The part remains inactive following this read operation, and another StartAll operation is needed to wake the part when the next conversion is to be performed.

SPI Bit Pattern

The sequence of bits and bus signals are shown in the following illustration (Figure 4). Refer to Figure 5 in the Interface Timing Diagram section for detailed timing data. As previously described, the incoming data may be terminated by raising SS after 2, 3, or 4 bytes have been received as illustrated below.

Figure 4 - SPI Bit Pattern

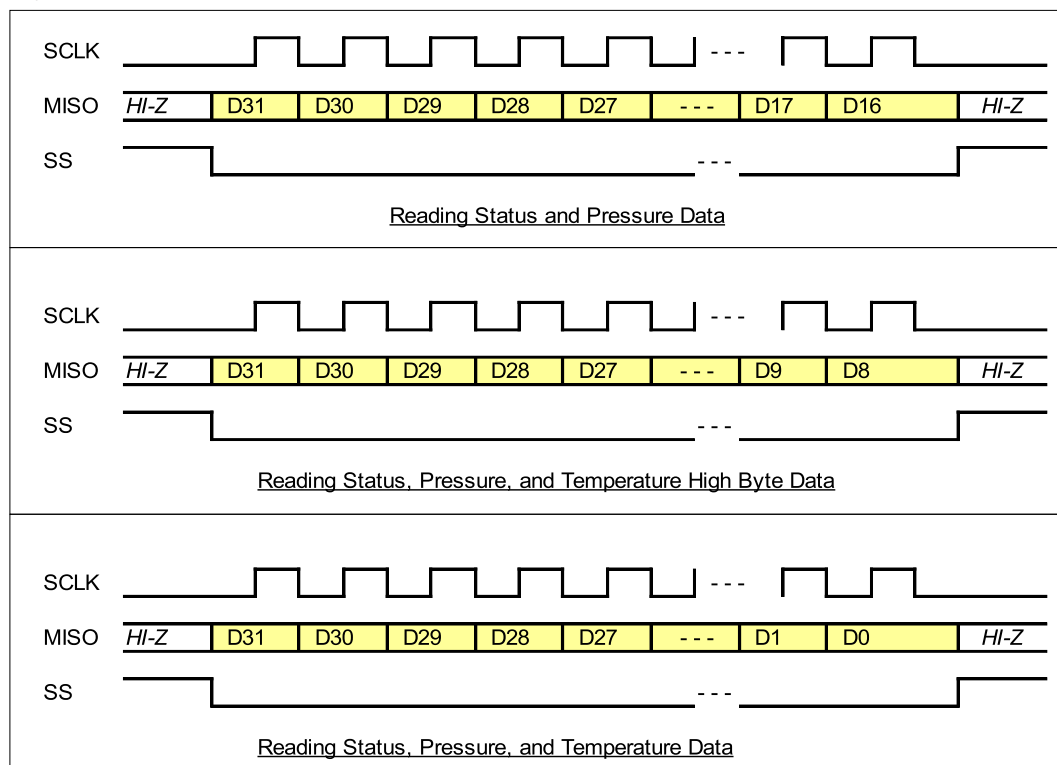

Interface Timing Diagrams

Figure 5 - SPI Timing Diagram

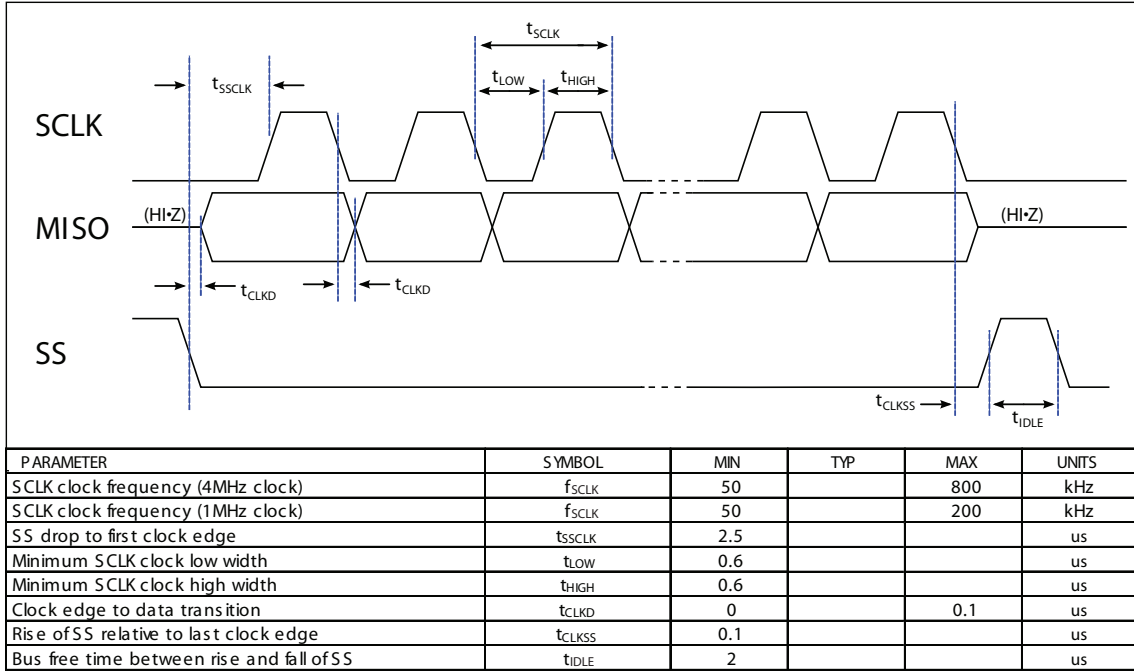
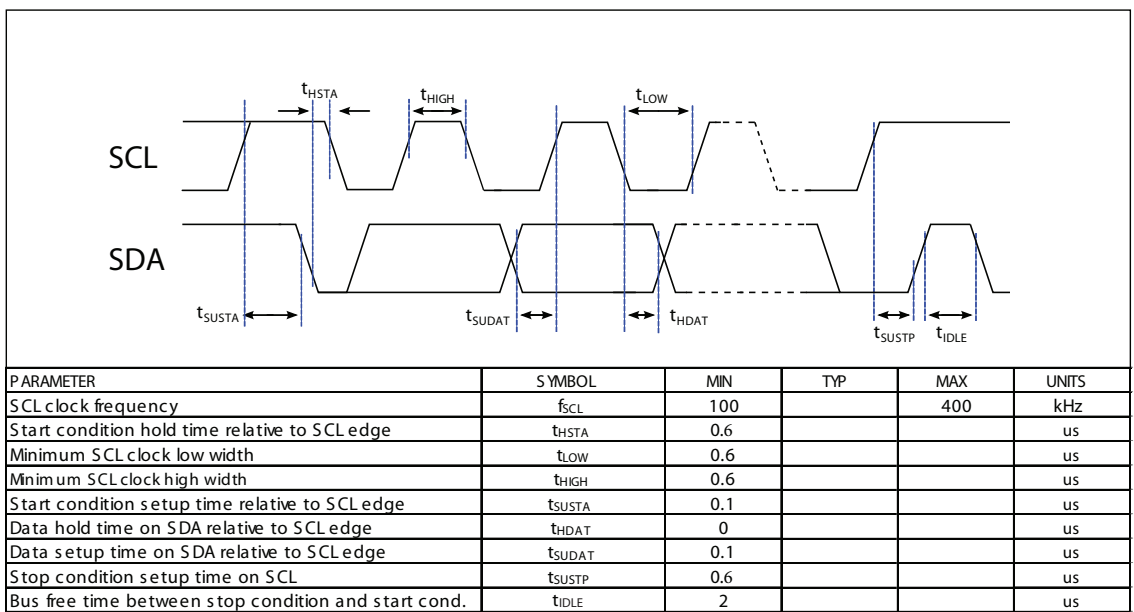

Figure 6 - I2C Timing Diagram



How to Order

Refer to Table 4 for configuring a standard base part number which includes the pressure range, package and temperature range. Table 5 shows the available configuring options. The option identifier is required to complete the device part number. Refer to Table 6 for the available device package options.

Example P/N with options: DLVR-L02D-E1NS-C-NI3F

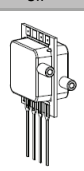

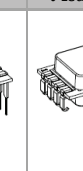
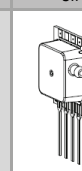
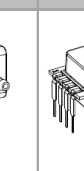
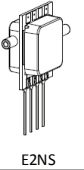

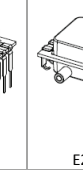
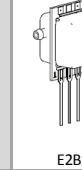

Table 4 - How to configure a base part number

ORDERING INFORMATION	SERIES		PRESSURE RANGE		PACKAGE						TEMPERATURE RANGE	
	ID	Description	ID	Description	Port Orientation		Lid Style		Lead Type		ID	Description
	DLVR	F50D ±0.5 inH2O L01D ±1 inH2O L02D ±2 inH2O L05D ±5 inH2O L10D ±10 inH2O L20D ±20 inH2O L30D ±30 inH2O L60D ±60 inH2O L01G 0 to 1 inH2O L02G 0 to 2 inH2O L05G 0 to 5 inH2O L10G 0 to 10 inH2O L20G 0 to 20 inH2O L30G 0 to 30 inH2O L60G 0 to 60 inH2O	E	1	Dual Port Same Side	Dual Port Opposite Side	N	B	S	D	J	C
Example	DLVR	L02D	-	E	1		N		S		-	C

Table 5 - How to configure an option identifier

ORDERING INFORMATION	COATING		INTERFACE		SUPPLY VOLTAGE		SPEED/POWER	
	ID	Description	ID	Description	ID	Description	ID	Description
	N	No Coating	I	I2C	3	3.3V	F	Fast
P	Parylene Coating ⁸	S	SPI	5	5.0V	N	Noise reduced	
						L	Low Power	
						S	Sleep Mode	
Example	N		I		3		F	

TABLE 6: Available E-Series Package Configurations

Port Orientation	Non-Barbed Lid Lead Style				Barbed Lid Lead Style			
	SIP	DIP	J Lead SMT	Low Profile DIP	SIP	DIP	J Lead SMT	Low Profile DIP
Dual Port Same Side	 E1NS	 E1ND	 E1NJ	N/A	 E1BS	 E1BD	N/A	N/A
Dual Port Opposite Side	 E2NS	 E2ND	 E2NJ	N/A	 E2BS	 E2BD	N/A	N/A
Single Port (Gage)	N/A	N/A	N/A	N/A	N/A	N/A	N/A	N/A

Specification Notes (Cont.)

NOTE 8: PARYLENE COATING NOT OFFERED IN J-LEAD SMT CONFIGURATION.

Package Drawings

E1NS Package

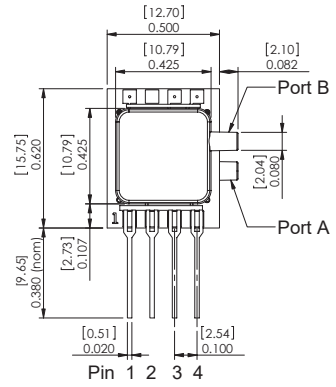
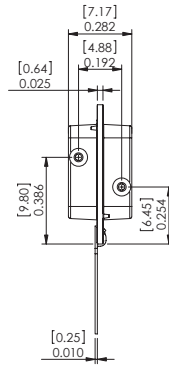
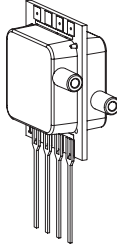

- Pinout**
- 1) Gnd
 - 2) Vs
 - 3) SDA
 - 4) SCL

NOTES
 1) Dimensions are in inches [mm]
 2) For suggested pad layout, see drawing: PAD-01

E1BS Package

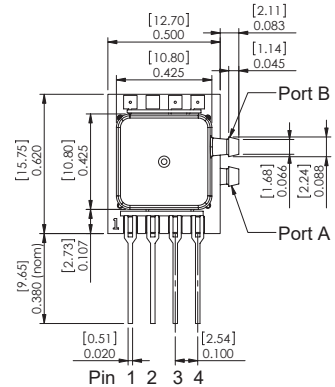
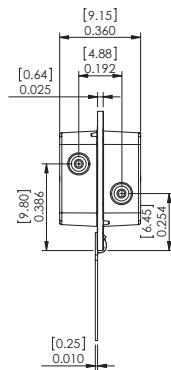
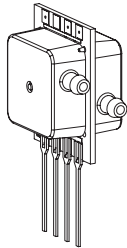

- Pinout**
- 1) Gnd
 - 2) Vs
 - 3) SDA
 - 4) SCL

NOTES
 1) Dimensions are in inches [mm]
 2) For suggested pad layout, see drawing: PAD-01

Package Drawings (Cont'd)

E2NS Package

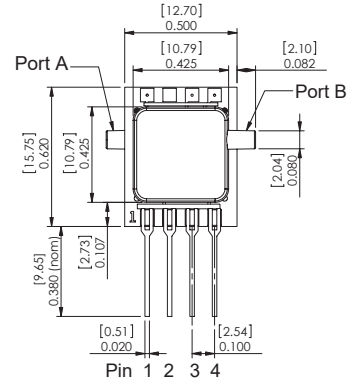
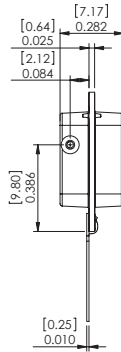
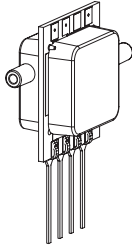

Pinout

- 1) Gnd
- 2) Vs
- 3) SDA
- 4) SCL

NOTES

- 1) Dimensions are in inches [mm]
- 2) For suggested pad layout, see drawing: PAD-01

E2BS Package

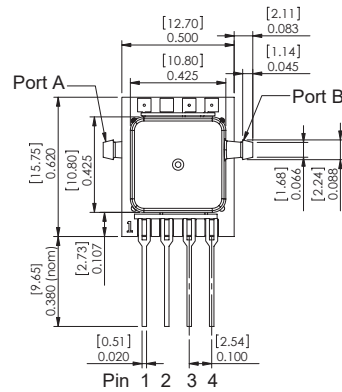
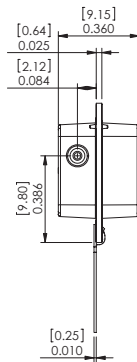
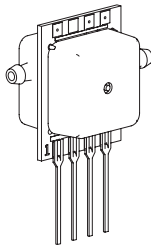

Pinout

- 1) Gnd
- 2) Vs
- 3) SDA
- 4) SCL

NOTES

- 1) Dimensions are in inches [mm]
- 2) For suggested pad layout, see drawing: PAD-01

Package Drawings (Cont'd)

E1ND Package

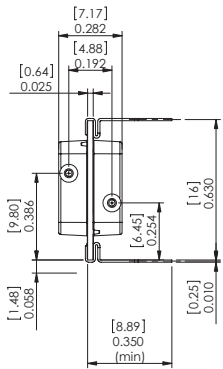
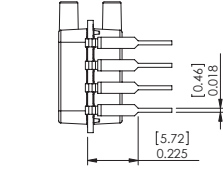
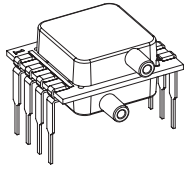

Pinout

- 1) Gnd
- 2) Vs
- 3) SDA/MISO
- 4) SCL/SCLK
- 5) INT/SS
- 6) Do Not Connect
- 7) Do Not Connect
- 8) Do Not Connect

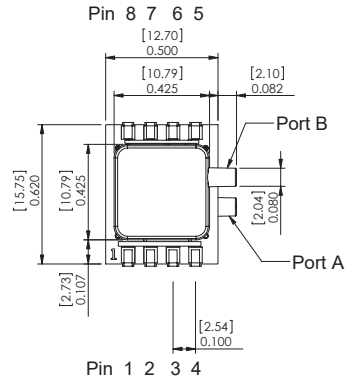

NOTES

- 1) Dimensions are in inches [mm]
- 2) For suggested pad layout, see drawing: PAD-03

E1BD Package

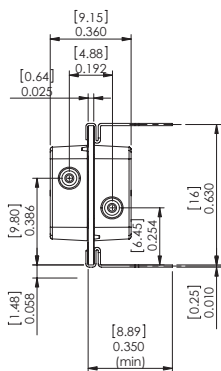
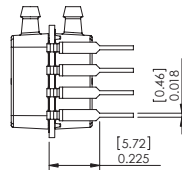
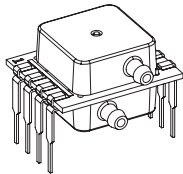

Pinout

- 1) Gnd
- 2) Vs
- 3) SDA/MISO
- 4) SCL/SCLK
- 5) INT/SS
- 6) Do Not Connect
- 7) Do Not Connect
- 8) Do Not Connect

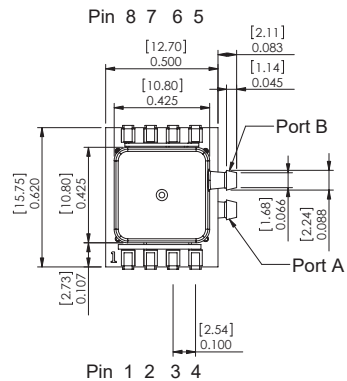

NOTES

- 1) Dimensions are in inches [mm]
- 2) For suggested pad layout, see drawing: PAD-03

Package Drawings (Cont'd)

E2ND Package

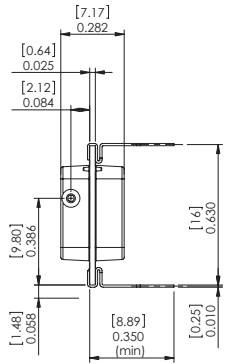
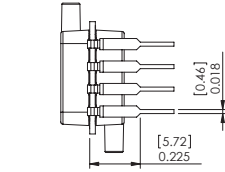
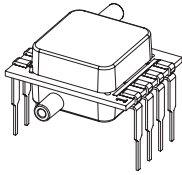

Pinout

- 1) Gnd
- 2) Vs
- 3) SDA/MISO
- 4) SCL/SCLK
- 5) INT/SS
- 6) Do Not Connect
- 7) Do Not Connect
- 8) Do Not Connect

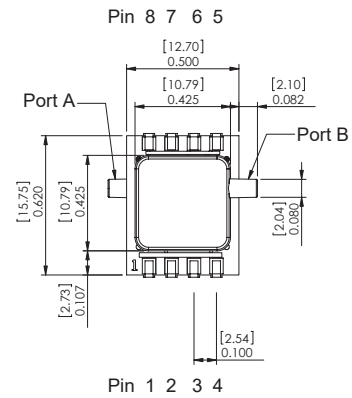

- NOTES**
- 1) Dimensions are in inches [mm]
 - 2) For suggested pad layout, see drawing: PAD-03

E2BD Package

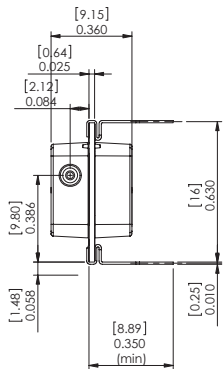
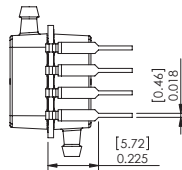
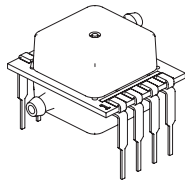

Pinout

- 1) Gnd
- 2) Vs
- 3) SDA/MISO
- 4) SCL/SCLK
- 5) INT/SS
- 6) Do Not Connect
- 7) Do Not Connect
- 8) Do Not Connect

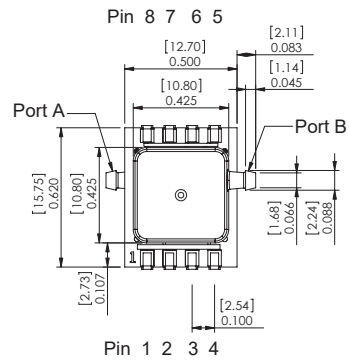

- NOTES**
- 1) Dimensions are in inches [mm]
 - 2) For suggested pad layout, see drawing: PAD-03

Package Drawings (Cont'd)

E1NJ Package

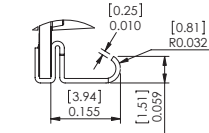
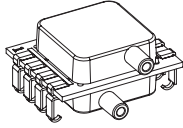

DETAIL A
SCALE 4 : 1

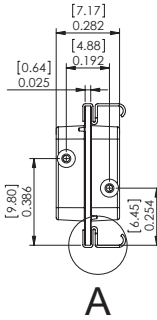

A

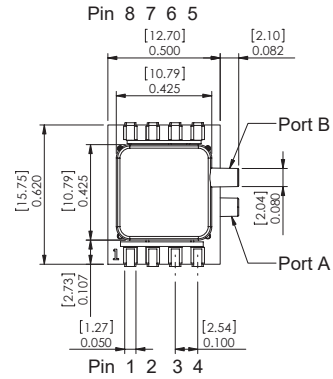

Pinout

- 1) Gnd
- 2) Vs
- 3) SDA/MISO
- 4) SCL/SCLK
- 5) INT/SS
- 6) Do Not Connect
- 7) Do Not Connect
- 8) Do Not Connect

NOTES

- 1) Dimensions are in inches [mm]
- 2) For suggested pad layout, see drawing: PAD-10

E2NJ Package

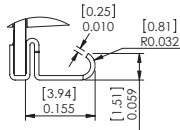
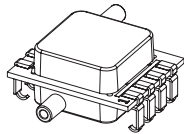

DETAIL A
SCALE 4 : 1

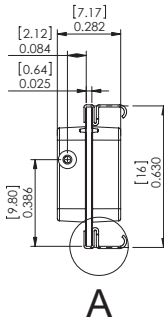

A

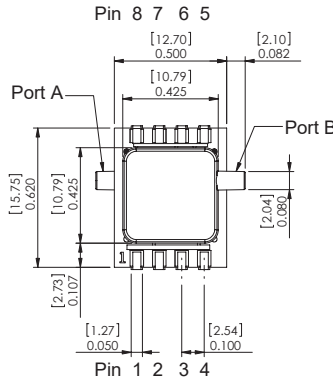

Pinout

- 1) Gnd
- 2) Vs
- 3) SDA/MISO
- 4) SCL/SCLK
- 5) INT/SS
- 6) Do Not Connect
- 7) Do Not Connect
- 8) Do Not Connect

NOTES

- 1) Dimensions are in inches [mm]
- 2) For suggested pad layout, see drawing: PAD-10

Suggested Pad Layout

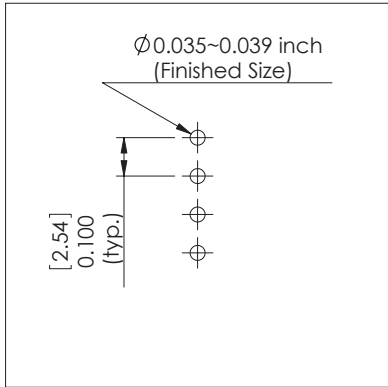

PAD-01

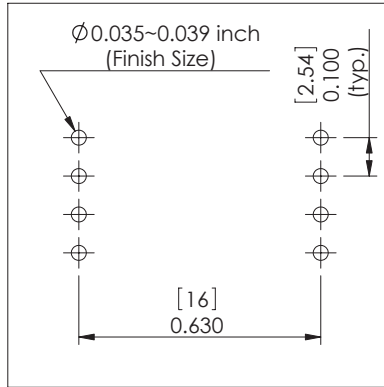

PAD-03

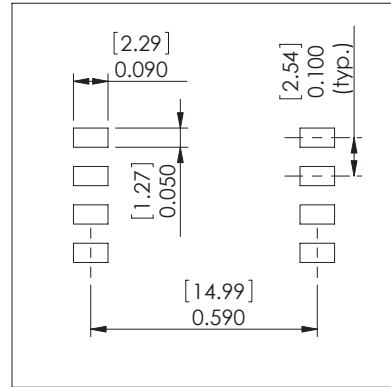

PAD-10

Product Labeling

All Sensors
DLVR-L02D-
E1NS-C-
NI3F
R13J21-12

Company

Part Number

Lot Number

Example Device Label

All Sensors reserves the right to make changes to any products herein. All Sensors does not assume any liability arising out of the application or use of any product or circuit described herein, neither does it convey any license under its patent rights nor the rights of others.