



Chipsmall Limited consists of a professional team with an average of over 10 year of expertise in the distribution of electronic components. Based in Hongkong, we have already established firm and mutual-benefit business relationships with customers from,Europe,America and south Asia,supplying obsolete and hard-to-find components to meet their specific needs.

With the principle of “Quality Parts,Customers Priority,Honest Operation,and Considerate Service”,our business mainly focus on the distribution of electronic components. Line cards we deal with include Microchip,ALPS,ROHM,Xilinx,Pulse,ON,Everlight and Freescale. Main products comprise IC,Modules,Potentiometer,IC Socket,Relay,Connector.Our parts cover such applications as commercial,industrial, and automotives areas.

We are looking forward to setting up business relationship with you and hope to provide you with the best service and solution. Let us make a better world for our industry!



Contact us

Tel: +86-755-8981 8866 Fax: +86-755-8427 6832

Email & Skype: info@chipsmall.com Web: www.chipsmall.com

Address: A1208, Overseas Decoration Building, #122 Zhenhua RD., Futian, Shenzhen, China



INSTRUCTION MANUAL MANUAL DE INSTRUCCIONES MANUEL D'INSTRUCTIONS



GREENLEE®

A Textron Company

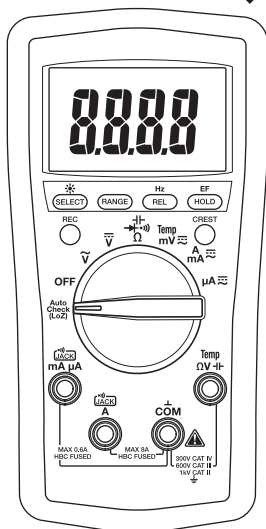

DM-200A • DM-210A DM-510A

Digital Multimeters Multímetros digitales Multimètres numériques

Read and understand all of the instructions and safety information in this manual before operating or servicing this tool.

Lea y entienda todas las instrucciones y la información sobre seguridad que aparecen en este manual, antes de manejar estas herramientas o darles mantenimiento.

Lire attentivement et bien comprendre toutes les instructions et les informations sur la sécurité de ce manuel avant d'utiliser ou de procéder à l'entretien de cet outil.



Register this product at www.greenlee.com / Registre este producto en www.greenlee.com
Enregistrez votre produit en ligne, www.greenlee.com

Description

The Greenlee DM-200A, DM-210A, and DM-510A Digital Multimeters are hand-held testing devices with the following measurement capabilities: AC and DC voltage, AC and DC current, frequency, and resistance. They also check diodes and verify continuity. An optional optically isolated computer interface with software facilitates the recording of readings from the meter to a computer.

Other specialized capabilities and functions common to all meters include:

- Backlighted LCD for reading in dim conditions.
- Beep-Jack™ audible warning alerts the user with a beep and an error message on the LCD if the test lead is plugged into the **mA/μA** or **A** input terminal while the selector switch is not in the **mA/μA** or **A** position.
- Non-contact and single-probe voltage detection capability.
- Bar graph display, which responds more quickly than the numeric display — useful for detecting faulty contacts, potentiometer clicks, and signal spikes.
- Relative zero mode.
- Data hold mode.
- Selectable automatic power off.

The DM-210A and DM-510A multimeters have the following additional capabilities: temperature (K-type thermocouples only) and capacitance.

The DM-510A multimeter has an AutoCheck™ function for automatic selection of AC voltage, DC voltage, and resistance with low input impedance to mask “ghost” voltages. The DM-510A also has a crest function, which captures voltage or current signal peaks, as well as a recording function, which stores the maximum and minimum input readings. The DM-510A is a true RMS meter.

Safety

Safety is essential in the use and maintenance of Greenlee tools and equipment. This instruction manual and any markings on the tool provide information for avoiding hazards and unsafe practices related to the use of this tool. Observe all of the safety information provided.

Purpose of This Manual

This instruction manual is intended to familiarize all personnel with the safe operation and maintenance procedures for the Greenlee DM-200A, DM-210A, and DM-510A Digital Multimeters

Keep this manual available to all personnel. Replacement manuals are available upon request at no charge at www.greenlee.com.



Do not discard this product or throw away!

For recycling information, go to www.greenlee.com.

Important Safety Information



SAFETY ALERT SYMBOL

This symbol is used to call your attention to hazards or unsafe practices which could result in an injury or property damage. The signal word, defined below, indicates the severity of the hazard. The message after the signal word provides information for preventing or avoiding the hazard.

DANGER

Immediate hazards which, if not avoided, **WILL** result in severe injury or death.

WARNING

Hazards which, if not avoided, **COULD** result in severe injury or death.

CAUTION

Hazards or unsafe practices which, if not avoided, **MAY** result in injury or property damage.



WARNING

Read and understand this material before operating or servicing this equipment. Failure to understand how to safely operate this tool could result in an accident causing serious injury or death.



WARNING

Electric shock hazard:
Contact with live circuits could result in severe injury or death.

All specifications are nominal and may change as design improvements occur. Greenlee Textron Inc. shall not be liable for damages resulting from misapplication or misuse of its products.

© Registered: The color green for electrical test instruments is a registered trademark of Textron Innovations Inc.

AutoCheck and Beep-Jack are trademarks of BTC.

Microsoft and Windows are registered trademarks of Microsoft Corporation.

KEEP THIS MANUAL

Important Safety Information

WARNING

Electric shock and fire hazard:

- Do not expose this unit to rain or moisture.
- Do not use the unit if it is wet or damaged.
- Use test leads or accessories that are appropriate for the application. Refer to the category and voltage rating of the test lead or accessory.
- Inspect the test leads or accessory before use. They must be clean and dry, and the insulation must be in good condition.
- Use this unit for the manufacturer's intended purpose only, as described in this manual. Any other use can impair the protection provided by the unit.

Failure to observe these warnings could result in severe injury or death.

WARNING

Electric shock hazard:

- Do not apply more than the rated voltage between any two input terminals, or between any input terminal and earth ground.
- Do not contact the test lead tips or any uninsulated portion of the accessory.

Failure to observe these warnings could result in severe injury or death.

WARNING

Electric shock hazard:

- Do not operate with the case open.
- Before opening the case, remove the test leads from the circuit and shut off the unit.

Failure to observe these warnings could result in severe injury or death.

WARNING

Electric shock hazard:

The fuses are an integral part of the overvoltage protection. When fuse replacement is necessary, refer to "Specifications" for the correct type, size, and capacity. Using any other type of fuse will void the overvoltage protection rating of the unit.

Failure to observe this warning could result in severe injury or death.

Important Safety Information

WARNING

Electric shock hazard:

- Unless measuring voltage, current, or frequency, shut off and lock out power. Make sure that all capacitors are discharged. Voltage must not be present.
- Set the selector and connect the test leads so that they correspond to the intended measurement. Incorrect settings or connections can result in a blown fuse.
- Using this unit near equipment that generates electromagnetic interference can result in unstable or inaccurate readings.

Failure to observe these warnings could result in severe injury or death.

CAUTION

Electric shock hazard:

Do not change the measurement function while the test leads are connected to a component or circuit.

Failure to observe this precaution may result in injury and can damage the unit.

CAUTION

Electric shock hazard:

Do not use the tester to measure voltages in circuits that could be damaged or activated by the AutoCheck™ mode's low input impedance (approximately 2.5 k Ω and 120 pF).

Failure to observe this precaution may result in injury and can damage the unit.

CAUTION

Electric shock hazard:

- Do not attempt to repair this unit. It contains no user-serviceable parts.
- Do not expose the unit to extremes in temperature or high humidity. Refer to "Specifications."





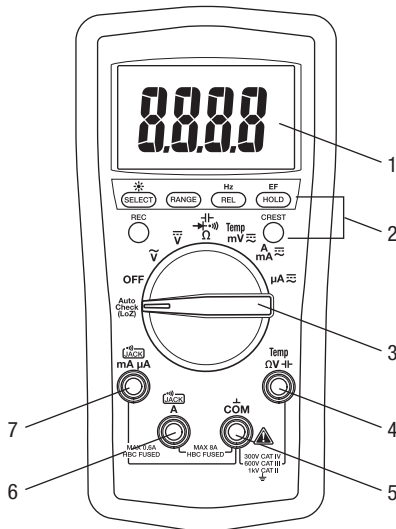

Failure to observe these precautions may result in injury and can damage the unit.

Identification

- | | |
|--------------------------------|--|
| 1. Display | 4-digit LCD (maximum reading is 5999) and bar graph. |
| 2. Feature buttons | Refer to explanations in the “Using the Features” section. |
| 3. Selector | Selects a function or turns power OFF. |
| 4. Ω ∇ \vdash | Positive input terminal for all measurements except current. |
| 5. COM | Negative, common, or ground input terminal for all measurements. |
| 6. A | Positive input terminal for high current measurements. |
| 7. mA μA | Positive input terminal for low current measurements. |



Display Icons

13. 	Bar graph element	27. M	Mega (10^6)
14. -	Polarity indicator for bar graph	28. Ω	Ohm
15. LoZ	Low input impedance is active.	29. k	Kilo (10^3)
16. 	Low battery	30. Hz	Hertz (frequency in cycles per second)
17. -	Polarity indicator	31. n	Nano (10^{-9})
18. 8.8.8.8	Numeric display	32. F	Farad
19. Δ	Relative zero function is enabled.	33. μ	Micro (10^{-6})
20. 	AC measurement is selected.	34. m	Milli (10^{-3})
21. 	DC measurement is selected.	35. V	Volt
22. AUTO	Automatic ranging is enabled.	36. A	Ampere
23. 	Continuity	37. 	Bar graph scale
24. H	Hold function is enabled.	38. 	Overload (bar graph display)
25. C	Crest capture function is enabled.		
26. MAX	Maximum is displayed or being recorded.		
MIN	Minimum is displayed or being recorded.		

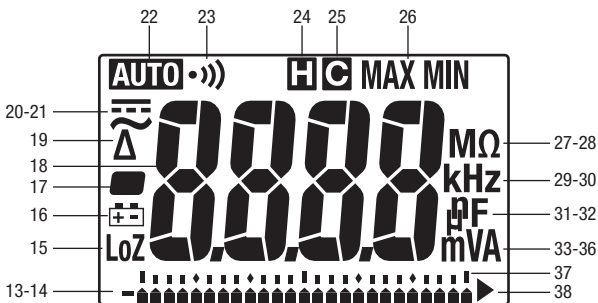

Using the Features

All Models

- **SELECT**: Press momentarily to toggle between functions.
- : Press and hold until backlight illuminates. Press and hold again to turn off. The backlight automatically turns off after approximately 30 seconds to extend battery life.
- **RANGE**: Press once to enter the manual ranging mode. The **AUTO** icon will disappear from the display. Press repeatedly to step through the ranges. Press and hold to return to the automatic ranging mode.

*Note: When using MAX/MIN, HOLD, or Δ mode, pressing **RANGE** will cause the meter to exit that mode.*

- **REL**: Finds the difference between two measurements. While taking a measurement, press **REL** to set the display to zero. The Δ icon will appear on the display. Take the second measurement. The value on the display will be the difference between the two measurements. Press again to exit this mode.
- **Hz**: Press and hold until the meter beeps to enable frequency measurement. The frequency function can be used with the selector in any voltage or current setting. Use the **V** or **A** settings for measuring the frequency of sinusoidal waveforms. Use the **mV** setting for measuring the frequency of 3 volt or 5 volt logic level, square waveform signals.

The sensitivity of the frequency measurement function varies with the measurement range. To automatically select a sensitivity level, measure the voltage or current first, and then press **Hz**. If the reading becomes unstable or reads zero, press the **RANGE** button to select a different sensitivity level.

The number of bar graph elements indicates the sensitivity selected:

- 1 element = 6 V, 6 A, 60 mA, or 600 μ A
 - 2 elements = 60 V, 10 A, 600 mA, or 6000 μ A
 - 3 elements = 600 V
 - 4 elements = 1000 V
- **HOLD** : Press momentarily to hold the present value on the display. Press again to exit this mode.
This feature does not affect the bar graph.
 - **EF**: Set the meter to any current or voltage function. Press and hold until the meter beeps to detect the electric field that surrounds current-carrying conductors. Signal strength is displayed as a series of dashes on the display.
 - Use the tester's built-in antenna (located along the top, near the LCD) for tracing live circuits or locating a break in a wire.
 - For more precision, such as distinguishing between current-carrying and ground wires, connect a test lead to the **Ω V** input terminal and use it as a probe for direct contact verification of AC voltage.
 - **Automatic Power Off**: To extend battery life, the meter will shut itself off after approximately 30 minutes of inactivity. To restore power, press either the **SELECT**, **CREST**, or **REC** button or turn the selector to **OFF** and then back on. To disable this feature, press **SELECT** while turning the meter on.

Using the Features (cont'd)

- **Disabling the Beeper:** Hold down the **RANGE** button while turning the meter on to temporarily disable the beeper feature. Turn the selector to **OFF** and then back on to enable the beeper.

DM-510A Only

- **Low Impedance AutoCheck™ Mode:** In this mode, the meter automatically selects the proper measurement based on the input.
 - If there is no input, “Auto” appears on the display.
 - If the voltage is above approximately 1 volt AC or DC, voltage is displayed.
 - If both AC and DC voltages are present, the larger voltage is displayed.
 - If no voltage is present and there is resistance less than approximately 10 M Ω , resistance is displayed. If the measured resistance is below the continuity threshold (between 10 Ω and 80 Ω), then the continuity tone will sound.

This mode features low input impedance to mask stray or “ghost” voltage pickup. The input impedance is approximately 2.5 k Ω at low voltage, increasing to approximately 375 k Ω at 1000 V.

The symbol “LoZ” indicates that the meter is in a low impedance mode. Do not use the AutoCheck™ mode on circuits that could be damaged or activated by such low input impedance. Instead use the selector to select the high impedance AC or DC volts modes to minimize loading for such circuits.

Range-Lock and Function Feature: While in the AutoCheck™ mode, press the **SELECT** button momentarily to lock the displayed function. Press the **RANGE** button momentarily to lock the displayed measurement range. Press either button repeatedly to step through the ranges or functions.

Energized Circuit Alert: If the resistance mode is locked in the AutoCheck™ mode and the leads are placed across an energized circuit, the meter will emit an audible warning tone.

- **REC:** Press momentarily to activate the MAX/MIN recording mode. The input value is measured every 50 ms in this mode. “MAX MIN” will appear on the display. The LCD will display the actual input value. The meter will beep whenever the maximum or minimum is updated. Press repeatedly to select the desired display: maximum, minimum, or actual input. Press and hold to exit this mode.

The automatic power off feature is disabled when using this function.

- **CREST:** Press momentarily to activate the crest recording mode. The input value is measured every 5 ms in this mode. **C** and “MAX” will appear on the display. The LCD will display the maximum crest value. Press repeatedly to select the desired display: maximum or minimum crest value. Press and hold to exit this mode.

Automatic ranging and automatic power off are disabled when using this function.

AC Measurement



AC measurements are usually displayed as RMS (root mean square) values. The RMS value is equal to the value of a DC waveform, which would deliver the same power if it replaced the time-varying waveform. Two AC measurement methods are average-responding RMS calibrated and true RMS-reading.

The average-responding RMS calibrated method takes the average value of the input signal after full wave rectification, multiplies it by 1.11, and displays the result. This method is accurate if the input signal is a pure sine wave. The DM-200A and DM-210A are average-responding meters.

The true RMS-reading method uses internal circuitry to read the true RMS value. This method is accurate, within the specified crest factor limitations, whether the input signal is a pure sine wave, square wave, triangle wave, half wave, or signal with harmonics. The ability to read true RMS provides much more measurement versatility. The DM-510A is a true RMS meter.

The Waveforms and Crest Factors table shows some typical AC signals and their RMS values.

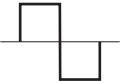
Waveforms and Crest Factors

Waveform				
RMS Value	100	100	100	100
Average Value	90	100	87	64
Crest Factor* (ξ)	1.414	1	1.73	2

* The crest factor is the ratio of the peak value to the RMS value; it is represented by the Greek letter ξ .

Using the Optional Software

These meters are compatible with Greenlee DMSC-2U, an optically isolated computer interface cable and software. It allows measurements to be logged to a personal computer using the Microsoft® Windows® operating system.



Installing the Software

1. Insert the CD into the computer's CDROM drive.
2. The installation program should launch automatically. If it does not, double click on the CD icon in "My Computer."
3. The installation program menu will appear. Click on "Software Installation."
4. Type your meter's catalog number (for example, "DM-510A") in the dialog box.
5. Complete the remaining dialog boxes according to user preferences.
6. Refer to the program's Readme file for instructions on using the software.

Connecting the Optical Interface Cable









1. Align the interface with the slot on the back of the meter. The cable must point to the left.
2. Push the interface into the slot.
3. For USB applications, proceed to step 5.
4. For RS-232 applications, connect the interface cable to a serial port on the computer, and proceed to step 8.
5. Connect the interface cable to the RS-232-to-USB adapter supplied with DMSC-2U.
6. Connect the square end of the USB cable to the RS-232-to-USB adapter.
7. Connect the other end of the USB cable to the computer.
8. Press the **HOLD** button while turning the meter on to enable its communication capabilities.

Operation

	⚠ WARNING
	<p>Electric shock hazard: Contact with live circuits could result in severe injury or death.</p>

1. Refer to the Settings Table. Set the selector to the proper setting, press **SELECT** (when instructed to do so), and connect the test leads to the meter.
2. Refer to “Typical Measurements” for specific measurement instructions.
3. Test the unit on a known functioning circuit or component.
 - If the unit does not function as expected on a known functioning circuit, replace the battery and/or fuses.
 - If the unit still does not function as expected, call Greenlee for technical assistance at 800-435-0786.
4. Take the reading from the circuit or component to be tested.







Settings Table

To measure this characteristic ...	Set the selector to this symbol ...	These icons will appear on the display ...	Connect the red lead to ...	Connect the black lead to ...
All Models				
Voltage (1000 V max)		~ and V	ΩV	COM
		= and V		
Resistance	  and press SELECT	MΩ	ΩV	COM
Continuity*		•••) and Ω		
Diode		diod (momentarily) and V		
Voltage (600 mV max)**	mV 	mV	ΩV	COM
Current (8 A max)**	A mA 	AUTO A, = or ~	A	COM
Current (600 mA max)**	A mA 	AUTO mA, = or ~	mA μA	COM
Current (6000 μA max)**	μA 	AUTO μA, = or ~	mA μA	COM

This table continues on the next page.

Operation (cont'd)

Settings Table (cont'd)

To measure this characteristic ...	Set the selector to this symbol ...	These icons will appear on the display ...	Connect the red lead to ...	Connect the black lead to ...
All Models (cont'd)				
Frequency—Line Level Voltage or Current	 , A, mA, or μ A and press Hz	Hz	Ω V	COM
Frequency—Logic Level***	mV and press Hz	Hz	Ω V	COM
EF single probe†	Any voltage or current function and press EF for at least 1 second	E.F.	Ω V	—
EF non-contact†			—	—
DM-210A and DM-510A Only				
Capacitance††	 Ω and press SELECT	AUTO nF	Temp Ω V 	COM
Temperature	Temp	C or F (press SELECT to change scale)	Temp Ω V 	COM
DM-510A Only				
Auto select AC volts, DC volts, resistance, and continuity (low impedance measurement)	AutoCheck	 and LoZ	Temp Ω V 	COM

* Tone indicates continuity. The threshold is between 10 Ω and 80 Ω .

** Press **SELECT** for AC or DC, as required.

*** Logic level frequency has a fixed sensitivity and is for digital signals. Refer to “Accuracy”.

† Refer to the “Using the Features” section for an explanation of EF (electric field detection).

†† Discharge capacitor before measurement. Discharge a large capacitor through an appropriate resistive load.

Typical Measurements

Voltage Measurement

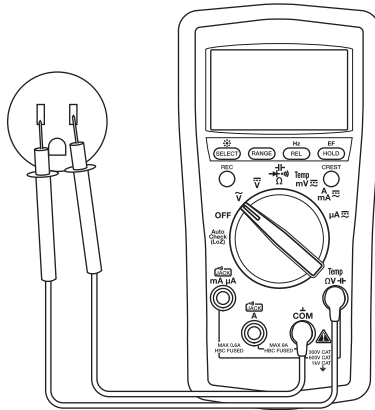

Current Measurement

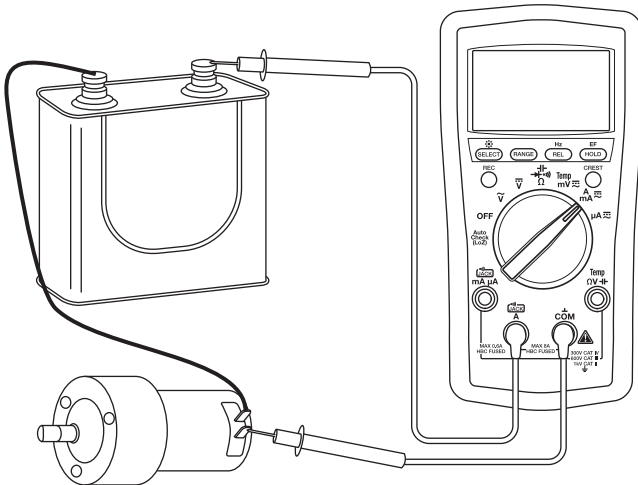

Typical Measurements

Resistance Measurement

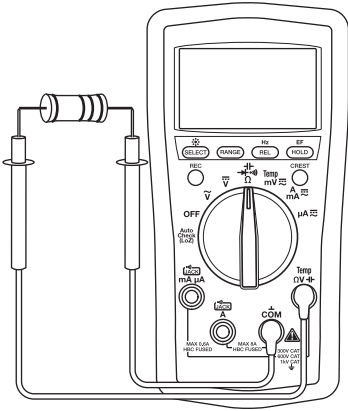

Continuity Check

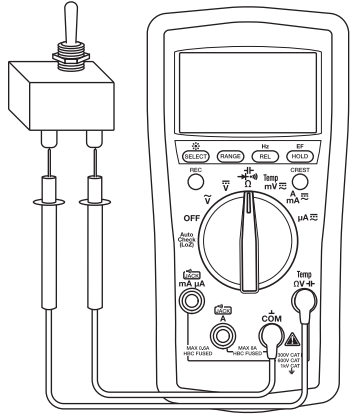

Capacitance Measurement

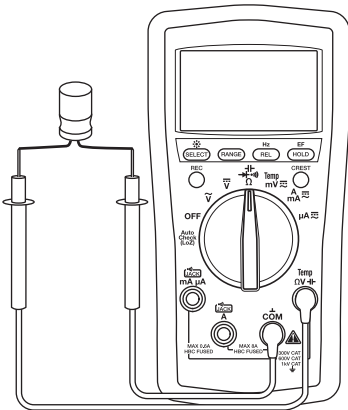

Diode Measurement

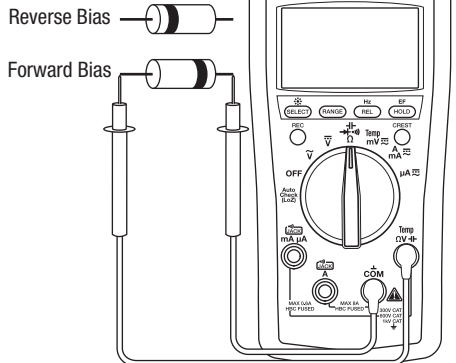

Typical Measurements

Temperature

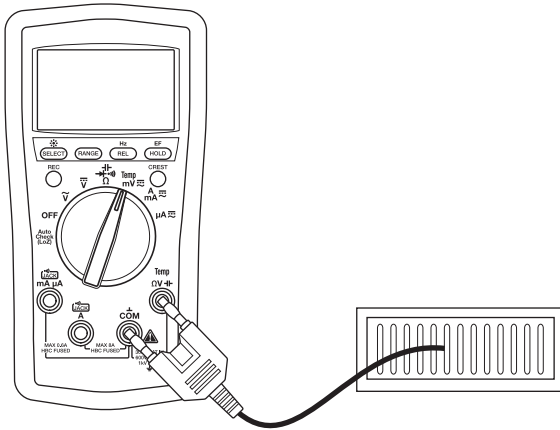

Electric Field Detection (EF)

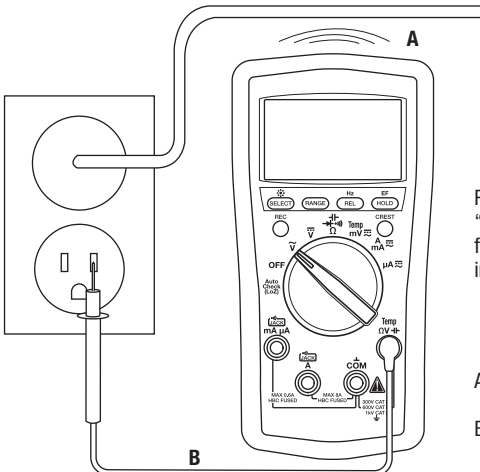

Refer to
"Using the Features"
for complete
instructions.

A—Non-contact
OR
B—Contact

Accuracy

Refer to the “Specifications” section for operating conditions and temperature coefficient.

Accuracy is specified as follows: \pm (a percentage of the reading + a fixed amount) at $23\text{ }^{\circ}\text{C} \pm 5\text{ }^{\circ}\text{C}$ ($73.4\text{ }^{\circ}\text{F} \pm 9\text{ }^{\circ}\text{F}$), 0% to 75% relative humidity.

True RMS Readings: DM-510A AC accuracies are specified from 5% to 100% of the range unless otherwise specified. Frequency must be within the specified bandwidth for non-sinusoidal waveforms. Crest factors are as follows:

- Crest factor < 3:1 at full scale
- Crest factor < 6:1 at half scale

All Models

AC Voltage

Range (50 Hz to 400 Hz)	Accuracy
60.00 mV	$\pm (1.0\% + 0.05\text{ mV})$
600.0 mV	$\pm (1.0\% + 0.5\text{ mV})$
6.000 V	$\pm (1.0\% + 0.005\text{ V})$
60.00 V	$\pm (1.0\% + 0.05\text{ V})$
600.0 V	$\pm (1.0\% + 0.5\text{ V})$
1000 V	$\pm (1.0\% + 5\text{ V})$

Input Impedance: 10 M Ω // 50 pF

Accuracies for DM-510A are specified from 5% to 100% of range

Resistance

Range	Accuracy
600.0 Ω	$\pm (0.5\% + 0.4\text{ } \Omega)$
6.000 k Ω	$\pm (0.5\% + 0.004\text{ k}\Omega)$
60.00 k Ω	$\pm (0.5\% + 0.04\text{ k}\Omega)$
600.0 k Ω	$\pm (0.5\% + 0.4\text{ k}\Omega)$
6.000 M Ω	$\pm (0.7\% + 0.004\text{ M}\Omega)$
60.00 M Ω	$\pm (1.2\% + 0.04\text{ M}\Omega)$

Open Circuit Voltage: 0.45 VDC typical

DC Voltage

Range	Accuracy
60.00 mV	$\pm (0.4\% + 0.05\text{ mV})$
600.0 mV	$\pm (0.2\% + 0.3\text{ mV})$
6.000 V	$\pm (0.2\% + 0.003\text{ V})$
60.00 V	$\pm (0.2\% + 0.03\text{ V})$
600.0 V	$\pm (0.2\% + 0.3\text{ V})$
1000 V	$\pm (0.2\% + 3\text{ V})$

Input Impedance: 10 M Ω // 50 pF

Diode Test

Measuring Range: 1.000 V

Test Current (typical): 0.56 mA

Open Circuit Voltage: < 1.8 VDC

Accuracy: $\pm (1.0\% + 0.003\text{ V})$

Continuity

Tone Threshold: Between 10 Ω and 80 Ω

Response Time: < 32 ms

Accuracy (cont'd)

All Models (cont'd)

AC Current

Range (50 Hz to 400 Hz)	Accuracy	Burden Voltage (typical)
600.0 μ A	\pm (1.0% + 0.3 μ A)	0.1 mV/ μ A
6000 μ A	\pm (1.0% + 3 μ A)	
60.00 mA	\pm (1.0% + 0.03 mA)	1.7 mV/mA
600.0 mA	\pm (1.0% + 0.3 mA)	
6.000 A	\pm (1.2% + 0.006 A)	0.03 V/A
8.00 A*	\pm (1.8% + 0.006 A)	

Accuracies for DM-510A are specified from 5% to 100% of range

* 8 A continuous, > 8 A to 15 A for 30 second max with 5 minutes cool down interval

DC Current

Range	Accuracy	Burden Voltage (typical)
600.0 μ A	\pm (0.5% + 0.5 μ A)	0.1 mV/ μ A
6000 μ A	\pm (0.5% + 3 μ A)	
60.00 mA	\pm (0.5% + 0.05 mA)	1.7 mV/mA
600.0 mA	\pm (0.5% + 0.3 mA)	
6.000 A	\pm (1.2% + 0.006 A)	0.03 V/A
8.00 A*	\pm (1.8% + 0.006 A)	

* 8 A continuous, > 8 A to 15 A for 30 second max with 5 minutes cool down interval

Frequency—Hz (Line) at ACV, DCV, Current, AutoCheck™ Mode

Function	Sensitivity (Sine RMS)	Range
6 V	0.4 V	10 Hz to 10 kHz
60 V	4 V	10 Hz to 50 kHz
600 V	40 V	10 Hz to 50 kHz
1000 V	400 V	45 Hz to 1 kHz
600 μ A	40 μ A	10 Hz to 10 kHz
6000 μ A	400 μ A	10 Hz to 10 kHz
60 mA	4 mA	10 Hz to 10 kHz
600 mA	40 mA	10 Hz to 10 kHz
6 A	1 A	10 Hz to 1 kHz
10 A	6 A	10 Hz to 1 kHz

Accuracy (cont'd)

All Models (cont'd)

Accuracy of Frequency Ranges

Display Range	Accuracy
10.00 Hz to 65.53 Hz	$\pm (0.03\% + 0.03 \text{ Hz})$
65.5 Hz to 655.3 Hz	$\pm (0.03\% + 0.3 \text{ Hz})$
0.655 kHz to 6.553 kHz	$\pm (0.03\% + 0.003 \text{ kHz})$
6.55 kHz to 50.00 kHz	$\pm (0.03\% + 0.03 \text{ kHz})$

Frequency—Logic Level Hz (mV Function)

Range	Accuracy	Sensitivity (square wave)
5.0 Hz to 6.553 Hz	$\pm (0.03\% + 0.002 \text{ Hz})$	3 V peak
6.55 Hz to 65.53 Hz	$\pm (0.03\% + 0.02 \text{ Hz})$	
65.5 Hz to 655.3 Hz	$\pm (0.03\% + 0.2 \text{ Hz})$	
0.655 kHz to 6.553 kHz	$\pm (0.03\% + 0.002 \text{ kHz})$	
6.55 kHz to 65.53 kHz	$\pm (0.03\% + 0.02 \text{ kHz})$	
65.5 kHz to 500.0 kHz	$\pm (0.03\% + 0.2 \text{ kHz})$	5 V peak
500.0 kHz to 655.3 kHz	$\pm (0.03\% + 0.2 \text{ kHz})$	
0.655 MHz to 1.000 MHz	$\pm (0.03\% + 0.002 \text{ MHz})$	

Non-contact Electric Field Detection (EF)

Typical Voltage	Bar Graph Indication*	Frequency Range
10 V to 36 V	—	50 Hz to 60 Hz
23 V to 83 V	--	
59 V to 165 V	---	
124 V to 330 V	----	
250 V to 1000 V	-----	

* Bar graph indication and tone are proportional to signal strength

Accuracy (cont'd)

DM-210A and DM-510A Only

Capacitance

Range	Accuracy
60.00 nF	$\pm (2.0\% + 0.05 \text{ nF})$
600.0 nF	$\pm (2.0\% + 0.5 \text{ nF})$
6.000 μF	$\pm (1.5\% + 0.005 \mu\text{F})$
60.00 μF	$\pm (1.5\% + 0.05 \mu\text{F})$
600.0 μF	$\pm (1.5\% + 0.5 \mu\text{F})$
3000 μF	$\pm (2.0\% + 5 \mu\text{F})$

Accuracies are for film capacitors (capacitors with negligible dielectric absorption); measurements of larger capacitors can take up to 30 seconds

DM-510A Only

AC Voltage AutoCheck™ Mode

Range (50/60 Hz)	Accuracy
6.000 V	$\pm (1.4\% + 0.005 \text{ V})$
60.00 V	$\pm (1.4\% + 0.05 \text{ V})$
600.0 V	$\pm (1.4\% + 0.5 \text{ V})$
1000 V	$\pm (1.4\% + 5 \text{ V})$

Input Impedance: Initial 2.5 k Ω // 120 pF typical at voltages up to 50 V; increases with voltage to approximately 375 k Ω at 1000 V
AutoCheck™ Trigger Level: > 1.0 V (50/60 Hz) typical

Resistance AutoCheck™ Mode

Range	Accuracy
600.0 Ω	$\pm (1.2\% + 1.0 \Omega)$
6.000 k Ω	$\pm (1.2\% + 0.010 \text{ k}\Omega)$
60.00 k Ω	$\pm (1.2\% + 0.10 \text{ k}\Omega)$
600.0 k Ω	$\pm (1.2\% + 1.0 \text{ k}\Omega)$
6.000 M Ω	$\pm (1.2\% + 0.010 \text{ M}\Omega)$
60.00 M Ω	$\pm (1.2\% + 0.10 \text{ M}\Omega)$

Open Circuit Voltage: 0.45 VDC typical
AutoCheck™ Trigger Level: < 10.00 M Ω typical

Temperature

Range	Accuracy
-50 °C to 1000 °C	$\pm (0.3\% + 3 \text{ °C})$
-58 °F to 1832 °F	$\pm (0.3\% + 6 \text{ °F})$

The accuracy information is for the meter only; refer to the information sheet provided with the temperature probe (purchased separately) for its accuracy

DC Voltage AutoCheck™ Mode

Range	Accuracy
6.000 V	$\pm (1.3\% + 0.003 \text{ V})$
60.00 V	$\pm (1.3\% + 0.03 \text{ V})$
600.0 V	$\pm (1.3\% + 0.3 \text{ V})$
1000 V	$\pm (1.3\% + 3 \text{ V})$

Input Impedance: Initial 2.5 k Ω // 120 pF typical at voltages up to 50 V; increases with voltage to approximately 375 k Ω at 1000 V
AutoCheck™ Trigger Level: > +1.0 VDC and < -1.0 VDC typical

Record Mode (Voltage and Current) for recording signal maximums and minimums $\geq 100 \text{ ms}$ in duration

Accuracy: Specified accuracy + 100 digits

Crest Capture (Voltage and Current) for Crests $\geq 5 \text{ ms}$ in duration

Accuracy: Specified accuracy ± 150 digits

Specifications

Display: LCD (6000) and 24-segment bar graph

Polarity: Automatic

Sampling Rate:

Numeric Display: 5 per second

Bar Graph Display: 40 per second

Temperature Coefficient: Nominal 0.15 x (specified accuracy) per °C
below 18 °C or above 28 °C

Automatic Power Off: After 34 minutes of inactivity.

To disable this feature, press **SELECT** while turning the meter on.

Noise Rejection*:

Normal Mode Rejection Ratio > 60 dB at 50 Hz and 60 Hz when measuring DCV

Common Mode Rejection Ratio > 60 dB from 0 Hz to 60 Hz when measuring ACV

Common Mode Rejection Ratio > 100 dB at 0 Hz, 50 Hz and 60 Hz when measuring DCV

Operating Conditions:

Temperature: 0 °C to 40 °C (32 °F to 104 °F)

Relative Humidity (non-condensing): 80% maximum for temperatures up to 31 °C (88 °F),
decreasing linearly to 50% maximum at 40 °C (104 °F)

Altitude: 2000 m (6500') maximum

Indoor use only

Pollution Degree: 2

Storage Conditions:

Temperature: -20 °C to 60 °C (-4 °F to 140 °F)

Relative Humidity (non-condensing): 0% to 80%

Remove battery.

Battery: Two 1.5 V batteries (AAA, NEDA 24A or IEC LR03)

Overload Protections:

Volts: 1050 V RMS, 1450 V peak

AutoCheck™, mV, Ω, and Others: 600 V RMS

µA and mA: 0.63 A/500 V fuse, interrupting rating 50 kA, 1/4" x 1-1/4"

A: 10 A/600 V fuse, interrupting rating 100 kA, 13/32" x 1-1/2"

Overvoltage Categories:

Ω $\frac{V}{I}$ Terminal: Category II 1000 V, Category III 600 V, and Category IV 300 V AC and DC

µA and mA Terminal: Category III 500 VAC and 300 VDC

A Terminal: Category III 600 VAC and 300 VDC

E.M.C: Meets EN61326-1:2006 (EN55022, EN61000-3-2, EN61000-3-3, EN61000-4-2, EN61000-4-3, EN61000-4-4, EN61000-4-5, EN61000-4-6, EN61000-4-8, EN61000-4-11)

*Noise rejection is the ability to reject unwanted signals, or noise.

- *Normal mode voltages* are AC signals that can cause inaccurate DC measurements. NMRR (Normal Mode Rejection Ratio) is a measure of the ability to filter out these signals.
- *Common mode voltages* are signals present at the COM and + input terminals, with respect to ground, that can cause digit rattle or offset in voltage measurements. CMRR (Common Mode Rejection Ratio) is a measure of the ability to filter out these signals.

Measurement Categories

These definitions were derived from the international safety standard for insulation coordination as it applies to measurement, control, and laboratory equipment. These measurement categories are explained in more detail by the International Electrotechnical Commission; refer to either of their publications: IEC 61010-1 or IEC 60664.

Measurement Category I

Signal level. Electronic and telecommunication equipment, or parts thereof. Some examples include transient-protected electronic circuits inside photocopiers and modems.

Measurement Category II

Local level. Appliances, portable equipment, and the circuits they are plugged into. Some examples include light fixtures, televisions, and long branch circuits.

Measurement Category III

Distribution level. Permanently installed machines and the circuits they are hard-wired to. Some examples include conveyor systems and the main circuit breaker panels of a building's electrical system.

Measurement Category IV

Primary supply level. Overhead lines and other cable systems. Some examples include cables, meters, transformers, and other exterior equipment owned by the power utility.

Statement of Conformity

Greenlee Textron Inc. is certified in accordance with ISO 9001 (2000) for our Quality Management Systems.

The instrument enclosed has been checked and/or calibrated using equipment that is traceable to the National Institute for Standards and Technology (NIST).

Maintenance

⚠ WARNING

Electric shock hazard:

Before opening the case, remove the test leads from the circuit and shut off the unit.

Failure to observe these warnings could result in severe injury or death.

⚠ WARNING

Electric shock hazard:

The fuses are an integral part of the overvoltage protection. When fuse replacement is necessary, refer to "Specifications" for the correct type, size, and capacity. Using any other type of fuse will void the overvoltage protection rating of the unit.

Failure to observe this warning could result in severe injury or death.

Replacing the Battery and Fuses

1. Disconnect the unit from the circuit. Turn the unit OFF.
2. Remove the rubber boot.
3. Remove the screw from the back cover.
4. Remove the back cover.
5. Replace and batteries (observe polarity) and/or fuse(s).
6. Replace the cover, screw, and rubber boot.

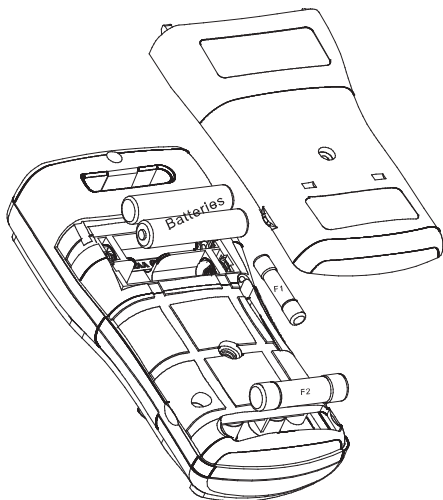

Cleaning

Periodically wipe the case with a damp cloth and mild detergent; do not use abrasives or solvents.



GREENLEE.

Descripción

Los multímetros digitales Greenlee DM-200A, DM-210A y DM-510A, son instrumentos de verificación manuales que poseen las capacidades de medición siguientes: Voltaje de CA y CC, corriente de CA y CC, frecuencia y resistencia. También sirven para verificar diodos y continuidad. Una interfaz opcional de ordenador ópticamente aislada y software facilitan la grabación de lecturas del medidor a un ordenador.

Entre otras capacidades y funciones especializadas, comunes a todos los medidores, se incluyen:

- Pantalla de LCD con luz de fondo que facilita la lectura en condiciones de iluminación tenue.
- La función Beep-Jack™ que le advierte al usuario, mediante un tono audible y un mensaje de error en la pantalla LCD, si el cable de prueba se encuentra conectado a una terminal de entrada **mA/μA** o **A** mientras el interruptor de selección no se halla en la posición **mA/μA** o **A**.
- Incluye además la capacidad de detectar voltaje sin contacto y con una sonda.
- Pantalla de gráfico de barras, la cual responde más rápidamente que la pantalla numérica; útil para detectar fallas en contactos, potenciómetros y picos de señal.
- Modo de cero relativo.
- Modo de retención de datos en pantalla.
- Apagado automático seleccionable.

Los multímetros DM-210A y DM-510A tienen además las siguientes características: temperatura (solamente para termopares tipo K) y capacitancia.

El multímetro DM-510A tienen una función AutoCheck™ para la selección automática de voltaje de CA, voltaje de CC, y resistencia con impedancia baja de entrada para enmascarar voltajes "falsos". El modelo DM-510A posee además una función de cresta que captura picos de señales de voltaje o de corriente; y una función de grabación que almacena las lecturas de entradas máximas y mínimas. El modelo DM-510A es un medidor de valores eficaces (RMS) reales.

Acerca de la seguridad

Es fundamental observar métodos seguros al utilizar y dar mantenimiento a las herramientas y equipo Greenlee. Este manual de instrucciones y todas las marcas que ostenta la herramienta le ofrecen la información necesaria para evitar riesgos y hábitos poco seguros relacionados con su uso. Siga toda la información sobre seguridad que se proporciona.

Propósito de este manual

Este manual de instrucciones tiene como propósito familiarizar a todo el personal con los procedimientos de operación y mantenimiento seguros para los Multímetros digitales modelos DM-200A, DM-210A, y DM-510A de Greenlee.

Manténgalo siempre al alcance de todo el personal. Puede obtener copias adicionales de manera gratuita, previa solicitud en www.greenlee.com.



¡No deseche ni descarte este producto!

Para información sobre reciclaje, visite www.greenlee.com.