



Chipsmall Limited consists of a professional team with an average of over 10 year of expertise in the distribution of electronic components. Based in Hongkong, we have already established firm and mutual-benefit business relationships with customers from,Europe,America and south Asia,supplying obsolete and hard-to-find components to meet their specific needs.

With the principle of “Quality Parts,Customers Priority,Honest Operation,and Considerate Service”,our business mainly focus on the distribution of electronic components. Line cards we deal with include Microchip,ALPS,ROHM,Xilinx,Pulse,ON,Everlight and Freescale. Main products comprise IC,Modules,Potentiometer,IC Socket,Relay,Connector.Our parts cover such applications as commercial,industrial, and automotives areas.

We are looking forward to setting up business relationship with you and hope to provide you with the best service and solution. Let us make a better world for our industry!



## Contact us

Tel: +86-755-8981 8866 Fax: +86-755-8427 6832

Email & Skype: info@chipsmall.com Web: www.chipsmall.com

Address: A1208, Overseas Decoration Building, #122 Zhenhua RD., Futian, Shenzhen, China



# INSTRUCTION MANUAL MANUAL DE INSTRUCCIONES MANUEL D'INSTRUCTIONS



## GREENLEE®

A Textron Company

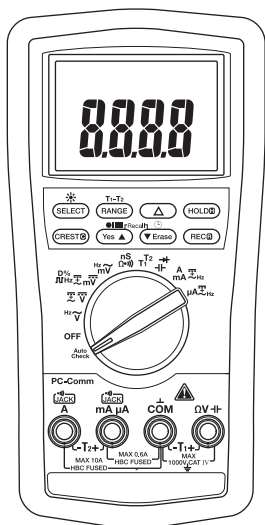

## DM-810A • DM-820A DM-830A • DML-430A

### Digital Multimeters

### Multímetros digitales

### Multimètres numériques



**Read and understand** all of the instructions and safety information in this manual before operating or servicing this tool.

**Lea y entienda** todas las instrucciones y la información sobre seguridad que aparecen en este manual, antes de manejar estas herramientas o darles mantenimiento.

**Lire attentivement et bien comprendre** toutes les instructions et les informations sur la sécurité de ce manuel avant d'utiliser ou de procéder à l'entretien de cet outil.

Register this product at [www.greenlee.com](http://www.greenlee.com) / Registre este producto en [www.greenlee.com](http://www.greenlee.com)  
Enregistrez votre produit en ligne, [www.greenlee.com](http://www.greenlee.com)

## Description

The Greenlee DM-810A, DM-820A, DM-830A, and DML-430A Digital Multimeters are hand-held testing devices with the following measurement capabilities: AC and DC voltage, AC and DC current, frequency, resistance, capacitance, and duty cycle of logic level signals. They also check diodes and verify continuity. All meters feature true RMS AC measurements, a relative zero mode, data hold mode, and an intelligent automatic power off. An optional optically isolated computer interface with software facilitates the recording of readings from the meter to a computer.

Other specialized capabilities and functions common to all meters include:

- Dual display shows two measurements, such as AC voltage and frequency, at the same time.
- Backlighted LCD for reading in dim conditions.
- Beep-Jack™ audible warning alerts the user with a beep and an error message on the LCD if the test lead is plugged into the **mA/μA** or **A** input terminal while the selector switch is not in the **mA/μA** or **A** position.
- Bar graph display, which responds more quickly than the numeric display — useful for detecting faulty contacts, potentiometer clicks, and signal spikes.

The DM-820A, DM-830A, and DML-430A multimeters have the following additional capabilities: temperature (K-type thermocouples only); conductance; a crest function, which captures voltage or current signal peaks; and a recording function, which stores the maximum, minimum, and difference (maximum-minimum) input readings. The DM-820A and DM-830A record function can also calculate the average reading. These two models also have non-contact and single-probe voltage detection.

The DM-830A and the DML-430A multimeters have an AutoCheck™ function for automatic selection of AC voltage, DC voltage, and resistance with low input impedance to mask “ghost” voltages. Both multimeters feature a T1-T2 function, which can measure and display two temperatures and calculate the difference. They also feature AC + DC true RMS measurement capability. The DM-830A has a dBm function with selectable reference impedances. The DML-430A has the capability to store data.

## Safety

Safety is essential in the use and maintenance of Greenlee tools and equipment. This instruction manual and any markings on the tool provide information for avoiding hazards and unsafe practices related to the use of this tool. Observe all of the safety information provided.

## Purpose of This Manual

This instruction manual is intended to familiarize all personnel with the safe operation and maintenance procedures for the Greenlee DM-810A, DM-820A, DM-830A, and DML-430A Digital Multimeters.

Keep this manual available to all personnel. Replacement manuals are available upon request at no charge at [www.greenlee.com](http://www.greenlee.com).



**Do not discard this product or throw away!**

For recycling information, go to [www.greenlee.com](http://www.greenlee.com).

## Important Safety Information



### SAFETY ALERT SYMBOL

This symbol is used to call your attention to hazards or unsafe practices which could result in an injury or property damage. The signal word, defined below, indicates the severity of the hazard. The message after the signal word provides information for preventing or avoiding the hazard.

#### **DANGER**

Immediate hazards which, if not avoided, **WILL** result in severe injury or death.

#### **WARNING**

Hazards which, if not avoided, **COULD** result in severe injury or death.

#### **CAUTION**

Hazards or unsafe practices which, if not avoided, **MAY** result in injury or property damage.



#### **WARNING**

**Read and understand** this material before operating or servicing this equipment. Failure to understand how to safely operate this tool could result in an accident causing serious injury or death.



#### **WARNING**

Electric shock hazard:  
Contact with live circuits could result in severe injury or death.

All specifications are nominal and may change as design improvements occur. Greenlee Textron Inc. shall not be liable for damages resulting from misapplication or misuse of its products.

© Registered: The color green for electrical test instruments is a registered trademark of Greenlee Textron Inc.

AutoCheck and Beep-Jack are trademarks of BTC.

Microsoft and Windows are registered trademarks of Microsoft Corporation.

**KEEP THIS MANUAL**

## Important Safety Information

### **WARNING**

Electric shock and fire hazard:

- Do not expose this unit to rain or moisture.
- Do not use the unit if it is wet or damaged.
- Use test leads or accessories that are appropriate for the application. Refer to the category and voltage rating of the test lead or accessory.
- Inspect the test leads or accessory before use. They must be clean and dry, and the insulation must be in good condition.
- Use this unit for the manufacturer's intended purpose only, as described in this manual. Any other use can impair the protection provided by the unit.

Failure to observe these warnings could result in severe injury or death.

### **WARNING**

Electric shock hazard:

- Do not apply more than the rated voltage between any two input terminals, or between any input terminal and earth ground.
- Do not contact the test lead tips or any uninsulated portion of the accessory.

Failure to observe these warnings could result in severe injury or death.

### **WARNING**

Electric shock hazard:

- Do not operate with the case open.
- Before opening the case, remove the test leads from the circuit and shut off the unit.

Failure to observe these warnings could result in severe injury or death.

### **WARNING**

Electric shock hazard:

The fuses are an integral part of the overvoltage protection. When fuse replacement is necessary, refer to "Specifications" for the correct type, size, and capacity. Using any other type of fuse will void the overvoltage protection rating of the unit.

Failure to observe this warning could result in severe injury or death.

## Important Safety Information

### WARNING

Electric shock hazard:

- Unless measuring voltage, current, or frequency, shut off and lock out power. Make sure that all capacitors are discharged. Voltage must not be present.
- Set the selector and connect the test leads so that they correspond to the intended measurement. Incorrect settings or connections can result in a blown fuse.
- Using this unit near equipment that generates electromagnetic interference can result in unstable or inaccurate readings.

Failure to observe these warnings could result in severe injury or death.

### CAUTION

Electric shock hazard:

Do not change the measurement function while the test leads are connected to a component or circuit.

Failure to observe this precaution may result in injury and can damage the unit.

### CAUTION

Electric shock hazard:

Do not use the tester to measure voltages in circuits that could be damaged or activated by the AutoCheck™ mode's low input impedance (approximately 3.0 k $\Omega$  and 150 pF).

Failure to observe this precaution may result in injury and can damage the unit.

### CAUTION

Electric shock hazard:

- Do not attempt to repair this unit. It contains no user-serviceable parts.
- Do not expose the unit to extremes in temperature or high humidity. Refer to "Specifications."

Failure to observe these precautions may result in injury and can damage the unit.

## Identification

- |  |  |
|--|--|
| 1. Display                                       | LCD and bar graph  |
| 2. Feature Buttons                               | Refer to explanations under “Using the Features”   |
| 3. Selector                                      | Selects a function or turns power OFF  |
| 4. <b>A</b>                                      | Positive input terminal for high current measurements                                      |
| 5. <b>mA <math>\mu</math>A</b>                   | Positive input terminal for low current measurements                                       |
| 6. <b>COM</b>                                    | Negative, common, or ground input terminal for all measurements                            |
| 7. <b><math>\Omega</math> V <math>\pm</math></b> | Positive input terminal for all measurements except current and temperature measurement T2 |

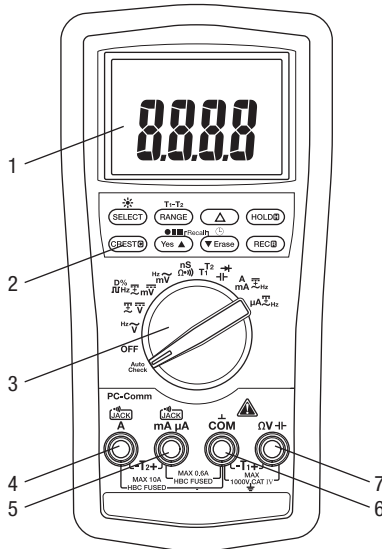

## Display Icons

### Primary Display

- 8. **■** Bar graph element
- 9. **-** Polarity indicator for bar graph
- 10. **I** Bar graph scale
- 11. **LoZ** AutoCheck™ mode; low input impedance is active.
- 12. **Δ** Relative zero function is enabled.
- 13. **-** Polarity indicator
- 14. **8.8.8.8** Numeric display
- 15. **T1-T2** T1, T2, or T1-T2 function is enabled.
- 16. **~** AC measurement is selected.
- 17. **≡** DC measurement is selected.
- 18. **AVG** AVG function is enabled; recorded value is displayed.
- 19. **MAX-MIN** Max-Min function is enabled; recorded value is displayed.
- 20. **R** Record function is enabled.
- 21. **C** Crest capture function is enabled.
- 22. **H** Hold function is selected.
- 23. **AUTO** Automatic ranging is enabled.
- 24. **•))** Continuity
- 25. **+** Low battery
- 26. **▶** Overload symbol (bar graph display)
- 27. **10** Bar graph maximum range indicator
- 28. **dBm** Decibel
- 29. **m** Milli (10<sup>-3</sup>)
- 30. **V** Volt
- 31. **A** Ampere
- 32. **n** Nano (10<sup>-9</sup>)

- 33. **μ** Micro (10<sup>-6</sup>)
- 34. **S** Siemen
- 35. **F** Farad
- 36. **D%** Duty cycle function is enabled.
- 37. **k** Kilo (10<sup>3</sup>)
- 38. **Hz** Hertz (frequency in cycles per second)
- 39. **M** Mega (10<sup>6</sup>)
- 40. **Ω** Ohm

### Secondary Display

- 41. **M** Mega (10<sup>6</sup>)
- 42. **k** Kilo (10<sup>3</sup>)
- 43. **Ω** Ohm
- 44. **Hz** Hertz (frequency in cycles per second)
- 45. **m** Milli (10<sup>-3</sup>)
- 46. **μ** Micro (10<sup>-6</sup>)
- 47. **A** Ampere
- 48. **V** Volt
- 49. **D%** Duty cycle function is enabled.
- 50. **n** Nano (10<sup>-9</sup>)
- 51. **S** Siemen
- 52. **F** Farad
- 53. **8.8.8.8** Numeric display
- 54. **≡** DC measurement is selected.
- 55. **~** AC measurement is selected.
- 56. **-** Polarity indicator
- 57. **T1** T1 function is enabled.
- 58. **T2** T2 function is enabled.

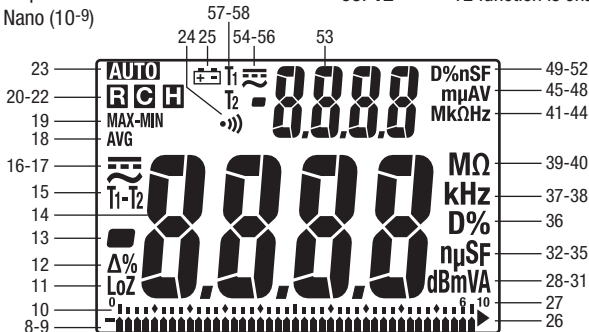



## Using the Features

### All Models

- **Dual Digital Display:** These meters can display two measurements, such as AC voltage and frequency, at the same time. Display combinations are shown using large symbols to indicate the measurement on the primary display and small, raised symbols to indicate the measurement on the secondary display. For example, “VAC<sup>Hz</sup>” means the primary display contains the AC voltage measurement, and the secondary display contains the frequency measurement.
- **SELECT:** Press momentarily to toggle between functions, or to toggle between AC and DC when measuring current and millivolts.

- **RANGE:** Press once to enter the manual ranging mode. The **AUTO** icon will disappear from the display. Press repeatedly to step through the ranges. Press and hold to return to the automatic ranging mode.

*Note: When using MAX-MIN, HOLD, or  $\Delta$  mode, pressing RANGE will cause the meter to exit that mode.*

- **$\Delta$ :** Finds the difference between two measurements. While taking a measurement, press  $\Delta$  to set the display to zero. The  $\Delta$  icon will appear on the display. Take the second measurement. The value on the display will be the difference between the two measurements. Press again to exit this mode.

- **HOLD **: Press momentarily to hold the present value on the display. Press again to exit this mode.



*This feature does not affect the bar graph.*

- ****: Press and hold until backlight illuminates. Press and hold again to turn off. The backlight automatically turns off after approximately 30 seconds to extend battery life.

- **Automatic Power Off:** To extend battery life, the meter will shut itself off after approximately 30 minutes of inactivity. To restore power, press either the **SELECT**, **RANGE**,  **$\Delta$** , or **HOLD** button momentarily, or turn the selector to **OFF** and then back on. To disable this feature, press **SELECT** while turning the meter on.

- **Disabling the Beeper:** Hold down the **RANGE** button while turning the meter on to temporarily disable the beeper feature. Turn the selector to **OFF** and then back on to enable the beeper.

### DM-820A, DM-830A, and DML-430A Only

- **CREST **: Press momentarily to activate the crest recording mode. The input value is measured every 1 ms in this mode.  and “MAX” will appear on the display. The LCD will display the maximum crest value. Press repeatedly to select the desired display: maximum, minimum, or maximum–minimum crest value. Press and hold to exit this mode.

*The automatic power off feature is disabled when using this function.*

*Note: When using the CREST function, pressing RANGE will cause the meter to exit this mode.*

- **REC **: Press momentarily to activate the MAX/MIN/AVG\* recording mode. The input value is measured every 50 ms in this mode. “MAX MIN” and “AVG”\*\* will appear on the display. The LCD will display the actual input value. The meter will beep whenever the maximum or minimum is updated. Press repeatedly to select the desired display: maximum, minimum, maximum–minimum, average\*, or actual input. Press and hold to exit this mode.

\*Average function is not available on DML-430A.

*The automatic power off feature is disabled when using this function.*

## Using the Features (cont'd)

*Note: When using the REC function, pressing RANGE will cause the meter to exit this mode.*

### DM-820A and DM-830A Only

- **EF:** Set the meter to any current or voltage function. Press and hold until the meter displays “EF” to detect the electric field that surrounds current-carrying conductors. Signal strength is displayed as a series of dashes on the display.
  - Use the tester’s built-in antenna (located along the top, near the LCD) for tracing live circuits or locating a break in a wire.
  - For more precision, such as distinguishing between current-carrying and ground wires, connect a test lead to the + input terminal and use it as a probe for direct contact verification of a signal.

### DM-830A and DML-430A Only

- **Low Impedance AutoCheck™ Mode:** In this mode, the meter automatically selects the proper measurement based on the input.
  - If there is no input, “Auto” appears on the display.
  - If the voltage is above approximately 1.5 volt DC or 3 volt AC up to the rated 1000 volts, voltage is displayed.
  - If both AC and DC voltages are present, the larger voltage is displayed.
  - If no voltage is present and there is resistance less than 60 M $\Omega$ , resistance is displayed. If the measured resistance is below the continuity threshold (between 20  $\Omega$  and 300  $\Omega$ ), then the continuity tone will sound.

This mode features low input impedance to mask stray or “ghost” voltage pickup. The input impedance is approximately 3 k $\Omega$  at low voltage, increasing to approximately 460 k $\Omega$  at 1000 V.

The symbol “LoZ” indicates that the meter is in a low impedance mode. Do not use the AutoCheck™ mode on circuits that could be damaged or activated by such low input impedance. Instead use the selector to select the high impedance AC or DC volt modes to minimize loading for such circuits.

**Range-Lock and Function Feature:** While in the AutoCheck™ mode, press the **SELECT** button momentarily to lock the displayed function. Press the **RANGE** button momentarily to lock the displayed measurement range.

**Energized Circuit Alert:** If the resistance mode is locked in the AutoCheck™ mode and the leads are placed across an energized circuit, the meter will emit an audible warning tone.

- **T1-T2:** Press momentarily to select the desired temperature display: T1, T2, T1<sup>T2</sup>, or T1-T2<sup>T2</sup>.
- **dBm- $\Omega$  (DM-830A only):** In dBm mode, press momentarily to select the reference impedance. Refer to the “Specifications” section for the available values.
- **Blue Feature Buttons (DML-430A only):** Refer to the “Data Storage Function” section for an explanation of these features.

## AC Measurement



AC measurements are usually displayed as RMS (root mean square) values. The RMS value is equal to the value of a DC waveform, which would deliver the same power if it replaced the time-varying waveform. Two AC measurement methods are average-responding RMS calibrated and true RMS-reading.

The average-responding RMS calibrated method takes the average value of the input signal after full wave rectification, multiplies it by 1.11, and displays the result. This method is accurate if the input signal is a pure sine wave.

The true RMS-reading method uses internal circuitry to read the true RMS value. This method is accurate, within the specified crest factor limitations, whether the input signal is a pure sine wave, square wave, triangle wave, half wave, or signal with harmonics. The ability to read true RMS provides much more measurement versatility. The Greenlee DM-810A, DM-820A, DM-830A, and DML-430A are true RMS meters.

The Waveforms and Crest Factors table shows some typical AC signals and their RMS values.

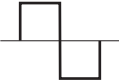
### Waveforms and Crest Factors

Waveform				
RMS Value	100	100	100	100
Average Value	90	100	87	64
Crest Factor* ( $\xi$ )	1.414	1	1.73	2

\* The crest factor is the ratio of the peak value to the RMS value; it is represented by the Greek letter  $\xi$ .

## AC + DC True RMS

AC + DC true RMS calculates both of the AC and DC components given by the expression

$$\sqrt{(AC\ rms)^2 + DC^2}$$

when making measurements and responds accurately to the total effective RMS value regardless of the waveform. Distorted waveforms with the presence of DC components and harmonics may cause:

- Transformers, generators, and motors to overheat
- Circuit breakers to trip prematurely
- Fuses to blow
- Neutrals to overheat due to the triplen harmonics present on the neutral
- Bus bars and electrical panels to vibrate

The DM-830A and DML-430A are AC + DC true RMS meters.

## Data Storage Function (DML-430A only)

The DML-430A has data storage and retrieval capability. It can store up to 87,000 measurements in single display mode or 43,000 measurements in dual display mode. The data can later be reviewed on the multimeter's display, or downloaded the data to a computer using the optional interface DMSC-9U.





When in the recording mode, the meter takes a measurement, assigns that measurement to the next available memory location, and repeats the process. This continues until the memory is full or until the user manually stops the recording process.

The time interval between measurements (sampling rate) is selected by the user. A shorter time interval will provide information about short-term fluctuations, whereas a longer time interval will provide information about general trends. The factory setting is the shortest time interval.

The time intervals are as follows: 0.05 seconds (0.1s for single T1/T2, Diode, and Ohms/nS; 0.5s for Hz and Duty Cycle; 2s for Capacitance and dual screen T1/T2 and T1-T2), 0.1s, 0.5s, 1s, 2s, 3s, 4s, 5s, 10s, 15s, 30s, 60s, 120s (two minutes), 180s (three minutes), 300s (5 minutes), and 600s (10 minutes). The minimum total measurement time for the DML-430A is 72 minutes and 30 seconds; the maximum is nearly 20 months.

When the sampling rate is 30s or greater, the meter will go to standby mode between measurements to extend battery life. When the meter is in the standby mode, press **SELECT** momentarily to view the display.

### To set the measurement interval:

Press  for 1 second or more and the meter will display the current measurement interval in seconds. Press  or  to change the measurement interval. Press  for 1 second or more to save the new setting.

### To start recording data:

Press the  button for 1 second or more to start the data logging mode.

"LEFT" displays followed by the number of remaining memory in the logger. The number in the secondary display is the most significant digit, and the numbers in the primary display are the least significant digits of the remaining memory points.

Momentarily press the **Yes** button to confirm a new logging session without erasing the formerly logged ones (up to 999 sessions can be stored without overwriting previous sessions). Press the **Erase** button momentarily to erase *all* of the sessions and start from the first session with full memory.

"Strt" will display on the primary screen and then the logger will start recording. When a sampling speed of 30s or longer is selected, the meter will enter a power down mode after 4.5 minutes. Press the **SELECT** button momentarily to resume real time display.

*Options—during recording:*

- Press the **SELECT** button momentarily to toggle the display mode between measuring data and logged data item number. The secondary display contains the most significant number and the primary display contains the least significant numbers of the logged data item number.
- Press the  button momentarily to pause/resume logging.

## Data Storage Function (DML-430A only) (cont'd)

### To stop recording data:

While the meter is logging data, press the **●■■■** button for more than 1 second.

### To review stored data:

Press **▲** and **▼** momentarily to enter Recall mode. The last session number displays for 0.5 seconds and then displays the last logged data item as well the **B** and **C** annunciators.

*Options—while reviewing data:*

- Press **▲** or **▼** momentarily to step through the data.
- Press **SELECT** to toggle between the data and the logged data item number.
- Press *and hold* **▲** or **▼** to quickly scan through the data. Tone indicates that the first or last measurement is displayed.
- Press **▲** and **▼** momentarily to select another session page.
- Press **▲** and **▼** for 1 second for fast scrolling, and hold either **▲** or **▼** to quickly scroll through the pages. Tone indicates that the first or last session page is displayed.
- Press **▲** or **▼** momentarily while holding down the **HOLD** button to scan through the turning points (the alternating high and low points) or the data set. “MAX” or “MIN” will flash to indicate a high or low point.

To exit Recall mode, rotate the selector to a different setting or turn the meter off.

## Using the Optional Software

These meters are compatible with Greenlee DMSC-9U, an optically isolated computer interface cable and software. It allows measurements to be logged to a personal computer using the Microsoft® Windows® operating system. It also allows retrieval of data stored in the internal memory of DML-430A.

### Installing the Software

1. Insert the CD into the computer's CDROM drive.
2. The installation program should launch automatically. If it does not, double click on the CD icon in "My Computer."
3. The installation program menu will appear. Click on "Software Installation."
4. Type your meter's catalog number (for example, "DM-820A") in the dialog box.
5. Complete the remaining dialog boxes according to user preferences.

### Connecting the Optical USB Interface Cable

1. Align the key of the connector with the key slot on the meter.
2. Twist the connector clockwise until it locks into place.
3. Connect the cable to a USB port of the PC.

Key slot on back of meter

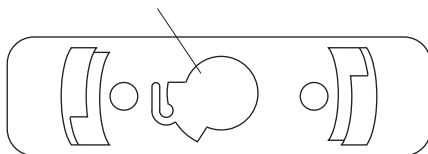

## Operation





	<b>⚠ WARNING</b>
	<p>Electric shock hazard: Contact with live circuits could result in severe injury or death.</p>

1. Refer to the Settings Table. Set the selector to the proper setting, press **SELECT** (when instructed to do so), and connect the test leads to the meter.
2. Refer to “Typical Measurements” for specific measurement instructions.
3. Test the unit on a known functioning circuit or component.
  - If the unit does not function as expected on a known functioning circuit, replace the battery and/or fuses.
  - If the unit still does not function as expected, call Greenlee for technical assistance at 800-435-0786.
4. Take the reading from the circuit or component to be tested.

### Settings Table

The meter stores the last used function of each selector position in its nonvolatile memory. If this is not the correct function when you turn the selector, press **SELECT** until the desired icon appears.























The dual display options are shown along with the icons. In the table, “~VHz” indicates that “~” and “V” appear in the primary display, and “Hz” appears in the secondary display. This combination shows the AC voltage measurement in the primary display and frequency in the secondary display.

To measure this characteristic ...	Set the selector to this symbol ...	Press SELECT until these icons appear on the display ...	Connect the red lead to ...	Connect the black lead to ...
<b>All Models</b>				
Voltage—AC (1000 V max)		~VHz or Hz~V	ΩV — —	COM
Voltage—DC (1000 V max)		=== V or === V~V	ΩV — —	COM
Voltage—DC (600 mV max)		=== mV or === mV~mV	ΩV — —	COM
Voltage—AC (600 mV max)		~mVHz or Hz~mV	ΩV — —	COM

*This table continues on the next page.*

## Operation (cont'd)

### Settings Table (cont'd)









To measure this characteristic ...	Set the selector to this symbol ...	Press SELECT until these icons appear on the display ...	Connect the red lead to ...	Connect the black lead to ...
<b>All Models (cont'd)</b>				
*Frequency—Logic Level	 Hz	Hz	$\Omega$ 	COM
Frequency—Line Level Voltage or Current	Set for voltage or current according to this table.	Any display option that includes Hz	—	—
% Duty Cycle	<b>D%</b>	D%	$\Omega$ 	COM
Resistance	$\Omega$	$\Omega$	$\Omega$ 	COM
Continuity			$\Omega$ 	COM
**Capacitance		F	$\Omega$ 	COM
Diode		V and diod	$\Omega$ 	COM
Current—AC/DC (10 A max)	<b>A</b>	 A,  A~A or  Hz	A	COM
Current—AC/DC (600 mA max)	<b>mA</b>	 mA,  mA~mA or  mHz	m $\mu$ A	COM
Current—AC/DC (6000 $\mu$ A max)	<b><math>\mu</math>A</b>	 $\mu$ A,  $\mu$ A~ $\mu$ A or  $\mu$ Hz	m $\mu$ A	COM
<b>DM-820A, DM-830A, and DML-430A Only</b>				
Conductance	<b>nS</b>	nS	$\Omega$ 	COM
Temperature (DM-820A)	<b>Temp</b>	$^{\circ}$ C or $^{\circ}$ F	See Note 1	—
Dual Temperature (DM-830A and DML-430A)	<b>T1T2</b>	$^{\circ}$ C or $^{\circ}$ F (press <b>RANGE</b> for display options T1, T2, T1T2 or T1-T2T2)	See Notes 1 and 2	—
<b>DM-820A and DM-830A Only</b>				
$\uparrow$ EF (electric field detection)	Any voltage or current function; press and hold <b>EF</b> for 1 s or more	EF	$\Omega$  (contact mode only)	—

This table continues on the next page.



## Operation (cont'd)

### Settings Table (cont'd)

To measure this characteristic ...	Set the selector to this symbol ...	Press SELECT until these icons appear on the display ...	Connect the red lead to ...	Connect the black lead to ...
<b>DM-830A and DML-430A Only</b>				
Voltage—AC + DC True RMS (1000 V max)		 V-V	$\Omega$ $\text{---}$	COM
Voltage—AC + DC True RMS (600 mV max)		 mV~mV	$\Omega$ $\text{---}$	COM
Current—AC + DC True RMS (10 A max)	<b>A</b>	 A~A	A	COM
Current—AC + DC True RMS (600 mA max)	<b>mA</b>	 mA~mA	m $\mu$ A	COM
Current—AC + DC True RMS (6000 $\mu$ A max)	<b><math>\mu</math>A</b>	 $\mu$ A~ $\mu$ A	m $\mu$ A	COM
†Auto select AC volts, DC volts, resistance, and continuity (low impedance measurement)	<b>AutoCheck</b>	LoZ and <b>AUTO</b> (LoZ with  ,  V or $\Omega$ when using Feature Lock)	$\Omega$ $\text{---}$	COM
<b>DM-830A Only</b>				
dBm (0 dB = 1 mW in reference impedance)	<b>dBm</b>	Reference impedance and dBm for 1 s, then dBm <sup>Hz</sup> (press <b>RANGE</b> to change reference impedance)	$\Omega$ $\text{---}$	COM

\* Logic level frequency has a fixed sensitivity and is for digital signals. Refer to “Accuracy”.

\*\* Discharge capacitor before measurement. Refer to “Typical Measurements” regarding polarized capacitors.

† Refer to “Using the Features” for a detailed description of this mode.

Note 1: T1+ connects to  $\Omega$   $\text{---}$  and T1– connects to COM.

Note 2: T2+ connects to m $\mu$ A and T2– connects to A.

## Typical Measurements

### Voltage Measurement

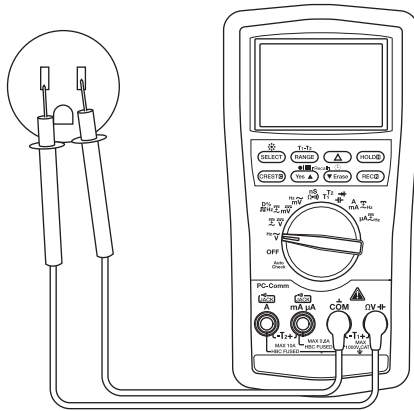

### Current Measurement

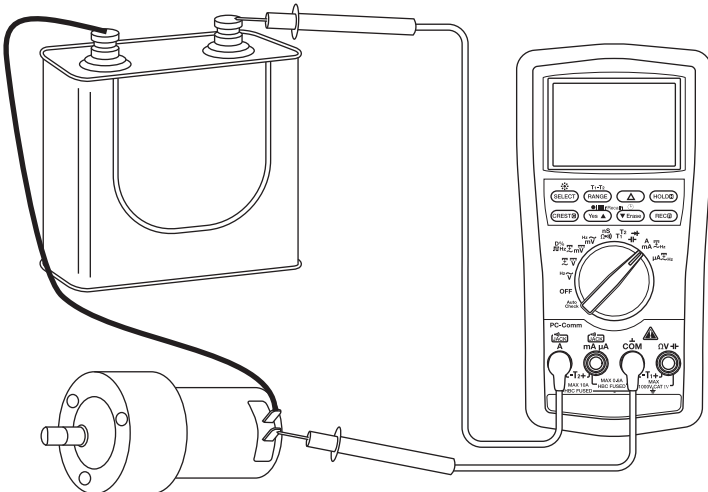

## Typical Measurements

### Resistance Measurement

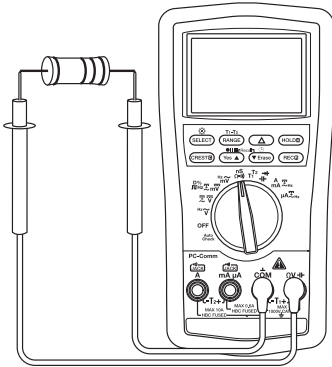

### Continuity Check

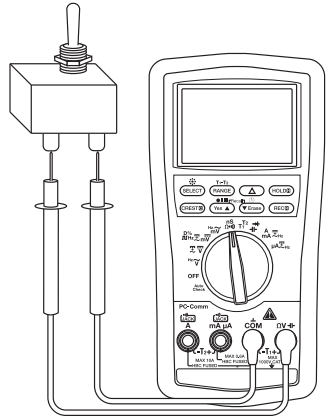

### Capacitance Measurement

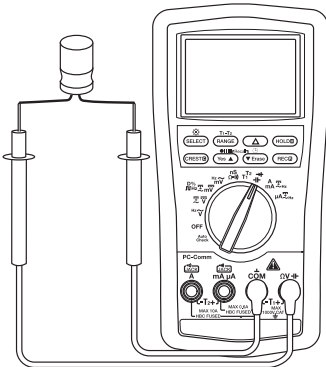

### Diode Measurement

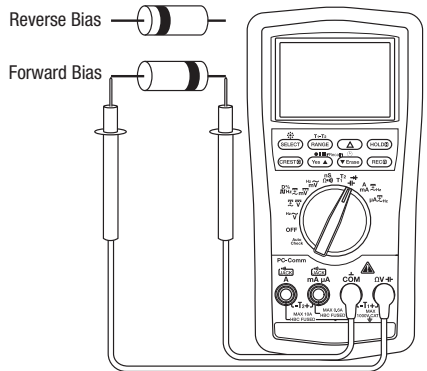

## Typical Measurements

### Temperature

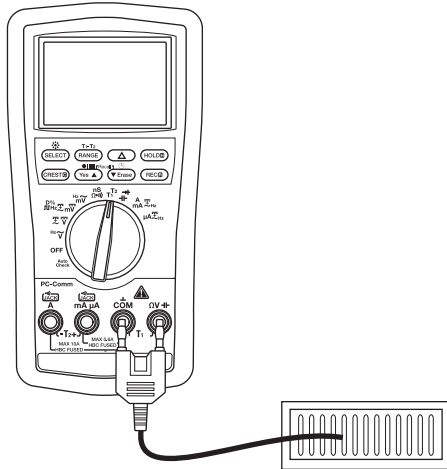

### Electric Field Detection (EF)

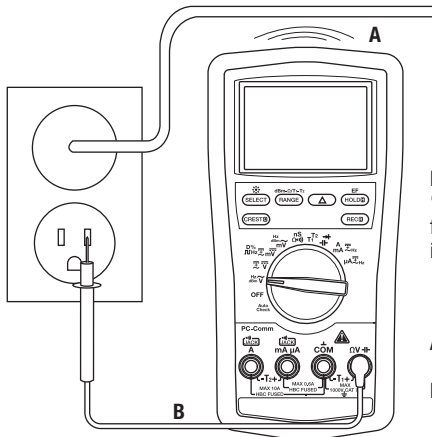

Refer to  
"Using the Features"  
for complete  
instructions.

A-Non-contact  
OR  
B-Contact

## Accuracy

Refer to the “Specifications” section for operating conditions and temperature coefficient.

Accuracy is specified as follows:  $\pm$  (a percentage of the reading + a fixed amount) at  $23\text{ }^{\circ}\text{C} \pm 5\text{ }^{\circ}\text{C}$  ( $73.4\text{ }^{\circ}\text{F} \pm 9\text{ }^{\circ}\text{F}$ ), 0% to 75% relative humidity.

True RMS Readings: Voltage and current accuracies are specified from 10% to 100% of the range unless otherwise specified. Frequency must be within the specified bandwidth for non-sinusoidal waveforms. Crest factors are as follows:

- Crest factor < 3:1 at full scale
- Crest factor < 6:1 at half scale

## All Models

### AC Voltage (AC + DC Voltage on DM-830A and DML-430A Only)

Range	Accuracy at 50 to 60 Hz	Accuracy at 40 to 500 Hz	Accuracy at 500 Hz to 1 kHz	Accuracy at 1 to 3 kHz	Accuracy at 3 to 20 kHz
60.00 mV	$\pm (0.5\% + 0.03\text{ mV})$	$\pm (0.8\% + 0.04\text{ mV})$	$\pm (2.0\% + 0.03\text{ mV})$	$\pm (2\% + 0.03\text{ mV})$	$\pm (2\% + 0.03\text{ mV})^{(1)}$
600.0 mV	$\pm (0.5\% + 0.3\text{ mV})$	$\pm (0.8\% + 0.4\text{ mV})$	$\pm (2.0\% + 0.3\text{ mV})$	$\pm (2\% + 0.3\text{ mV})$	$\pm (2\% + 0.3\text{ mV})^{(1)}$
9.999 V	$\pm (0.5\% + 0.003\text{ V})$	$\pm (1.0\% + 0.004\text{ V})$	$\pm (1.0\% + 0.004\text{ V})$	$\pm (3\% + 0.004\text{ V})$	3 dB
99.99 V	$\pm (\pm 0.5\% + 0.03\text{ V})$	$\pm (1.0\% + 0.04\text{ V})$	$\pm (1.0\% + 0.04\text{ V})$	$\pm (3\% + 0.04\text{ V})$	3 dB
999.9 V	$\pm (0.5\% + 0.3\text{ V})$	$\pm (2.0\% + 0.4\text{ V})$	$\pm (2.0\% + 0.4\text{ V})$	$\pm (3\% + 0.4\text{ V})$	Unspecified

<sup>(1)</sup> Specified from 30% to 100% of range

Input Impedance: 10 M $\Omega$ , 50 pF nominal (80 pF nominal for 600 mV range)

## DC Voltage

Range	Accuracy
60.00 mV	$\pm (0.12\% + 0.02\text{ mV})$
600.0 mV	$\pm (0.06\% + 0.2\text{ mV})$
9.999 V	$\pm (0.08\% + 0.002\text{ V})$
99.99 V	$\pm (0.08\% + 0.02\text{ V})$
999.9 V	$\pm (0.08\% + 0.2\text{ V})$

Input Impedance: 10 M $\Omega$ , 50 pF nominal (80 pF nominal for 600 mV range)

## Accuracy (cont'd)

### Resistance and Conductance (Conductance on DM-820A, DM-830A, and DML-430A Only)

Range	Accuracy	Typical Open Circuit Voltage
600.0 $\Omega$	$\pm (0.1\% + 0.3 \Omega)$	1.2 VDC
6.000 k $\Omega$	$\pm (0.1\% + 0.003 \text{ k}\Omega)$	
60.00 k $\Omega$	$\pm (0.1\% + 0.03 \text{ k}\Omega)$	
600.0 k $\Omega$	$\pm (0.1\% + 0.3 \text{ k}\Omega)$	
6.000 M $\Omega$	$\pm (0.4\% + 0.003 \text{ M}\Omega)$	
60.00 M $\Omega$	$\pm (1.5\% + 0.05 \text{ M}\Omega)$	
99.99 nS	$\pm (0.8\% + 0.1 \text{ nS})$	1.2 VDC

### Continuity

Tone Threshold: Between 20  $\Omega$  and 300  $\Omega$

Response Time: < 100  $\mu\text{s}$

### Capacitance

Range	Accuracy <sup>(1)</sup>
60.00 nF	$\pm (0.8\% + 0.03 \text{ nF})$
600.0 nF	$\pm (0.8\% + 0.3 \text{ nF})$
6.000 $\mu\text{F}$	$\pm (1.0\% + 0.003 \mu\text{F})$
60.00 $\mu\text{F}$	$\pm (2.0\% + 0.03 \mu\text{F})$
600.0 $\mu\text{F}$ <sup>(2)</sup>	$\pm (3.5\% + 0.5 \mu\text{F})$
6.000 mF <sup>(2)</sup>	$\pm (5.0\% + 0.005 \text{ mF})$
25.00 mF <sup>(2)</sup>	$\pm (6.5\% + 0.05 \text{ mF})$

<sup>(1)</sup> Accuracies with film capacitor or better

<sup>(2)</sup> In manual ranging mode, measurements are not specified below 50.0  $\mu\text{F}$ , 0.54 mF, and 5.4 mF for 600.0  $\mu\text{F}$ , 6.000 mF and 25.00 mF ranges, respectively

### Diode Test

Measuring Range: 2.000 V

Test Current (typical): 0.4 mA

Open Circuit Voltage: < 3.5 VDC

Accuracy: 1.0% + 0.001 V

## Accuracy (cont'd)

### AC Current (AC + DC Current on DM-830A and DML-430A Only)

Range	Accuracy at 50 to 60 Hz	Accuracy at 40 to 1 kHz	Burden Voltage (typical) (all frequency ranges)
600.0 $\mu$ A	$\pm (0.6\% + 0.3 \mu\text{A})$	$\pm (0.8\% + 0.4 \mu\text{A})$	0.08 mV/ $\mu$ A
6000 $\mu$ A	$\pm (0.6\% + 3 \mu\text{A})$	$\pm (0.8\% + 4 \mu\text{A})$	
60.00 mA	$\pm (0.6\% + 0.03 \text{ mA})$	$\pm (0.8\% + 0.04 \text{ mA})$	2.1 mV/mA
600.0 mA	$\pm (1.0\% + 0.3 \text{ mA})$	$\pm (1.0\% + 0.4 \text{ mA})$	
6.000 A	$\pm (0.8\% + 0.006 \text{ A})$	$\pm (0.8\% + 0.006 \text{ A})$	0.02 V/A
10.00 A	$\pm (0.8\% + 0.06 \text{ A})$	$\pm (0.8\% + 0.06 \text{ A})$	

10 A continuous, 20 A for 30 sec. maximum with 5 minute cool down.

### DC Current

Range	Accuracy at 50 to 60 Hz	Burden Voltage (typical) (all frequency ranges)
600.0 $\mu$ A	$\pm (0.2\% + 0.4 \mu\text{A})$	0.08 mV/ $\mu$ A
6000 $\mu$ A	$\pm (0.2\% + 4 \mu\text{A})$	
60.00 mA	$\pm (0.2\% + 0.04 \text{ mA})$	2.1 mV/mA
600.0 mA	$\pm (0.2\% + 0.4 \text{ mA})$	
6.000 A	$\pm (0.2\% + 0.004 \text{ A})$	0.02 V/A
10.00 A	$\pm (0.2\% + 0.04 \text{ A})$	

10 A continuous, 15 A for 30 sec. maximum (20 A for DML-430A) with 5 minute cool down.

### Line Level Frequency

Function	Sensitivity (Sine RMS)	Range
60.00 mV	40 mV	15.00 Hz to 50.00 kHz
600.0 mV	60 mV	15.00 Hz to 50.00 kHz
9.999 V	2.5 V	15.00 Hz to 10.00 kHz
99.99 V	25 V	15.00 Hz to 10.00 kHz
999.9 V	100 V	15.00 Hz to 10.00 kHz
600.0 $\mu$ A	45 $\mu$ A	15.00 Hz to 3.000 kHz
6000 $\mu$ A	600 $\mu$ A	15.00 Hz to 3.000 kHz
60.00 mA	40 mA	15.00 Hz to 3.000 kHz
600.0 mA	60 mA	15.00 Hz to 3.000 kHz
6.000 A	4 A	15.00 Hz to 3.000 kHz
10.00 A	6 A	15.00 Hz to 3.000 kHz

## Accuracy (cont'd)

### Accuracy for Frequency Ranges

Display Range	Accuracy
99.99 Hz	$\pm (0.04\% + 0.04 \text{ Hz})$
999.9 Hz	$\pm (0.04\% + 0.4 \text{ Hz})$
9.999 kHz	$\pm (0.04\% + 0.004 \text{ kHz})$

#### Frequency—Logic Level

Range: 5.00 Hz to 1.000 MHz

Accuracy:  $\pm (0.004\% + 4 \text{ digits})$

Sensitivity: 2.5 Vp square wave

#### % Duty Cycle

Range: 0.00% to 100.0 %

Accuracy:  $\pm (3 \text{ digits/kHz} + 2 \text{ digits})$

Input Frequency: 5 Hz to 10 kHz

### DM-820A, DM-830A, and DML-430A Only

#### Temperature (DM-820A) and Dual Temperature (DM-830A and DML-430A)

Range	Accuracy
-50 °C to 1000 °C	$\pm (0.3\% + 2 \text{ °C})$
-58 °F to 1832 °F	$\pm (0.3\% + 5 \text{ °F})$

Type-K thermocouple range and accuracy not included

#### Crest Capture (Voltage and Current) for Crests > 1.0 ms in duration

Accuracy: Specified accuracy + 250 digits

#### Record Mode for changes > 100 ms in duration

Accuracy: Specified accuracy + 10 digits

### DM-820A and DM-830A Only

#### Electric Field Detection

Typical Voltage	Bar Graph Indication <sup>(1)</sup>	Frequency Range
10 V to 36 V	—	50 Hz to 60 Hz
23 V to 83 V	--	
59 V to 165 V	---	
124 V to 330 V	----	
More than 250 V	-----	

<sup>(1)</sup> Bar graph indication and tone are proportional to signal strength

Detection Antenna: Top end of the meter

Probe-Contact EF-Detection: For more precise indication of live wires, use the  $\Omega$   $\dashv$  test probe for direct contact measurements



## Accuracy (cont'd)

### DM-830A and DML-430A Only

#### DC Voltage AutoCheck™ Mode

Range	Accuracy
9.999 V	$\pm (0.5\% + 0.003 \text{ V})$
99.99 V	$\pm (0.5\% + 0.03 \text{ V})$
999.9 V	$\pm (0.5\% + 0.3 \text{ V})$

Input Impedance: Initial 3.0 k $\Omega$  // 165 pF typical at voltages up to 50 V;  
increases with voltage to approximately 500 k $\Omega$  at 1000 V

Auto Check Trigger Level: > +1.5 VDC and < -1.0 VDC typical

#### AC Voltage AutoCheck™ Mode

Range (50/60 Hz)	Accuracy
9.999 V	$\pm (1.0\% + 0.004 \text{ V})$
99.99 V	$\pm (1.0\% + 0.04 \text{ V})$
999.9 V	$\pm (1.0\% + 0.4 \text{ V})$

Input Impedance: Initial 3.0 k $\Omega$  // 150 pF typical at voltages up to 50 V;  
increases with voltage to approximately 460 k $\Omega$  at 1000 V

Auto Check Trigger Level: > 1.0 V (50/60 Hz) typical

#### Resistance AutoCheck™ Mode

Range	Accuracy
600.0 $\Omega$	$\pm (0.5\% + 0.4 \Omega)$
6.000 k $\Omega$	$\pm (0.5\% + 0.004 \text{ k}\Omega)$
60.00 k $\Omega$	$\pm (0.5\% + 0.04 \text{ k}\Omega)$
600.0 k $\Omega$	$\pm (0.5\% + 0.4 \text{ k}\Omega)$
6.000 M $\Omega$	$\pm (0.8\% + 0.003 \text{ M}\Omega)$
60.00 M $\Omega$	$\pm (2.0\% + 0.05 \text{ M}\Omega)$

Open Circuit Voltage: < 1.2 VDC (< 1.0 VDC for 60 M $\Omega$  range)

#### dBm (DM-830A Only)

At 600  $\Omega$ : -11.76 dBm to 54.25 dBm

Accuracy:  $\pm 0.25 \text{ dB} + 2\text{d}$  (at 40 Hz to 20 kHz)

Input Impedance: 10 M $\Omega$ , 50 pF nominal

Selectable reference impedance of 4, 8, 16, 32, 50, 75, 93, 110, 125, 135, 150, 200, 250, 300, 500, 600, 800, 900, 1000, 1200  $\Omega$

## Specifications

### Display:

9999 counts: ACV, DCV, Hz, and nS

6000 counts: mV,  $\mu$ A, mA, A, ohm, and capacitance

Polarity: Automatic

### Sampling Rate:

Numeric Display: 5 per second

41-Segment Bar Graph Display: 60 per second

Temperature Coefficient: Nominal 0.15 x (specified accuracy) per °C

below 18 °C or above 28 °C

Automatic Power Off: After 30 minutes of inactivity.

To disable this feature, press **SELECT** while turning the meter on.

### Noise Rejection\*:

Normal Mode Rejection Ratio > 60 dB at 50 Hz and 60 Hz when measuring DCV

Common Mode Rejection Ratio > 60 dB from 0 Hz to 60 Hz when measuring ACV

Common Mode Rejection Ratio > 120 dB at 0 Hz, 50 Hz and 60 Hz when measuring DCV

### Operating Conditions:

0 °C to 45 °C (32 °F to 113 °F), 0% to 80% relative humidity (non-condensing)

Altitude: 2000 m (6500') maximum

Indoor use only

Pollution Degree: 2

Storage Conditions: -20 °C to 60 °C (-4 °F to 140 °F)

0% to 80% relative humidity (non-condensing)

Remove battery.

Battery: 9-Volt (NEDA 1604, JIS 006P or IEC 6F22)

### Overload Protections:

DM-810A, DM-820A, and DM-830A:

Volts: 1050 V RMS AC/DC, 1450 V peak AC/DC

Millivolts: 600 VDC and VAC RMS

A: 11 A / 1000 V fuse, interrupting rating 20 kA, F fuse, 13/32" x 1-1/2"

$\mu$ A and mA: 0.44 A/1000 V fuse, interrupting rating 10 kA, F fuse, 13/32" x 1-1/2"

Other Functions: 600 VDC and VAC RMS

DML-430A:

Volts: 1050 V RMS AC/DC, 1450 V peak AC/DC

Millivolts: 1050 V RMS AC/DC, 1450 V peak AC/DC

A: 11 A/1000 V fuse, interrupting rating 20 kA, F fuse, 13/32" x 1-1/2"

$\mu$ A and mA: 0.44 A/1000 V fuse, interrupting rating 10 kA, F fuse, 13/32" x 1-3/8"

Other Functions: 1050 V RMS AC/DC, 1450 V peak AC/DC