



Chipsmall Limited consists of a professional team with an average of over 10 year of expertise in the distribution of electronic components. Based in Hongkong, we have already established firm and mutual-benefit business relationships with customers from,Europe,America and south Asia,supplying obsolete and hard-to-find components to meet their specific needs.

With the principle of “Quality Parts,Customers Priority,Honest Operation,and Considerate Service”,our business mainly focus on the distribution of electronic components. Line cards we deal with include Microchip,ALPS,ROHM,Xilinx,Pulse,ON,Everlight and Freescale. Main products comprise IC,Modules,Potentiometer,IC Socket,Relay,Connector.Our parts cover such applications as commercial,industrial, and automotives areas.

We are looking forward to setting up business relationship with you and hope to provide you with the best service and solution. Let us make a better world for our industry!



Contact us

Tel: +86-755-8981 8866 Fax: +86-755-8427 6832

Email & Skype: info@chipsmall.com Web: www.chipsmall.com

Address: A1208, Overseas Decoration Building, #122 Zhenhua RD., Futian, Shenzhen, China



Timers Multifunction Types DMC01, PMC01

CARLO GAVAZZI



- Time range 0.1 s to 100 h
- 7 knob selectable functions
 - Op - Delay on operate, manual start
 - Oa - Delay on operate, automatic and manual start
 - In - Interval, manual start
 - Ia - Interval, automatic and manual start
 - Nr - Interval with no time reset, manual start
 - Na - Interval with no time reset, automatic and manual start
 - Dr - Delay on release
- Knob selection of time range
- Knob adjustable time setting
- External adjustable time setting available
- Repeatability: $\leq 0.2\%$
- DC supply for PNP/NPN and Namur sensors
- Output: 8 A SPDT or 2 x 8 A SPDT relay
- For mounting on DIN-rail in accordance with DIN/EN 50 022 or Plug-in
- 22.5 mm or 45 mm Euronorm or 36 mm Plug-in module housing
- LED indication for relay status and power supply ON

Product Description

Multi-voltage timer with 7 knob selectable functions and 7 knob selectable time ranges within 0.1s and 100h. Remote time setting available.

15 VDC, 10 mA (1 relay) or 24 VDC, 15 mA (2 relays) supply for PNP/NPN sensors and 8.2 VDC supply for Namur sensor. For mounting on DIN-rail (DMC01) or Plug-in (PMC01).

Ordering key

DMC 01 C B23

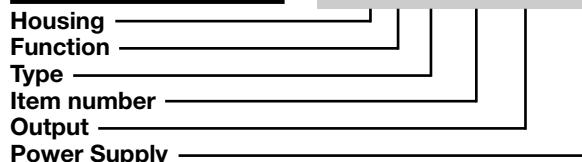

Type Selection

Mounting	Output	Housing	Supply: 24 VDC	Supply: 24 or 48 VAC	Supply: 115 or 230 VAC	
For DIN-rail	1 x SPDT	D - 22.5 mm	DMC 01 C 724	DMC 01 C B48	DMC 01 C B23	
For DIN-rail	2 x SPDT	D - 45 mm	DMC 01 D 724	DMC 01 D B48	DMC 01 D B23	
Mounting	Output	Housing	Supply: 24 VDC	Supply: 24 VAC	Supply: 115 VAC	Supply: 230 VAC
Plug-in	1 x SPDT	P - Housing	PMC 01 C 724	PMC 01 C 024	PMC 01 C 115	PMC 01 C 230
Plug-in	2 x SPDT	P - Housing	PMC 01 D 724	PMC 01 D 024	PMC 01 D 115	PMC 01 D 230

Time Specifications

Time ranges Knob selectable	0.1 to 1 s 1 to 10 s 6 to 60 s 60 to 600 s 0.1 to 1 h 1 to 10 h 10 to 100 h	Reset Manual reset of time and/or relay Pulse duration Power supply interruption 1 relay versions: ≥ 700 ms 2 relays versions: ≥ 200 ms	Close the trigger contact ≥ 10 ms
Setting accuracy	$\leq 5\%$	PNP/NPN sensor supply output 1 relay versions: 15 VDC, 10 mA 2 relays versions: 24 VDC, 15 mA pins + and - or 6 and 7 pin + or 6 positive	
Repeatability	$\leq 0.2\%$	Namur sensor connection	8.2 VDC, 1k Ω pins + and S or 6 and 5 pin + or 6 positive
Time variation Within rated power supply Within ambient temperature	$\leq 0.05\%/V$ $\leq 0.2\%/^{\circ}C$		
External time setting Linear remote potentiometer Max length of pot. cable	10 k Ω 3 m		



Output Specifications

Output	1 or 2 x SPDT relay
Rated insulation voltage	250 VAC (RMS)
Contact Ratings (AgSnO₂)	μ
Resistive loads AC 1	8 A @ 250 VAC
DC 12	5 A @ 24 VDC
Small inductive loads AC 15	2.5 A @ 250 VAC
DC 13	2.5 A @ 24 VDC
Mechanical life	≥ 30 x 10 ⁶ operations
Electrical life	≥ 10 ⁵ operations (at 8 A, 250 V, cos φ = 1)
Operating frequency	< 7200 operations / h
Dielectric strength	
Dielectric voltage	2 kVAC (RMS)
Rated impulse withstand volt.	4 kV (1.2/50 μs)

Supply Specifications

Power supply	Overvoltage cat. III (IEC 60664, IEC 60038)
Rated operational voltage through terminals: A1, A2 or A1, A3 (DMC01)	
B48	24 or 48 VAC ± 15% 45 to 65 Hz
B23	115 or 230 VAC ± 15% 45 to 65 Hz
724	24 VDC ± 20%
2, 10 (PMC01)	
024	24 VAC ± 15%, 45 to 65 Hz
115	115 VAC ± 15%, 45 to 65 Hz
230	230 VAC ± 15%, 45 to 65 Hz
724	24 VDC ± 20%
Voltage interruption	≤ 10 ms
Rated operational power	
AC supply:	5 VA
DC supply:	2 W

General Specifications

Power ON delay	≤ 100 ms
Reaction time from trigger	
Delayed contact(s)	< 10 ms
Instantaneous contact	< 20 ms
Indication for	
Power supply ON	LED, green
Output relays ON	LED, yellow (flashing when timing)
Environment	(EN 60529)
Degree of protection	IP 20
Pollution degree	3 (DMC01), 2 (PMC01) (IEC 60664)
Operating temperature	-20 to 60 °C, R.H. < 95%
Storage temperature	-30 to 80 °C, R.H. < 95%
Housing	
Dimensions	DMC01C 22.5 x 80 x 99.5 mm DMC01D 45 x 80 x 99.5 mm PMC01 36 x 80 x 94 mm
Weight	120 to 260g depending on model
Screw terminals	(DMC01)
Tightening torque	Max 0.5 Nm according to IEC EN 60947
Approval	UL, CSA
CE Marking	Yes
EMC	
Immunity	Electromagnetic Compatibility
Emission	According to EN 61000-6-2 According to EN 61000-6-3
Timer Specifications	According to EN 61812-1

Function/Range/Time Setting

Adjust the function setting the DIP switches 1 to 6 as shown below (1 to 4 for DMC01Cxxx).

Note 1: DIP switch 5 must be kept ON when using PMC01Dxxx.

Note 2: DIP switch 6 does not have any effect on the PMC01Cxxx working mode.

To access the DIP switches open the grey plastic cover using a screwdriver as shown below.

Upper knob:
Selection of function:
Op - Delay on operate, manual start
Oa - Delay on operate, automatic and manual start

In - Interval, manual start
Ia - Interval, automatic and manual start
Nr - Interval with no time reset, manual start
Na - Interval with no time reset, automatic and manual start
Dr - Delay on release

Centre knob:
Time setting on relative

scale: 1 to 10 with respect to the chosen range.

Lower knob:
Setting of time range

External potentiometer (DMC01D, PMC01C):
Time setting on relative scale: 1 to 10 with respect to the chosen range.

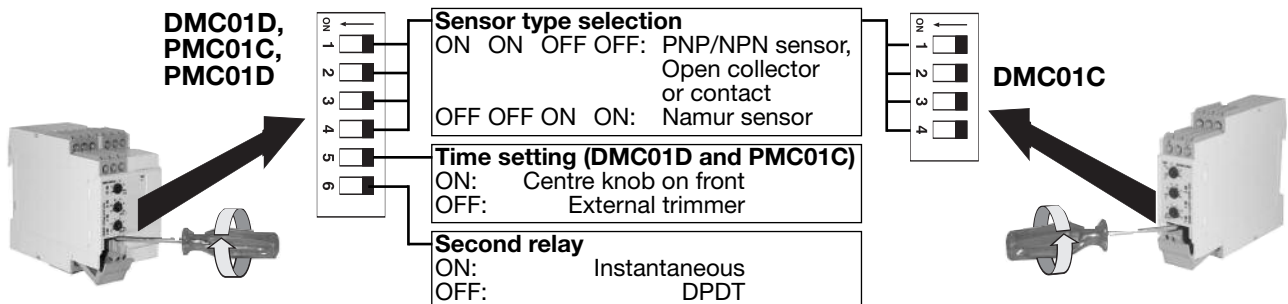



Mode of Operation

Function Op: Delay on operate, manual start

The time period begins as soon as the trigger contact is closed.
At the end of the set delay time the relay operates and doesn't release until the trigger contact is closed again or the power supply is disconnected. When the trigger contact is closed, the relay releases and a new time period starts.

Function Oa: Delay on operate, automatic and manual start

The time period begins as soon as the power supply is connected.
At the end of the set delay time the relay operates and doesn't release until the trigger contact is closed or the power supply is disconnected. When the trigger contact is closed, the relay releases and a new time period starts.

Function In: Interval, manual start

The relay operates and the time period begins as soon as the trigger contact is closed. The relay releases at the end of this period or when the power supply is disconnected. The relay operates again when the trigger contact is closed again. If the trigger contact is closed before the end of the delay time, the relay keeps ON and a new time period starts.

Function Ia: Interval, automatic and manual start

The relay operates and the time period begins as soon as the power supply is connected.
The relay releases at the end of this period or when the power supply is disconnected. The relay operates again when the trigger contact is closed. If the trigger contact is closed before the end of the delay time, the relay keeps ON and a new time period starts.

Function Nr: Interval with no time reset, manual start

The relay operates and the time period begins as soon as the trigger contact is closed. The relay releases at the end of this period or when the power supply is disconnected. The relay operates again when the trigger contact is closed again.

Function Na: Interval with no time reset, automatic and manual start

The relay operates and the time period begins as soon as the power supply is connected.
The relay releases at the end of this period or when the power supply is disconnected. The relay operates again when the trigger contact is closed.

Function Dr: Delay on release

The relay operates as soon as the trigger contact is closed. The time period begins when the trigger contact is opened. The relay releases at the end of the set delay time or when the power supply is disconnected. The relay operates again when the input contact is closed again. If it is closed before the end of the delay time the relay keeps ON, a new time period begins as soon as the contact is opened again.

Example 1: Delay on operate with remote control time setting:

Using the delay on operate function, DMC01D or PMC01C can be used to set the working delay of an equipment (i.e. a pump) by a knob placed on a panel. It is only necessary to connect an external potentiometer to the suitable pins (T1, T2, T3 for DMC01D or 8, 9, 11 for PMC01C) and mount the knob on the control panel.

Note:

The external potentiometer must be connected before the product operates. The cable length must be below 3 m

Example 2: Interval with NPN or Namur proximity sensor.

Using the Interval function and a NPN or Namur proximity sensor, DMC01 and PMC01 can be used to monitor the actual presence of an object (i.e. a can) in the right place on a conveyor belt. In fact the sensor triggers the timer each time it detects an object on the belt, so the relay keeps ON as long as there is no gap on the belt. As soon as there is a gap on the belt, the relay switches OFF and an alarm can be activated.

Yellow LED working mode

- Timing:
 - Slow blinking
- Relay ON:
 - See operation diagrams
- Incorrect knobs position:
 - Fast blinking

Operation Diagrams

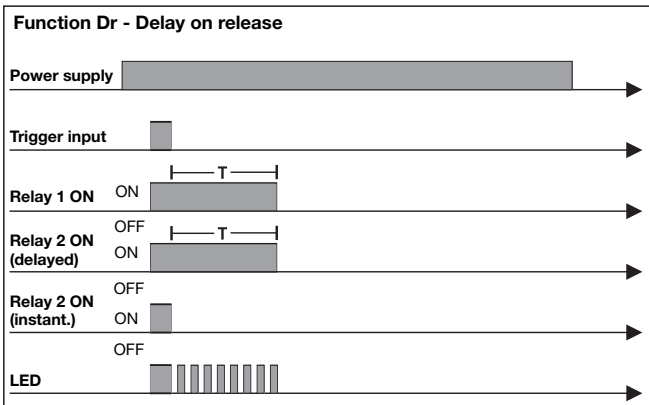
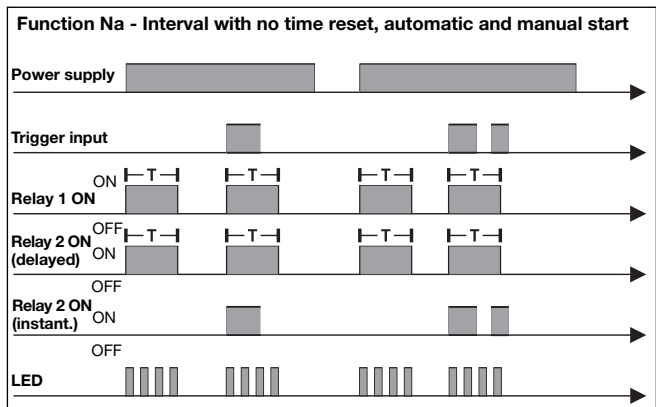
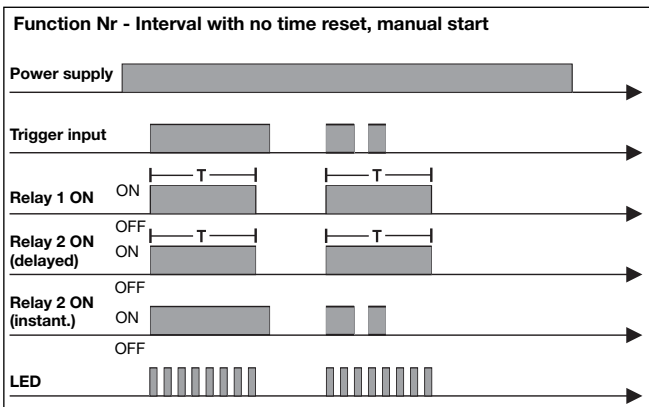
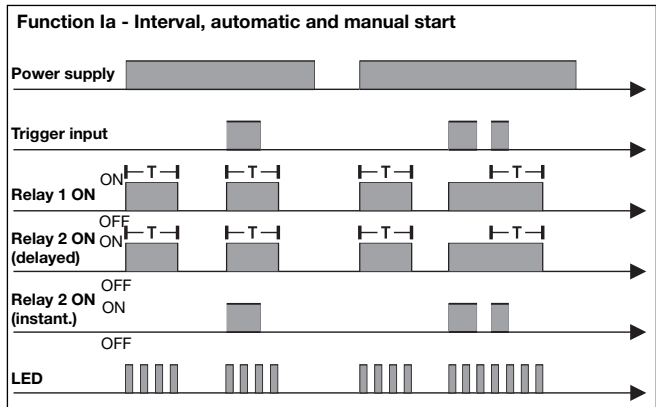
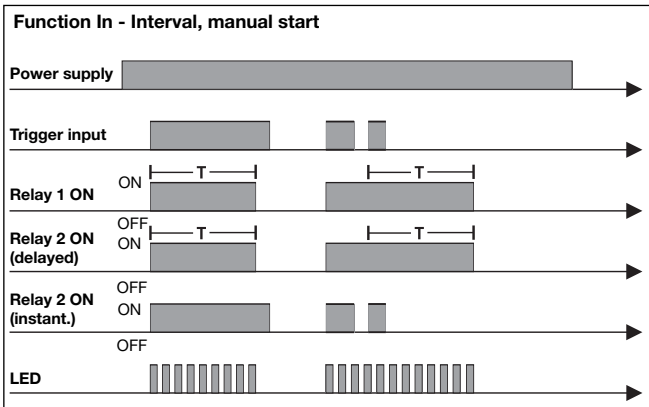
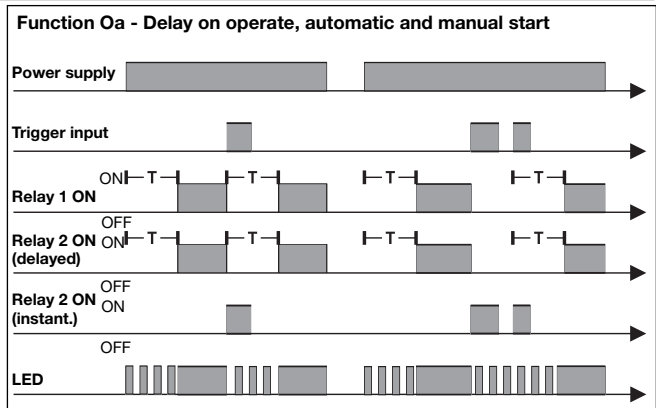
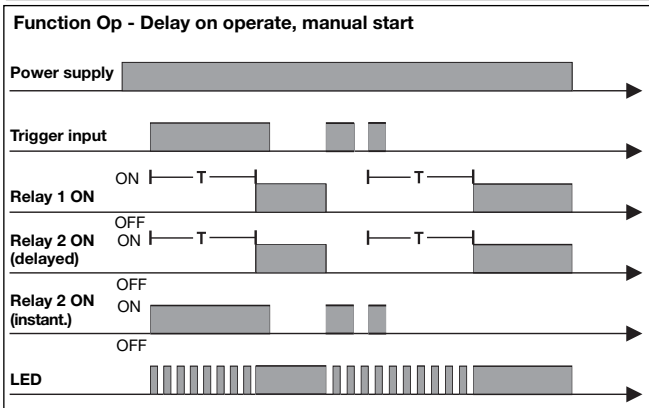

Wiring Diagrams

DMC01C - Contact input

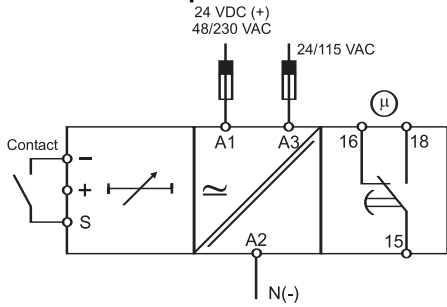

PMC01C - Contact input

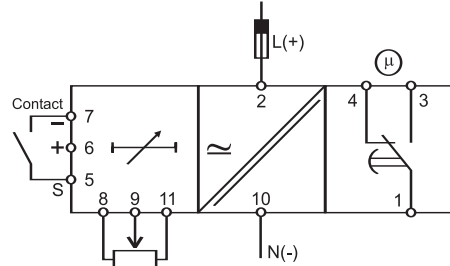

DMC01C - Open collector input

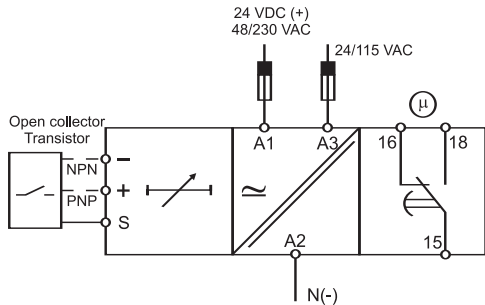

PMC01C - Open collector input

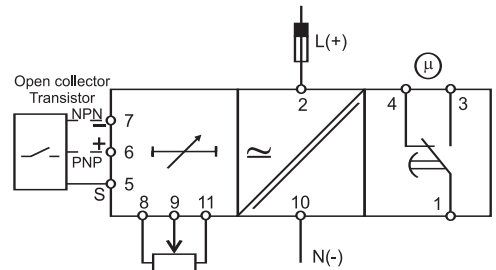

DMC01D - PNP / NPN sensor input

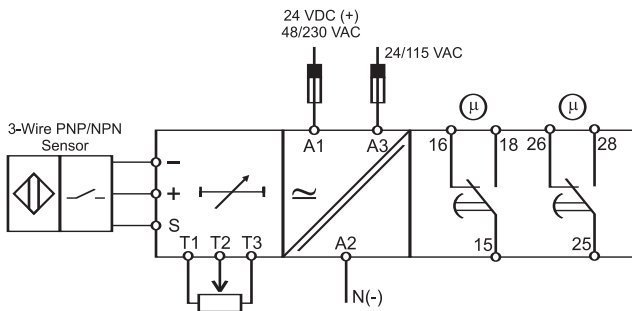

PMC01D - PNP / NPN sensor input

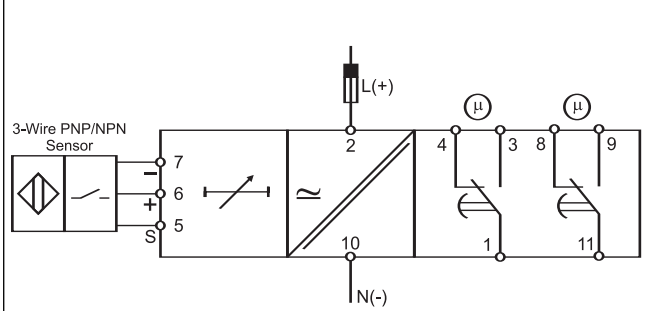

DMC01D - Namur sensor input

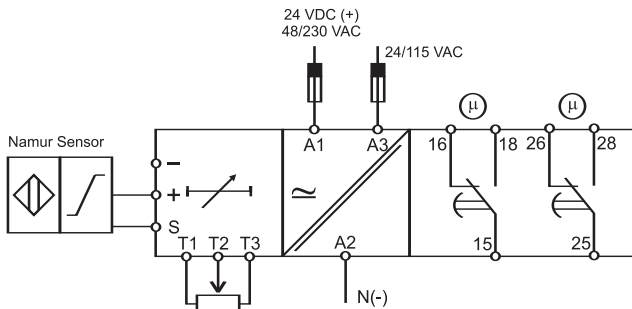

PMC01D - Namur sensor input

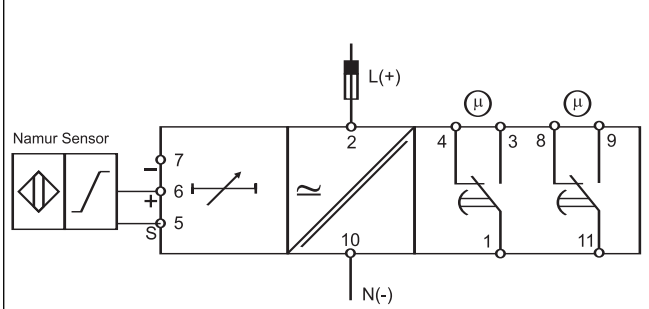

Dimensions

