



Chipsmall Limited consists of a professional team with an average of over 10 year of expertise in the distribution of electronic components. Based in Hongkong, we have already established firm and mutual-benefit business relationships with customers from,Europe,America and south Asia,supplying obsolete and hard-to-find components to meet their specific needs.

With the principle of “Quality Parts,Customers Priority,Honest Operation,and Considerate Service”,our business mainly focus on the distribution of electronic components. Line cards we deal with include Microchip,ALPS,ROHM,Xilinx,Pulse,ON,Everlight and Freescale. Main products comprise IC,Modules,Potentiometer,IC Socket,Relay,Connector.Our parts cover such applications as commercial,industrial, and automotives areas.

We are looking forward to setting up business relationship with you and hope to provide you with the best service and solution. Let us make a better world for our industry!



## Contact us

Tel: +86-755-8981 8866 Fax: +86-755-8427 6832

Email & Skype: info@chipsmall.com Web: www.chipsmall.com

Address: A1208, Overseas Decoration Building, #122 Zhenhua RD., Futian, Shenzhen, China



## Product Summary

Device	$V_{(BR)DSS}$	$R_{DS(ON)}$ max	$I_D$ max $T_A = +25^\circ C$
Q1	30	$0.4\Omega @ V_{GS} = 10V$	0.65A
		$0.7\Omega @ V_{GS} = 4.5V$	0.52A
Q2	-30	$0.9\Omega @ V_{GS} = -10V$	-0.45A
		$1.7\Omega @ V_{GS} = -4.5V$	-0.33A

## Description and Applications

This MOSFET is designed to minimize the on-state resistance ( $R_{DS(ON)}$ ) and yet maintain superior switching performance, making it ideal for high efficiency power management applications.

- Motor Control
- Power Management Functions
- DC-DC Converters

## Features and Benefits

- Low On-Resistance
- Low Input Capacitance
- Fast Switching Speed
- **ESD Protected Gate**
- **Totally Lead-Free & Fully RoHS Compliant (Notes 1 & 2)**
- **Halogen and Antimony Free. "Green" Device (Note 3)**

## Mechanical Data

- Case: SOT363
- Case Material: Molded Plastic, "Green" Molding Compound. UL Flammability Classification Rating 94V-0
- Moisture Sensitivity: Level 1 per J-STD-020
- Terminal Connections Indicator: See Diagram
- Terminals: Finish — Matte Tin Annealed over Copper Leadframe. Solderable per MIL-STD-202, Method 208  $\text{e3}$
- Weight: 0.027 grams (Approximate)

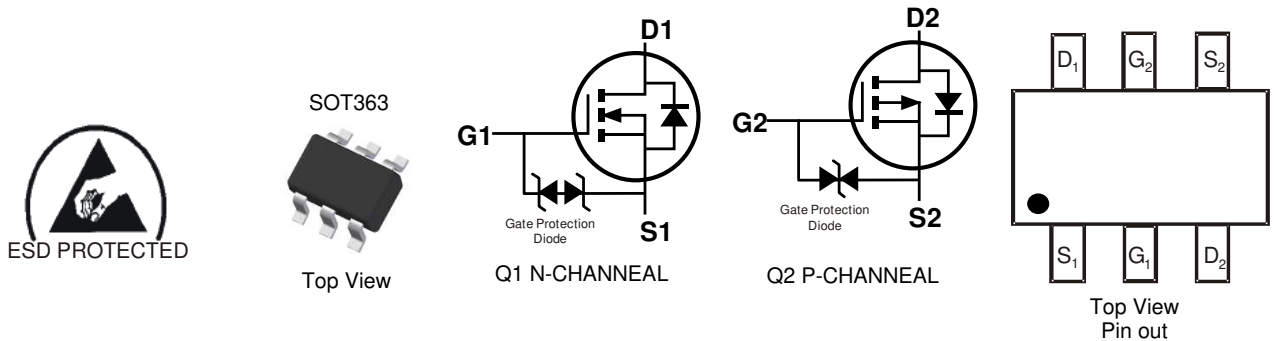

## Ordering Information (Note 4)

Part Number	Case	Packaging
DMC3400SDW-7	SOT363	3000/Tape & Reel
DMC3400SDW-13	SOT363	10000/Tape & Reel

- Notes:
1. No purposely added lead. Fully EU Directive 2002/95/EC (RoHS) & 2011/65/EU (RoHS 2) compliant.
  2. See [http://www.diodes.com/quality/lead\\_free.html](http://www.diodes.com/quality/lead_free.html) for more information about Diodes Incorporated's definitions of Halogen- and Antimony-free, "Green" and Lead-free.
  3. Halogen- and Antimony-free "Green" products are defined as those which contain <900ppm bromine, <900ppm chlorine (<1500ppm total Br + Cl) and <1000ppm antimony compounds.
  4. For packaging details, go to our website at <http://www.diodes.com/products/packages.html>.

## Marking Information

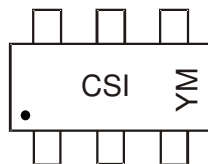

CSI = Product Type Marking Code  
 YM = Date Code Marking  
 Y or  $\bar{Y}$  = Year (ex: B = 2014)  
 M = Month (ex: 9 = September)

### Date Code Key

Year	2014	2015	2016	2017	2018	2019	2020
Code	B	C	D	E	F	G	H

Month	Jan	Feb	Mar	Apr	May	Jun	Jul	Aug	Sep	Oct	Nov	Dec
Code	1	2	3	4	5	6	7	8	9	O	N	D

**Maximum Ratings** (@T<sub>A</sub> = +25°C, unless otherwise specified.)

Characteristic			Symbol	Value_Q1	Value_Q2	Units
Drain-Source Voltage			V <sub>DSS</sub>	30	-30	V
Gate-Source Voltage			V <sub>GSS</sub>	±20	±20	V
Continuous Drain Current (Note 6) V <sub>GS</sub> = 10V	Steady State	T <sub>A</sub> = +25°C	I <sub>D</sub>	0.65	-0.45	A
		T <sub>A</sub> = +70°C		0.50	-0.36	
Maximum Continuous Body Diode Forward Current (Note 6)			I <sub>S</sub>	0.4	-0.35	A
Pulsed Drain Current (10µs Pulse, Duty Cycle = 1%)			I <sub>DM</sub>	4	-3	A

**Thermal Characteristics** (@T<sub>A</sub> = +25°C, unless otherwise specified.)

Characteristic			Symbol	Value	Units
Total Power Dissipation (Note 5)			P <sub>D</sub>	0.31	W
Thermal Resistance, Junction to Ambient (Note 5)		Steady State	R <sub>θJA</sub>	406	°C/W
Total Power Dissipation (Note 6)			P <sub>D</sub>	0.39	W
Thermal Resistance, Junction to Ambient (Note 6)		Steady State	R <sub>θJA</sub>	319	°C/W
Thermal Resistance, Junction to Case			R <sub>θJC</sub>	126	°C/W
Operating and Storage Temperature Range			T <sub>J</sub> , T <sub>STG</sub>	-55 to +150	°C

**Electrical Characteristics – N Channel – Q1** (@T<sub>A</sub> = +25°C, unless otherwise specified.)

Characteristic	Symbol	Min	Typ	Max	Unit	Test Condition
<b>OFF CHARACTERISTICS (Note 7)</b>						
Drain-Source Breakdown Voltage	BV <sub>DSS</sub>	30	-	-	V	V <sub>GS</sub> = 0V, I <sub>D</sub> = 250µA
Zero Gate Voltage Drain Current	I <sub>DSS</sub>	-	-	1	µA	V <sub>DS</sub> = 24V, V <sub>GS</sub> = 0V
Gate-Source Leakage	I <sub>GSS</sub>	-	-	±10	µA	V <sub>GS</sub> = ±16V, V <sub>DS</sub> = 0V
<b>ON CHARACTERISTICS (Note 7)</b>						
Gate Threshold Voltage	V <sub>GS(TH)</sub>	0.8	-	1.6	V	V <sub>DS</sub> = V <sub>GS</sub> , I <sub>D</sub> = 250µA
Static Drain-Source On-Resistance	R <sub>DSON</sub>	-	0.2	0.4	Ω	V <sub>GS</sub> = 10V, I <sub>D</sub> = 0.59A
		-	0.3	0.7		V <sub>GS</sub> = 4.5V, I <sub>D</sub> = 0.2A
Diode Forward Voltage	V <sub>SD</sub>	-	0.8	1.2	V	V <sub>GS</sub> = 0V, I <sub>S</sub> = 0.23A
<b>DYNAMIC CHARACTERISTICS (Note 8)</b>						
Input Capacitance	C <sub>ISS</sub>	-	55	-	pF	V <sub>DS</sub> = 15V, V <sub>GS</sub> = 0V, f = 1.0MHz
Output Capacitance	C <sub>OSS</sub>	-	8.5	-	pF	
Reverse Transfer Capacitance	C <sub>RSS</sub>	-	6.5	-	pF	
Gate Resistance	R <sub>g</sub>	-	92	-	Ω	V <sub>DS</sub> = V <sub>GS</sub> = 0V, f = 1.0MHz
Total Gate Charge (V <sub>GS</sub> = 4.5V)	Q <sub>g</sub>	-	0.6	-	nC	V <sub>DS</sub> = 10V, I <sub>D</sub> = 250mA
Total Gate Charge (V <sub>GS</sub> = 10V)	Q <sub>g</sub>	-	1.4	-	nC	
Gate-Source Charge	Q <sub>gs</sub>	-	0.2	-	nC	
Gate-Drain Charge	Q <sub>gd</sub>	-	0.1	-	nC	
Turn-On Delay Time	t <sub>D(ON)</sub>	-	3.8	-	ns	V <sub>GS</sub> = 10V, V <sub>DS</sub> = 30V, I <sub>D</sub> = 100mA, R <sub>G</sub> = 1Ω
Turn-On Rise Time	t <sub>R</sub>	-	3.5	-	ns	
Turn-Off Delay Time	t <sub>D(OFF)</sub>	-	25.2	-	ns	
Turn-Off Fall Time	t <sub>F</sub>	-	18.8	-	ns	

**Electrical Characteristics – P Channel – Q2** (@T<sub>A</sub> = +25°C, unless otherwise specified.)

Characteristic	Symbol	Min	Typ	Max	Unit	Test Condition
<b>OFF CHARACTERISTICS (Note 7)</b>						
Drain-Source Breakdown Voltage	BV <sub>DSS</sub>	-30	-	-	V	V <sub>GS</sub> = 0V, I <sub>D</sub> = -250μA
Zero Gate Voltage Drain Current	I <sub>DSS</sub>	-	-	-1	μA	V <sub>DS</sub> = -24V, V <sub>GS</sub> = 0V
Gate-Source Leakage	I <sub>GSS</sub>	-	-	±10	μA	V <sub>GS</sub> = ±16V, V <sub>DS</sub> = 0V
<b>ON CHARACTERISTICS (Note 7)</b>						
Gate Threshold Voltage	V <sub>GS(TH)</sub>	-1	-	-2.6	V	V <sub>DS</sub> = V <sub>GS</sub> , I <sub>D</sub> = -250μA
Static Drain-Source On-Resistance	R <sub>DS(ON)</sub>	-	0.36	0.9	Ω	V <sub>GS</sub> = -10V, I <sub>D</sub> = -0.42A
		-	0.57	1.7		V <sub>GS</sub> = -4.5V, I <sub>D</sub> = -0.2A
Diode Forward Voltage	V <sub>SD</sub>	-	-0.8	-1.2	V	V <sub>GS</sub> = 0V, I <sub>S</sub> = -0.23A
<b>DYNAMIC CHARACTERISTICS (Note 8)</b>						
Input Capacitance	C <sub>iss</sub>	-	54	-	pF	V <sub>DS</sub> = -15V, V <sub>GS</sub> = 0V, f = 1.0MHz
Output Capacitance	C <sub>oss</sub>	-	10	-	pF	
Reverse Transfer Capacitance	C <sub>rss</sub>	-	8.3	-	pF	
Gate Resistance	R <sub>g</sub>	-	240	-	Ω	V <sub>DS</sub> = V <sub>GS</sub> = 0V, f = 1.0MHz
Total Gate Charge (V <sub>GS</sub> = -4.5V)	Q <sub>g</sub>	-	0.6	-	nC	V <sub>DS</sub> = -10V, I <sub>D</sub> = -0.24A
Total Gate Charge (V <sub>GS</sub> = -10V)	Q <sub>g</sub>	-	1.3	-	nC	
Gate-Source Charge	Q <sub>gs</sub>	-	0.2	-	nC	
Gate-Drain Charge	Q <sub>gd</sub>	-	0.2	-	nC	
Turn-On Delay Time	t <sub>D(ON)</sub>	-	5.7	-	ns	V <sub>GS</sub> = -10V, V <sub>DD</sub> = -15V, I <sub>D</sub> = -0.5A, R <sub>G</sub> = 1Ω
Turn-On Rise Time	t <sub>R</sub>	-	8.8	-	ns	
Turn-Off Delay Time	t <sub>D(OFF)</sub>	-	35	-	ns	
Turn-Off Fall Time	t <sub>F</sub>	-	19	-	ns	

- Notes:
5. Device mounted on FR-4 PCB, with minimum recommended pad layout.
  6. Device mounted on 1" x 1" FR-4 PCB with high coverage 2oz. Copper, single sided.
  7. Short duration pulse test used to minimize self-heating effect.
  8. Guaranteed by design. Not subject to product testing.

**Typical Characteristics - N-CHANNEL**

NEW PRODUCT

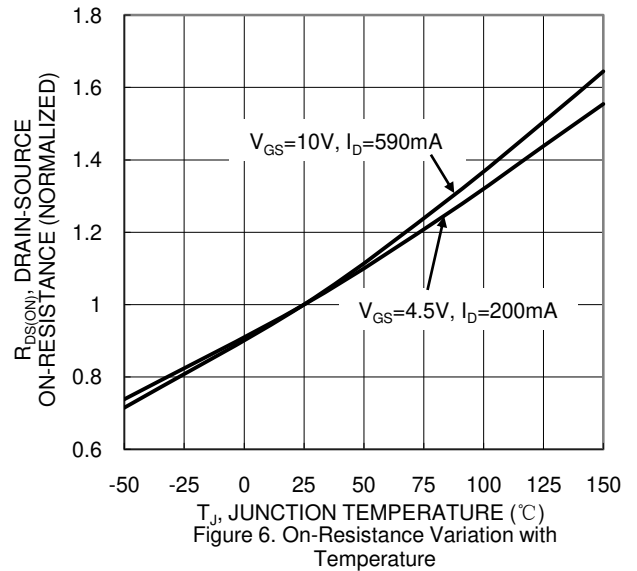
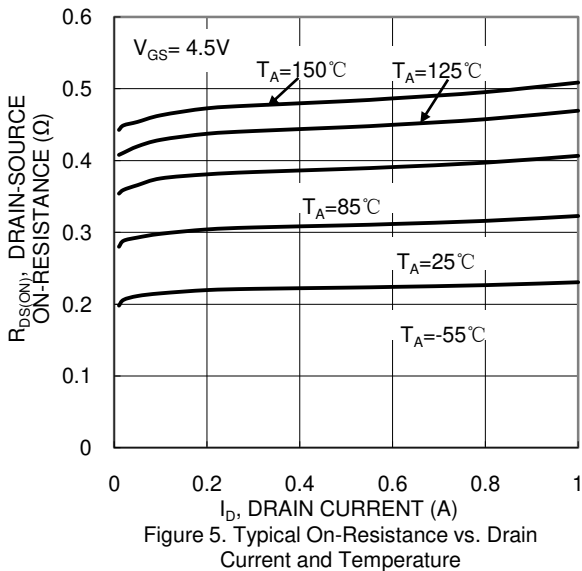
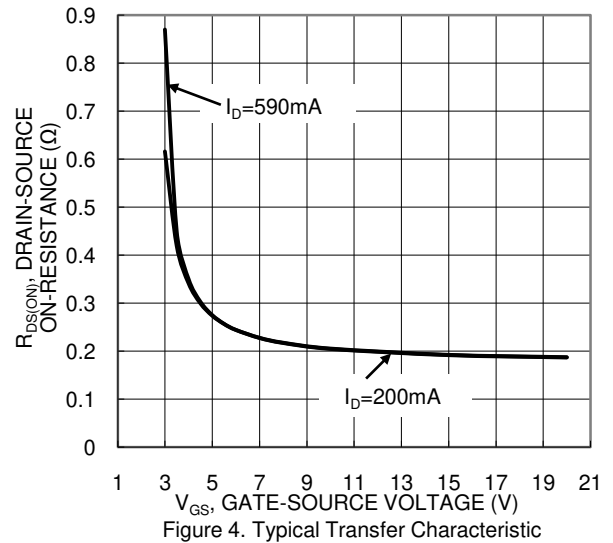
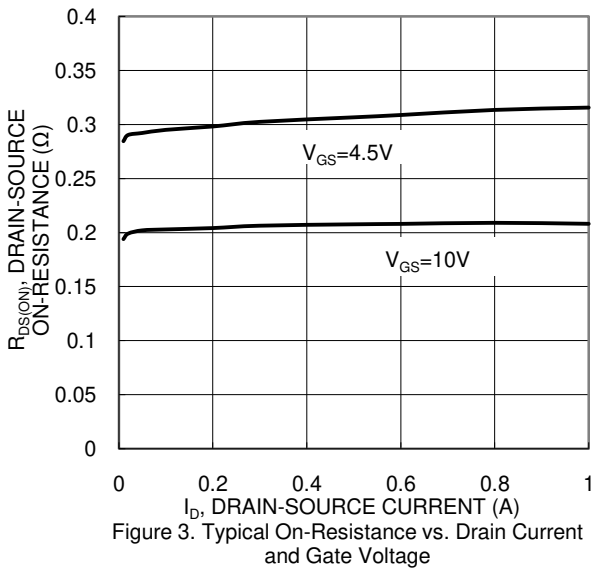
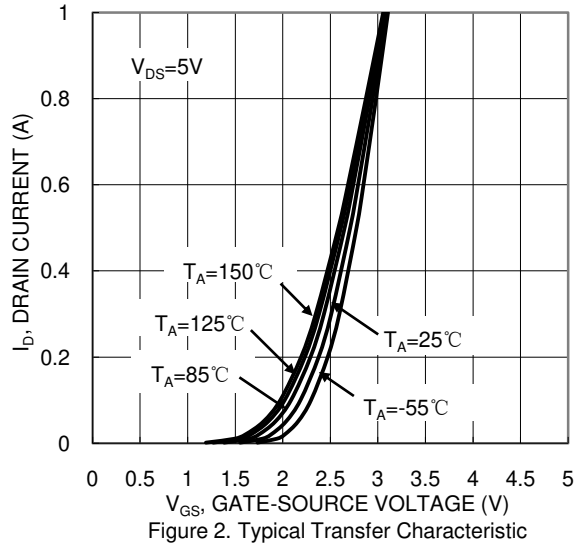
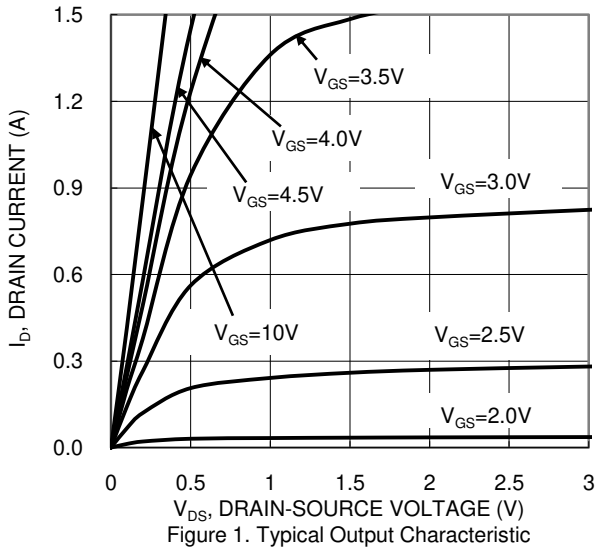

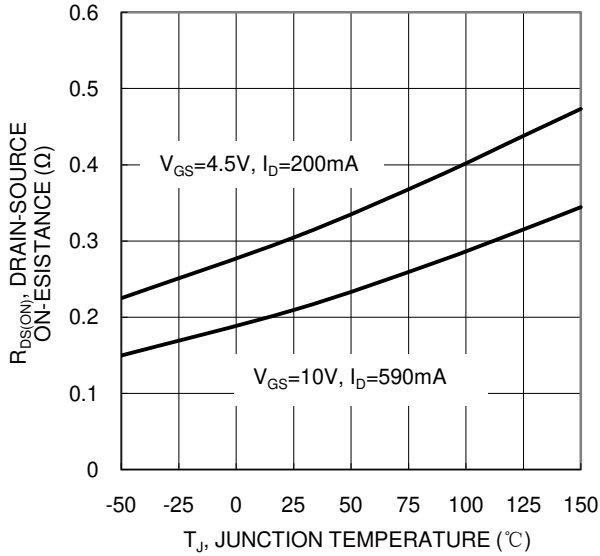

Figure 7. On-Resistance Variation with Temperature

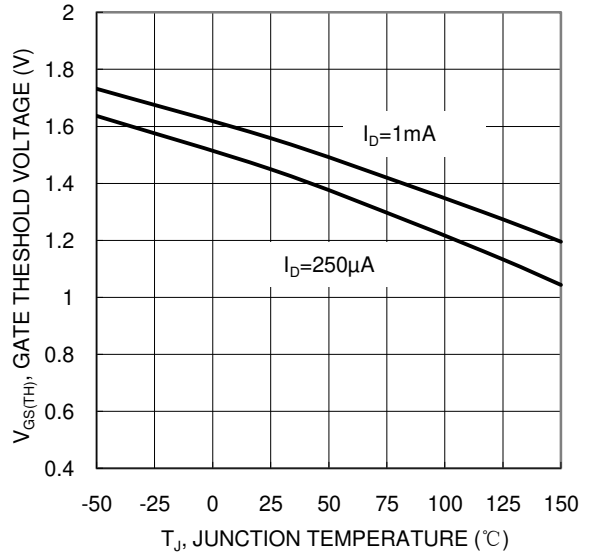

Figure 8. Gate Threshold Variation vs. Junction Temperature

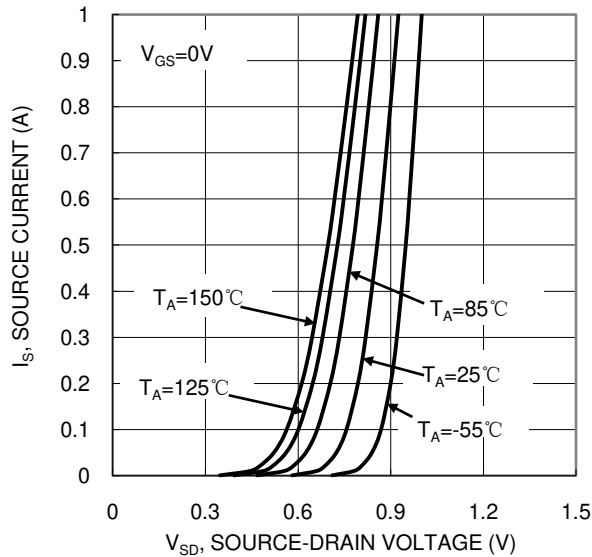

Figure 9. Diode Forward Voltage vs. Current

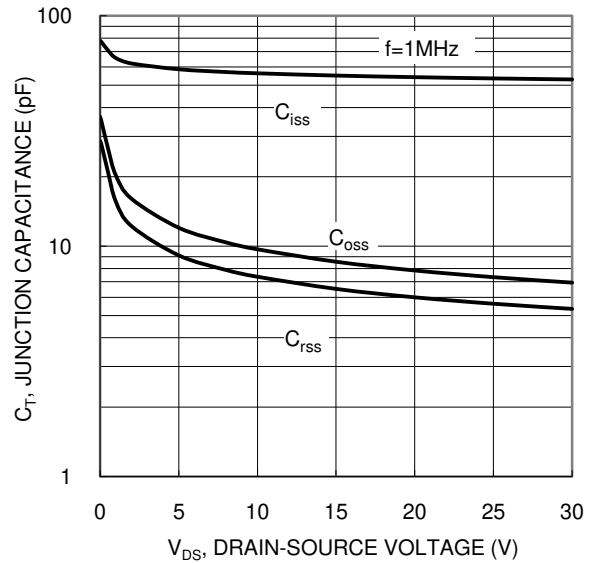

Figure 10. Typical Junction Capacitance

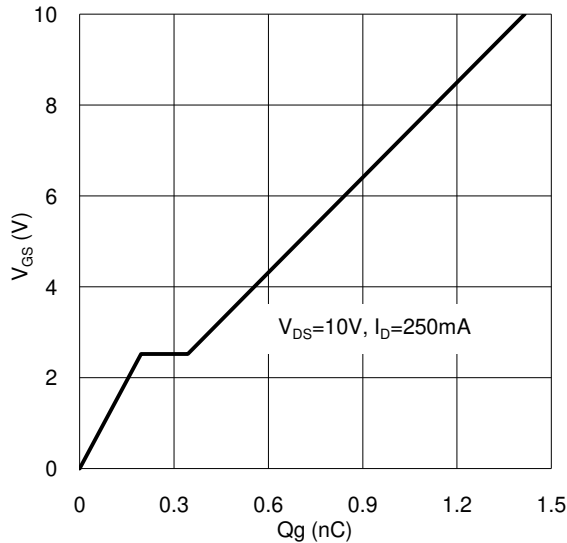

Figure 11. Gate Charge

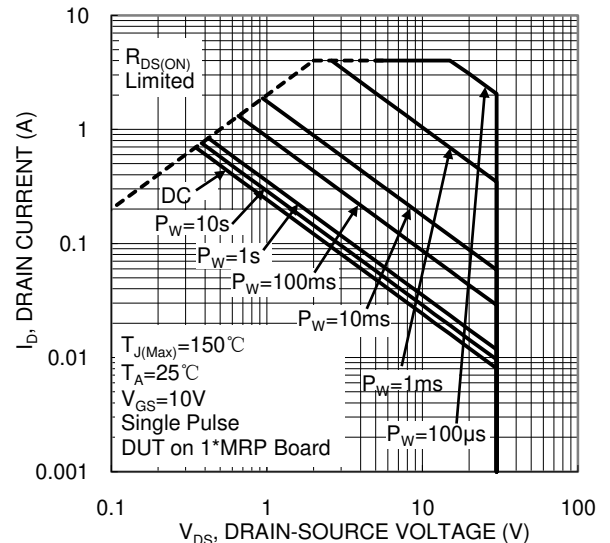
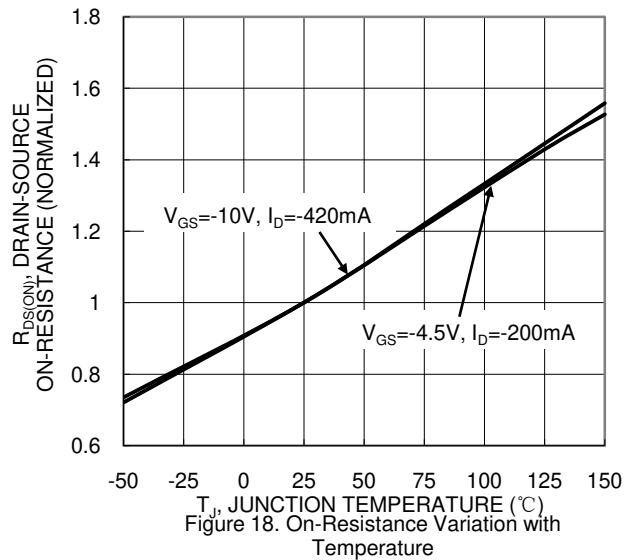
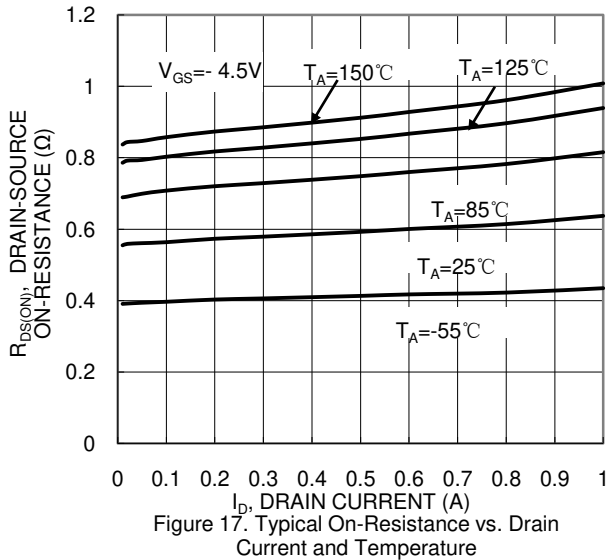
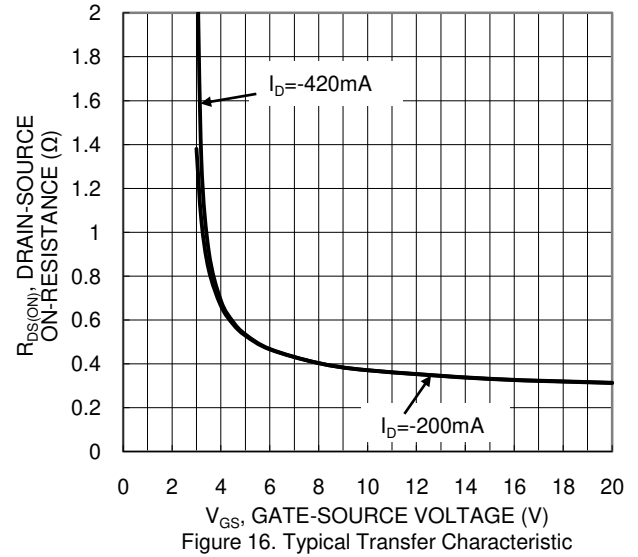
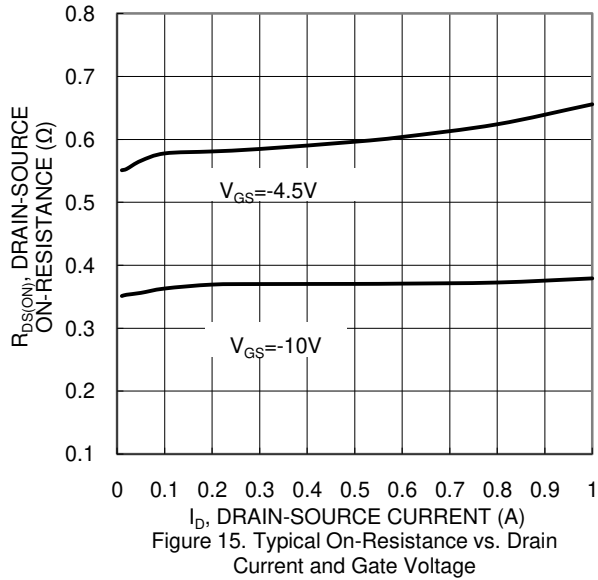
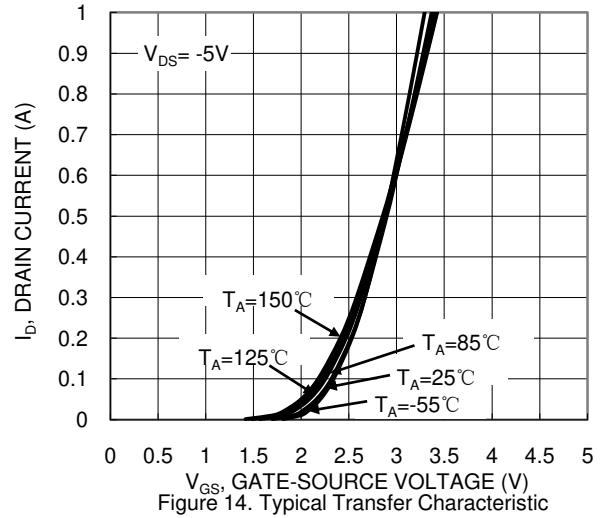
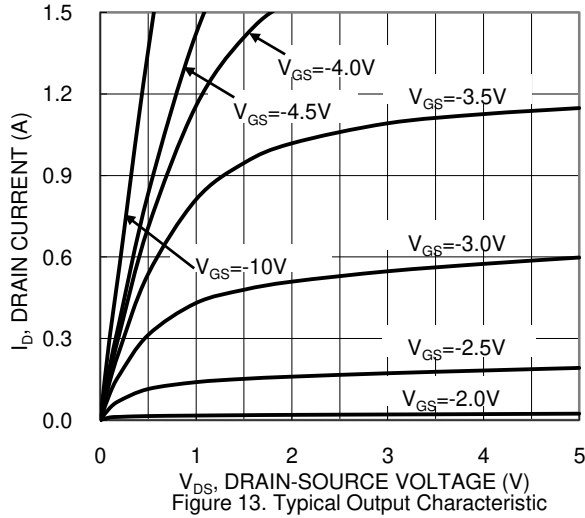

Figure 12. SOA, Safe Operation Area

**Typical Characteristics - P-CHANNEL**

NEW PRODUCT



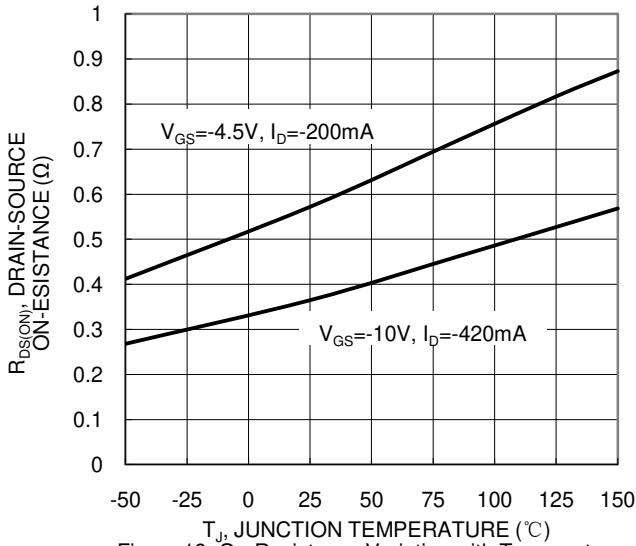

Figure 19. On-Resistance Variation with Temperature

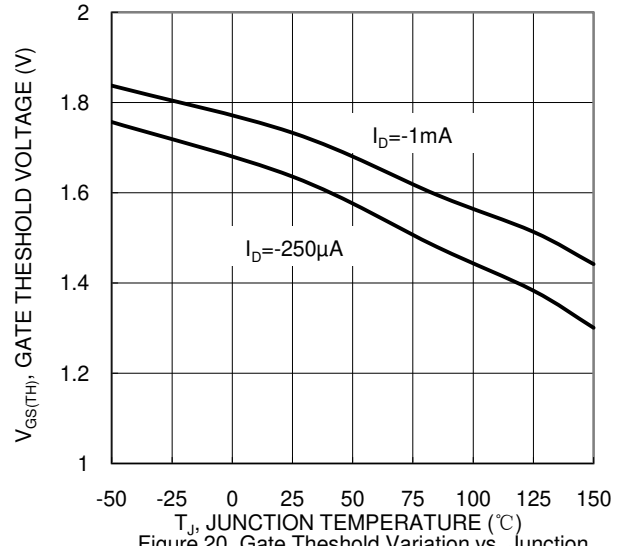

Figure 20. Gate Threshold Variation vs. Junction Temperature

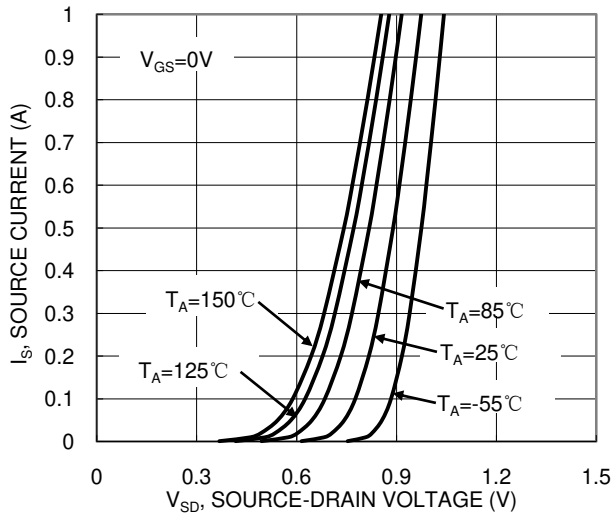

Figure 21. Diode Forward Voltage vs. Current

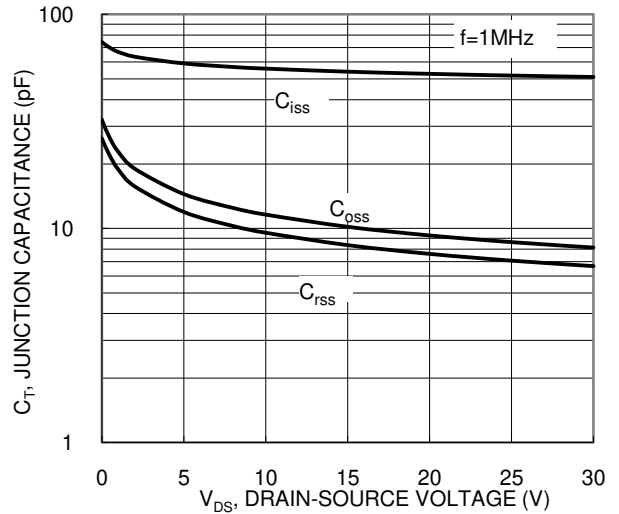

Figure 22. Typical Junction Capacitance

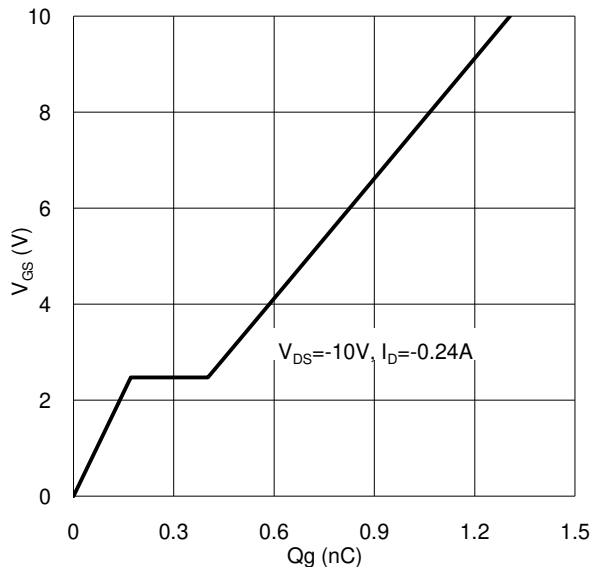

Figure 23. Gate Charge

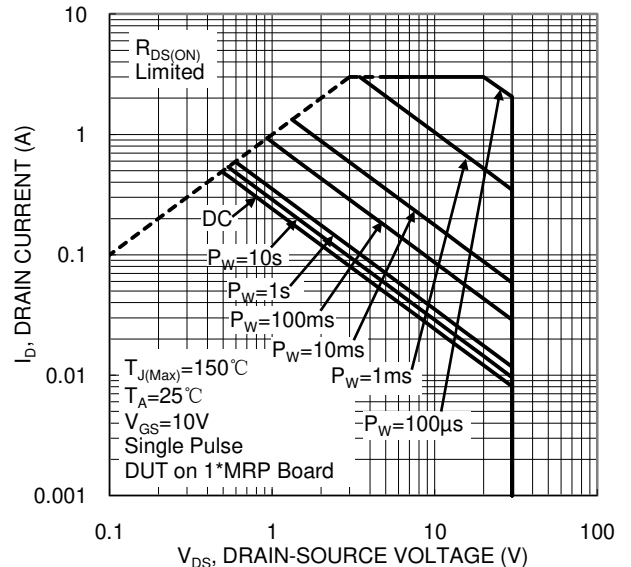
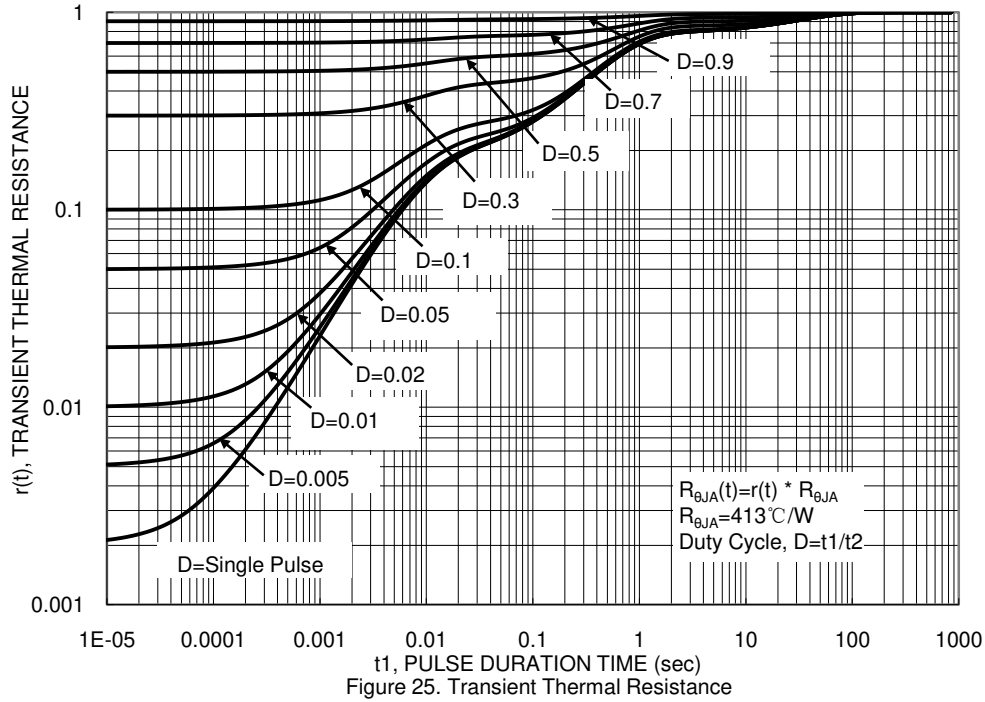

Figure 24. SOA, Safe Operation Area





**Package Outline Dimensions**

Please see AP02002 at <http://www.diodes.com/datasheets/ap02002.pdf> for the latest version.

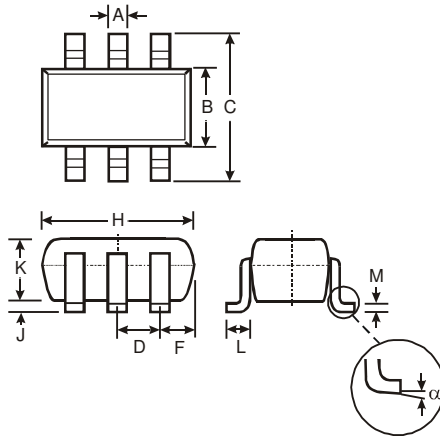

SOT363			
Dim	Min	Max	Typ
A	0.10	0.30	0.25
B	1.15	1.35	1.30
C	2.00	2.20	2.10
D	0.65 Typ		
F	0.40	0.45	0.425
H	1.80	2.20	2.15
J	0	0.10	0.05
K	0.90	1.00	1.00
L	0.25	0.40	0.30
M	0.10	0.22	0.11
α	0°	8°	-
<b>All Dimensions in mm</b>			

**Suggested Pad Layout**

Please see AP02001 at <http://www.diodes.com/datasheets/ap02001.pdf> for the latest version.

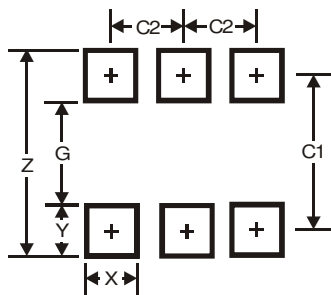

Dimensions	Value (in mm)
Z	2.5
G	1.3
X	0.42
Y	0.6
C1	1.9
C2	0.65

**IMPORTANT NOTICE**

DIODES INCORPORATED MAKES NO WARRANTY OF ANY KIND, EXPRESS OR IMPLIED, WITH REGARDS TO THIS DOCUMENT, INCLUDING, BUT NOT LIMITED TO, THE IMPLIED WARRANTIES OF MERCHANTABILITY AND FITNESS FOR A PARTICULAR PURPOSE (AND THEIR EQUIVALENTS UNDER THE LAWS OF ANY JURISDICTION).

Diodes Incorporated and its subsidiaries reserve the right to make modifications, enhancements, improvements, corrections or other changes without further notice to this document and any product described herein. Diodes Incorporated does not assume any liability arising out of the application or use of this document or any product described herein; neither does Diodes Incorporated convey any license under its patent or trademark rights, nor the rights of others. Any Customer or user of this document or products described herein in such applications shall assume all risks of such use and will agree to hold Diodes Incorporated and all the companies whose products are represented on Diodes Incorporated website, harmless against all damages.

Diodes Incorporated does not warrant or accept any liability whatsoever in respect of any products purchased through unauthorized sales channel. Should Customers purchase or use Diodes Incorporated products for any unintended or unauthorized application, Customers shall indemnify and hold Diodes Incorporated and its representatives harmless against all claims, damages, expenses, and attorney fees arising out of, directly or indirectly, any claim of personal injury or death associated with such unintended or unauthorized application.

Products described herein may be covered by one or more United States, international or foreign patents pending. Product names and markings noted herein may also be covered by one or more United States, international or foreign trademarks.

**LIFE SUPPORT**

Diodes Incorporated products are specifically not authorized for use as critical components in life support devices or systems without the express written approval of the Chief Executive Officer of Diodes Incorporated. As used herein:

A. Life support devices or systems are devices or systems which:

1. are intended to implant into the body, or
2. support or sustain life and whose failure to perform when properly used in accordance with instructions for use provided in the labeling can be reasonably expected to result in significant injury to the user.

B. A critical component is any component in a life support device or system whose failure to perform can be reasonably expected to cause the failure of the life support device or to affect its safety or effectiveness.

Customers represent that they have all necessary expertise in the safety and regulatory ramifications of their life support devices or systems, and acknowledge and agree that they are solely responsible for all legal, regulatory and safety-related requirements concerning their products and any use of Diodes Incorporated products in such safety-critical, life support devices or systems, notwithstanding any devices- or systems-related information or support that may be provided by Diodes Incorporated. Further, Customers must fully indemnify Diodes Incorporated and its representatives against any damages arising out of the use of Diodes Incorporated products in such safety-critical, life support devices or systems.

Copyright © 2015, Diodes Incorporated

[www.diodes.com](http://www.diodes.com)