



Chipsmall Limited consists of a professional team with an average of over 10 year of expertise in the distribution of electronic components. Based in Hongkong, we have already established firm and mutual-benefit business relationships with customers from,Europe,America and south Asia,supplying obsolete and hard-to-find components to meet their specific needs.

With the principle of “Quality Parts,Customers Priority,Honest Operation,and Considerate Service”,our business mainly focus on the distribution of electronic components. Line cards we deal with include Microchip,ALPS,ROHM,Xilinx,Pulse,ON,Everlight and Freescale. Main products comprise IC,Modules,Potentiometer,IC Socket,Relay,Connector.Our parts cover such applications as commercial,industrial, and automotives areas.

We are looking forward to setting up business relationship with you and hope to provide you with the best service and solution. Let us make a better world for our industry!



Contact us

Tel: +86-755-8981 8866 Fax: +86-755-8427 6832

Email & Skype: info@chipsmall.com Web: www.chipsmall.com

Address: A1208, Overseas Decoration Building, #122 Zhenhua RD., Futian, Shenzhen, China



DATA SHEET

DME, DMF, DMJ Series: Silicon Beam-Lead Schottky Mixer Diode (Singles, Pairs, and Quads) Bondable Beam-Lead Devices

Applications

- Microwave Integrated Circuits
- Mixers
- Detectors

Features

- Low 1/f noise
- Low intermodulation distortion
- Statistical Process Control wafer fabrication



Skyworks Green™ products are compliant with all applicable legislation and are halogen-free. For additional information, refer to *Skyworks Definition of Green™*, document number SQ04-0074.

Description

Skyworks beam-lead silicon Schottky barrier mixer diodes are designed for applications through 40 GHz. The beam-lead design reduces the problem of bonding to the very small area characteristic of low capacitance junctions.

Beam-lead Schottky barrier mixer diodes are made by the deposition of a suitable barrier metal on an epitaxial silicon substrate to form the junction. The process and choice of materials result in low series resistance with a narrow spread of capacitance values for close impedance control.

A variety of forward voltages are available ranging from low values for low, or starved, local oscillator drive levels to high values for high drive, low distortion mixer applications. Capacitance ranges and series resistances are comparable with the beam-lead devices that are available up to, and including, the Ka-band. These diodes are well suited for use in Microwave Integrated Circuits (MICs).

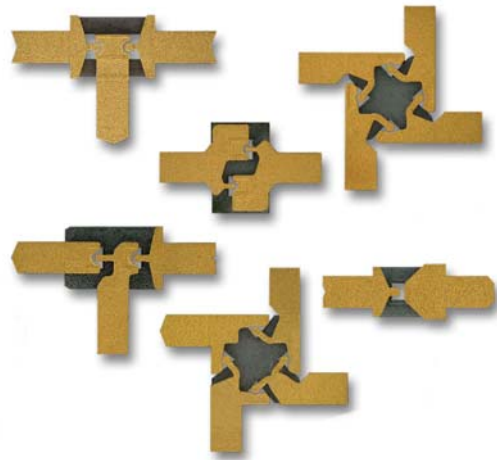

Beam-lead Schottky barrier diodes are categorized by universal mixer applications in six frequency ranges: S, C, X, Ku, K, and Ka bands as noted in Table 1. They can also be used as modulators and high-speed switches.

Beam-lead diodes are suited for balanced mixers, due to their low parasitics and uniformity.

Table 1. Frequency Table

Frequency Band	Frequency (GHz)
S	2 to 4
C	4 to 8
X	8.2 to 12.4
Ku	12.4 to 18.0
K	18.0 to 26.5
Ka	26.5 to 40.0

Electrical and Mechanical Specifications

The absolute maximum ratings of the DME, DMF, and DMJ series of Schottky mixer diodes are provided in Table 2. Electrical and physical specifications are provided in Tables 3 through 8.

Typical performance characteristics are shown in Figures 1 through 3. Typical mixer circuits are shown in Figure 4.

Table 2. Absolute Maximum Ratings (Note 1)

Parameter	Symbol	Minimum	Typical	Maximum	Units
Maximum current	I _{max}			100	mA
Power dissipation (continuous wave)	P _d			75	mW/junction
Storage temperature	T _{STG}	-65		+175	°C
Operating temperature	T _A	-65		+175	°C

Note 1: Exposure to maximum rating conditions for extended periods may reduce device reliability. There is no damage to device with only one parameter set at the limit and all other parameters set at or below their nominal value. Exceeding any of the limits listed here may result in permanent damage to the device.

CAUTION: Although these devices are designed to be as robust as possible, electrostatic discharge (ESD) can damage them. These devices must be protected at all times from ESD. Static charges may easily produce potentials of several kilovolts on the human body or equipment, which can discharge without detection. Industry-standard ESD precautions should be used at all times.

Table 3. Electrical Specifications: Beam-Lead Single N-Type Low, Medium, High Drive Schottky Diodes

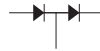

Part Number	Frequency Band	C _J @ 0 V, 1 MHz (pF)	Rs @ 5 mA (Ω)	V _B @ 10 μA (V)	V _F @ 1 mA (mV)	Drive Level	Outline Drawing
			Max.	Min.			
DMF2820-000	S, C	0.30 to 0.50	5	2	200 to 260	low	491-011
DME2127-000	S, C	0.30 to 0.50	5	3	300 to 400	medium	491-011
DMJ2823-000	S, C	0.30 to 0.50	5	4	500 to 600	high	491-011
DMF2821-000	X	0.15 to 0.30	8	2	220 to 300	low	491-011
DME2957-000	X	0.15 to 0.30	8	3	325 to 425	medium	491-011
DMJ2777-000	X	0.15 to 0.30	8	4	550 to 650	high	491-011
DMF2344-000	Ku	0.05 to 0.15	13	2	260 to 330	low	491-011
DME2333-000	Ku	0.05 to 0.15	13	3	350 to 450	medium	491-011
DMJ2824-000	Ku	0.05 to 0.15	13	4	500 to 680	high	491-011
DMF2822-000	K, Ka	0.1 max	18	2	270 to 350	low	491-011
DME2458-000	K, Ka	0.1 max	18	3	375 to 550	medium	491-011
DMJ2825-000	K, Ka	0.1 max	18	4	600 to 700	high	491-011

Table 4. Electrical Specifications: Beam-Lead Series Pair, N-Type Low, Medium, High Drive Schottky Diodes

Part Number	Frequency Band	C _J @ 0 V, 1 MHz (pF)	Rs @ 5 mA (Ω)	V _B @ 10 μA (V)	V _F @ 1 mA (mV)	Drive Level	Outline Drawing
			Max.	Min.			
DMF2835-000	S, C	0.30 to 0.50	5	2	200 to 260	low	504-012
DME2050-000	S, C	0.30 to 0.50	5	3	300 to 400	medium	504-012
DMJ2092-000	S, C	0.30 to 0.50	5	4	500 to 600	high	504-012
DMF2826-000	X	0.15 to 0.30	8	2	220 to 300	low	504-012
DME2829-000	X	0.15 to 0.30	8	3	325 to 425	medium	504-012
DMJ2093-000	X	0.15 to 0.30	8	4	550 to 650	high	504-012
DMF2827-000	Ku	0.05 to 0.15	13	2	260 to 330	low	504-012
DME2830-000	Ku	0.05 to 0.15	13	3	350 to 450	medium	504-012
DMJ2832-000	Ku	0.05 to 0.15	13	4	500 to 680	high	504-012
DMF2828-000	K, Ka	0.1 max	18	2	270 to 350	low	504-012
DME2831-000	K, Ka	0.1 max	18	3	375 to 550	medium	504-012
DMJ2833-000	K, Ka	0.1 max	18	4	600 to 700	high	504-012

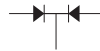
Table 5. Electrical Specifications: Beam-Lead Common Cathode, N-Type Low, Medium, High Drive Schottky Diodes

Part Number	Frequency Band	C _J @ 0 V, 1 MHz (pF)	Rs @ 5 mA (Ω)	V _B @ 10 μA (V)	V _F @ 1 mA (mV)	Drive Level	Outline Drawing
			Max.	Min.			
DMF2182-000	S, C	0.30 to 0.50	5	2	200 to 260	low	504-013
DME2205-000	S, C	0.30 to 0.50	5	3	300 to 400	medium	504-013
DMJ2208-000	S, C	0.30 to 0.50	5	4	500 to 600	high	504-013
DMF2183-000	X	0.15 to 0.30	8	2	220 to 300	low	504-013
DME2206-000	X	0.15 to 0.30	8	3	325 to 425	medium	504-013
DMJ2209-000	X	0.15 to 0.30	8	4	550 to 650	high	504-013
DMF2184-000	Ku	0.05 to 0.15	13	2	260 to 330	low	504-013
DME2207-000	Ku	0.05 to 0.15	13	3	350 to 450	medium	504-013
DMJ2210-000	Ku	0.05 to 0.15	13	4	500 to 680	high	504-013
DMF2834-000	K, Ka	0.1 max	18	2	270 to 350	low	504-013
DME2864-000	K, Ka	0.1 max	18	3	375 to 550	medium	504-013
DMJ2836-000	K, Ka	0.1 max	18	4	600 to 700	high	504-013

Table 6. Electrical Specifications: Beam-Lead Anti-Parallel, N-Type Low, Medium, High Drive Schottky Diodes



Part Number	Frequency Band	C _J @ 0 V, 1 MHz (pF)	Rs @ 5 mA (Ω)	V _B @ 10 μA (V)	V _F @ 1 mA (mV)	Drive Level	Outline Drawing
			Max.	Min.			
DMF2185-000	S, C	0.30 to 0.50	5	2	200 to 260	low	522-025
DME2282-000	S, C	0.30 to 0.50	5	3	300 to 400	medium	522-025
DMJ2303-000	S, C	0.30 to 0.50	5	4	500 to 600	high	522-025
DMF2186-000	X	0.15 to 0.30	8	2	220 to 300	low	522-025
DME2283-000	X	0.15 to 0.30	8	3	325 to 425	medium	522-025
DMJ2304-000	X	0.15 to 0.30	8	4	550 to 650	high	522-025
DMF2187-000	Ku	0.05 to 0.15	13	2	260 to 330	low	522-025
DME2284-000	Ku	0.05 to 0.15	13	3	350 to 450	medium	522-025
DMJ2246-000	Ku	0.05 to 0.15	13	4	500 to 680	high	522-025
DMF2837-000	K, Ka	0.1 max	18	2	270 to 350	low	522-025
DME2838-000	K, Ka	0.1 max	18	3	375 to 550	medium	522-025
DMJ2839-000	K, Ka	0.1 max	18	4	600 to 700	high	522-025

Table 7. Electrical Specifications: Beam-Lead Ring Quad, N-Type Low, Medium, High Drive Schottky Diodes



Part Number	Frequency Band	C _J @ 0 V, 1 MHz (pF)	Rs @ 5 mA (Ω)	V _B @ 10 μA (V)	V _F @ 1 mA (mV)	Drive Level	Outline Drawing
			Max.	Min.			
DMF2865-000	S, C	0.30 to 0.50	5	2	200 to 260	low	488-002
DME2857-000	S, C	0.30 to 0.50	5	3	300 to 400	medium	488-002
DMJ2502-000	S, C	0.30 to 0.50	5	4	500 to 600	high	488-002
DMF2011-000	X	0.15 to 0.30	8	2	220 to 300	low	488-002
DME2858-000	X	0.15 to 0.30	8	3	325 to 425	medium	488-002
DMJ2990-000	X	0.15 to 0.30	8	4	550 to 650	high	488-002
DMF2012-000	Ku	0.05 to 0.15	13	2	260 to 330	low	488-002
DME2859-000	Ku	0.05 to 0.15	13	3	350 to 450	medium	488-002
DMJ2667-000	Ku	0.05 to 0.15	13	4	500 to 680	high	488-002
DMF2454-000	K, Ka	0.1 max	18	2	270 to 350	low	488-002
DME2459-000	K, Ka	0.1 max	18	3	375 to 550	medium	488-002
DMJ2455-000	K, Ka	0.1 max	18	4	600 to 700	high	488-002

Table 8. Electrical Specifications: Beam-Lead Bridge Quad, N-Type Low, Medium, High Drive Schottky Diodes



Part Number	Frequency Band	C _J @ 0 V, 1 MHz (pF)	Rs @ 5 mA (Ω)	V _B @ 10 μA (V)	V _F @ 1 mA (mV)	Drive Level	Outline Drawing
			Max.	Min.			
DMF2076-000	S, C	0.30 to 0.50	5	2	200 to 260	low	488-004
DME2029-000	S, C	0.30 to 0.50	5	3	300 to 400	medium	488-004
DMJ2312-000	S, C	0.30 to 0.50	5	4	500 to 600	high	488-004
DMF2077-000	X	0.15 to 0.30	8	2	220 to 300	low	488-004
DME2850-000	X	0.15 to 0.30	8	3	325 to 425	medium	488-004
DMJ2088-000	X	0.15 to 0.30	8	4	550 to 650	high	488-004
DMF2078-000	Ku	0.05 to 0.15	13	2	260 to 330	low	488-004
DME2031-000	Ku	0.05 to 0.15	13	3	350 to 450	medium	488-004
DMJ2768-000	Ku	0.05 to 0.15	13	4	500 to 680	high	488-004
DMF2848-000	K, Ka	0.1 max	18	2	270 to 350	low	488-004
DME2851-000	K, Ka	0.1 max	18	3	375 to 550	medium	488-004
DMJ2852-000	K, Ka	0.1 max	18	4	600 to 700	high	488-004

Typical Performance Characteristics

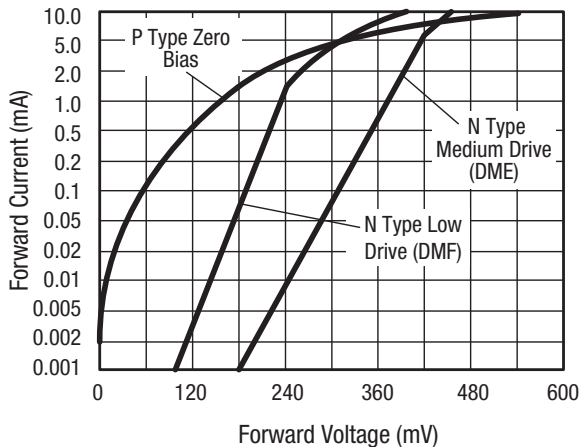

Figure 1. Typical Forward DC Characteristic Curves (Voltage vs Current)

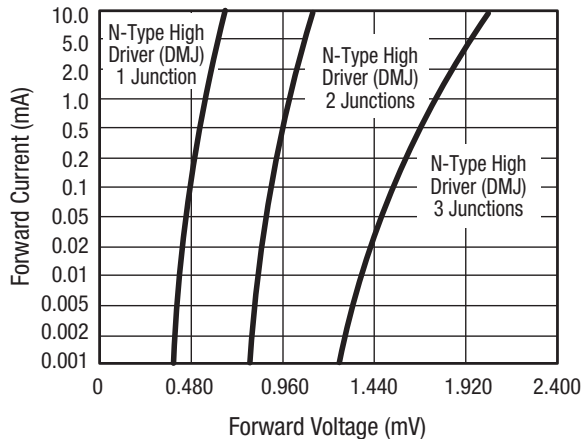

Figure 2. Typical Forward DC Characteristic Curves (Voltage vs current)

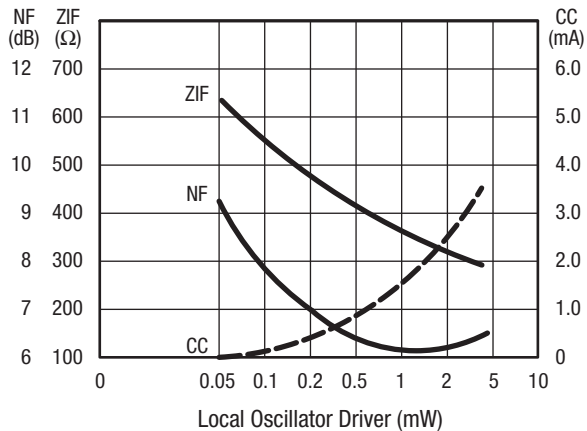
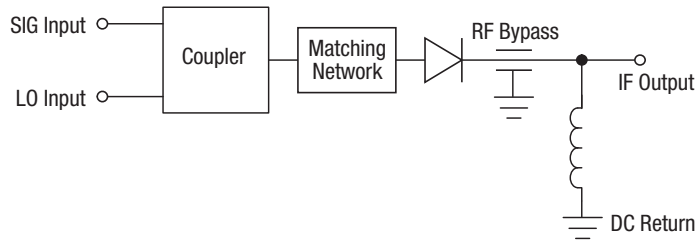
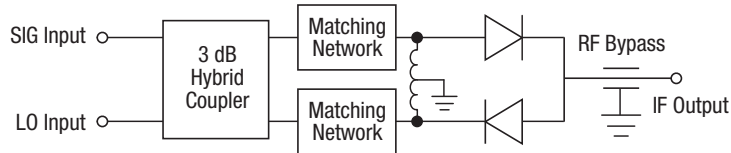

Figure 3. Typical X-Band Low Drive Mixer Diode RF Parameters vs Local Oscillator Drive

Single Ended Mixer



Balanced Mixer



Double Balanced Mixer

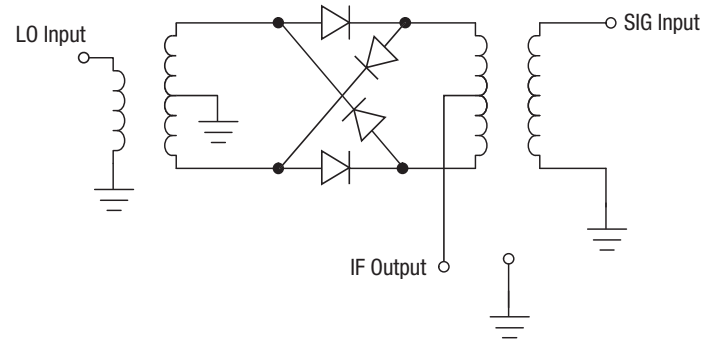

Figure 4. Typical Mixer Circuits

Dimensions and Package Information

Additional bonding and handling methods are contained in the Skyworks Application Note, *Diode Chips, Beam-Lead Diodes, Capacitors: Bonding Methods and Packaging* (document #200532).

Dimensions are provided in Figures 5 through 10.

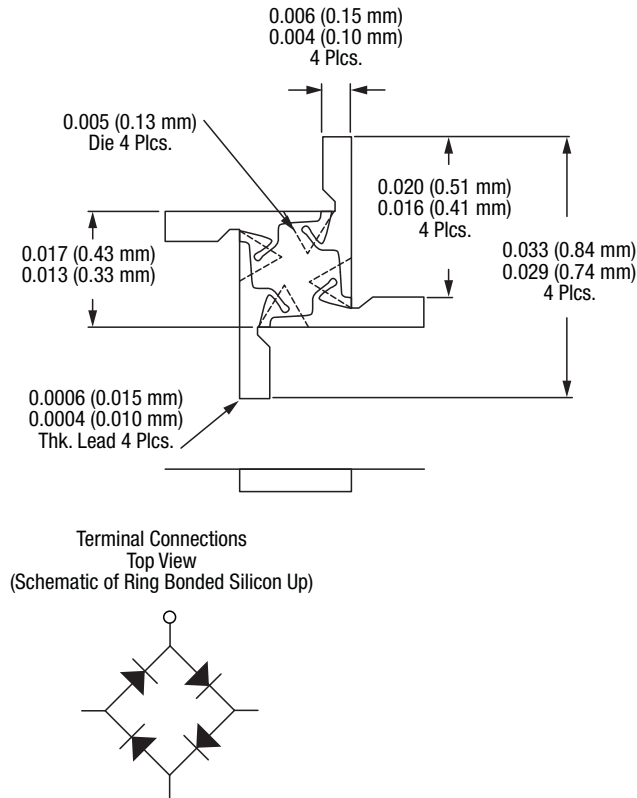

Figure 5. 488-002 Package Dimensions

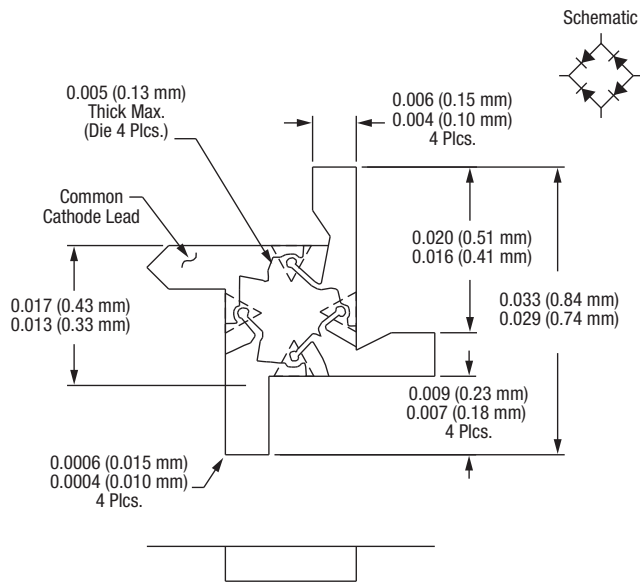

Figure 6. 488-004 Package Dimensions

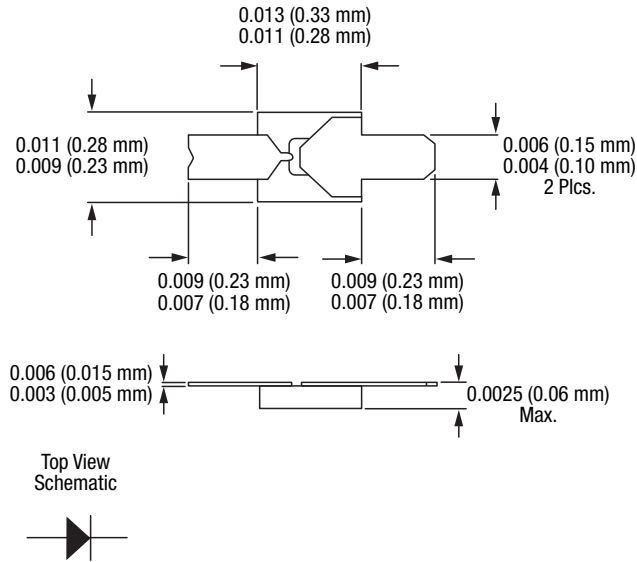

Figure 7. 491-011 Package Dimensions

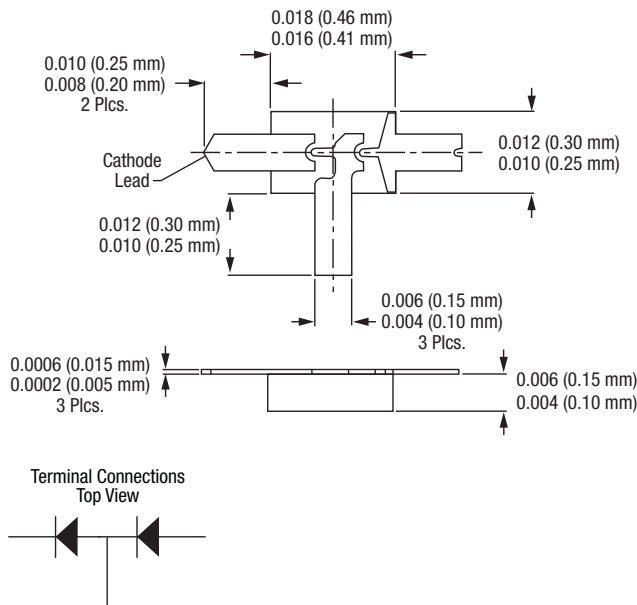

Figure 8. 504-012 Package Dimensions

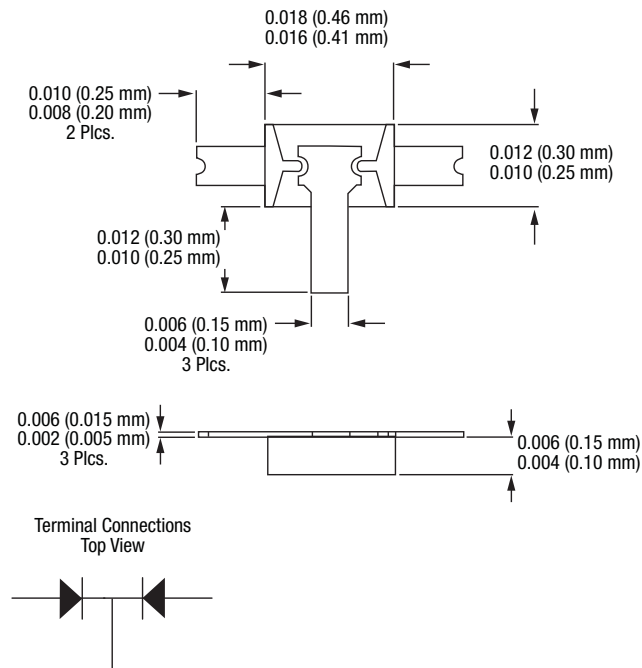

Figure 9. 504-013 Package Dimensions

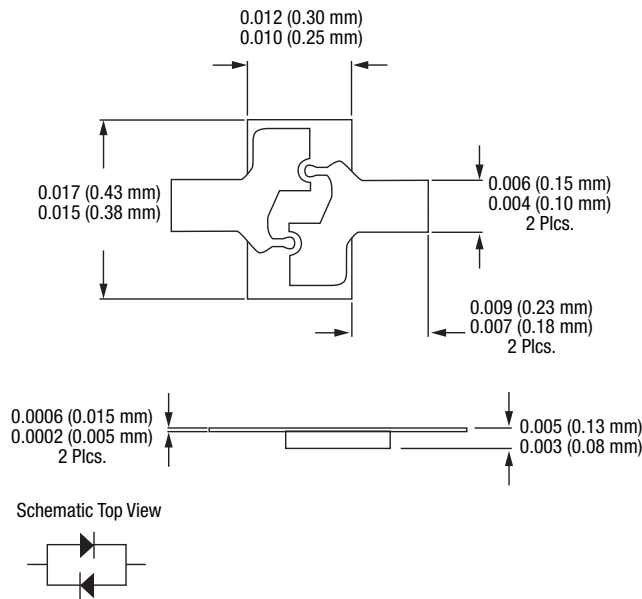

Figure 10. 522-025 Package Dimensions

Copyright © 2002-2009, 2014 Skyworks Solutions, Inc. All Rights Reserved.

Information in this document is provided in connection with Skyworks Solutions, Inc. ("Skyworks") products or services. These materials, including the information contained herein, are provided by Skyworks as a service to its customers and may be used for informational purposes only by the customer. Skyworks assumes no responsibility for errors or omissions in these materials or the information contained herein. Skyworks may change its documentation, products, services, specifications or product descriptions at any time, without notice. Skyworks makes no commitment to update the materials or information and shall have no responsibility whatsoever for conflicts, incompatibilities, or other difficulties arising from any future changes.

No license, whether express, implied, by estoppel or otherwise, is granted to any intellectual property rights by this document. Skyworks assumes no liability for any materials, products or information provided hereunder, including the sale, distribution, reproduction or use of Skyworks products, information or materials, except as may be provided in Skyworks Terms and Conditions of Sale.

THE MATERIALS, PRODUCTS AND INFORMATION ARE PROVIDED "AS IS" WITHOUT WARRANTY OF ANY KIND, WHETHER EXPRESS, IMPLIED, STATUTORY, OR OTHERWISE, INCLUDING FITNESS FOR A PARTICULAR PURPOSE OR USE, MERCHANTABILITY, PERFORMANCE, QUALITY OR NON-INFRINGEMENT OF ANY INTELLECTUAL PROPERTY RIGHT; ALL SUCH WARRANTIES ARE HEREBY EXPRESSLY DISCLAIMED. SKYWORKS DOES NOT WARRANT THE ACCURACY OR COMPLETENESS OF THE INFORMATION, TEXT, GRAPHICS OR OTHER ITEMS CONTAINED WITHIN THESE MATERIALS. SKYWORKS SHALL NOT BE LIABLE FOR ANY DAMAGES, INCLUDING BUT NOT LIMITED TO ANY SPECIAL, INDIRECT, INCIDENTAL, STATUTORY, OR CONSEQUENTIAL DAMAGES, INCLUDING WITHOUT LIMITATION, LOST REVENUES OR LOST PROFITS THAT MAY RESULT FROM THE USE OF THE MATERIALS OR INFORMATION, WHETHER OR NOT THE RECIPIENT OF MATERIALS HAS BEEN ADVISED OF THE POSSIBILITY OF SUCH DAMAGE.

Skyworks products are not intended for use in medical, lifesaving or life-sustaining applications, or other equipment in which the failure of the Skyworks products could lead to personal injury, death, physical or environmental damage. Skyworks customers using or selling Skyworks products for use in such applications do so at their own risk and agree to fully indemnify Skyworks for any damages resulting from such improper use or sale.

Customers are responsible for their products and applications using Skyworks products, which may deviate from published specifications as a result of design defects, errors, or operation of products outside of published parameters or design specifications. Customers should include design and operating safeguards to minimize these and other risks. Skyworks assumes no liability for applications assistance, customer product design, or damage to any equipment resulting from the use of Skyworks products outside of stated published specifications or parameters.

Skyworks and the Skyworks symbol are trademarks or registered trademarks of Skyworks Solutions, Inc., in the United States and other countries. Third-party brands and names are for identification purposes only, and are the property of their respective owners. Additional information, including relevant terms and conditions, posted at www.skyworksinc.com, are incorporated by reference.