



Chipsmall Limited consists of a professional team with an average of over 10 year of expertise in the distribution of electronic components. Based in Hongkong, we have already established firm and mutual-benefit business relationships with customers from,Europe,America and south Asia,supplying obsolete and hard-to-find components to meet their specific needs.

With the principle of “Quality Parts,Customers Priority,Honest Operation,and Considerate Service”,our business mainly focus on the distribution of electronic components. Line cards we deal with include Microchip,ALPS,ROHM,Xilinx,Pulse,ON,Everlight and Freescale. Main products comprise IC,Modules,Potentiometer,IC Socket,Relay,Connector.Our parts cover such applications as commercial,industrial, and automotives areas.

We are looking forward to setting up business relationship with you and hope to provide you with the best service and solution. Let us make a better world for our industry!



## Contact us

Tel: +86-755-8981 8866 Fax: +86-755-8427 6832

Email & Skype: info@chipsmall.com Web: www.chipsmall.com

Address: A1208, Overseas Decoration Building, #122 Zhenhua RD., Futian, Shenzhen, China



## Description and Applications

The DML3006LFDS load switch provides a component and area-reducing solution for efficient power domain switching with inrush current limit via soft-start. In addition to integrated control functionality with ultra low on-resistance, this device offers system safeguards and monitoring via fault protection and power good signaling. This cost effective solution is ideal for power management and hot-swap applications requiring low power consumption in a small footprint.

- Portable Electronics and Systems
- Notebook and Tablet Computers
- Telecom, Networking, Medical, and Industrial Equipment
- Set-Top Boxes, Servers, and Gateways
- Hot-Swap Devices and Peripheral Ports

## Features and Benefits

- Advanced Controller with ChargePump
- Integrated N-Channel MOSFET with Ultra Low  $R_{ON}$
- Input Voltage Range 0.5V to 13.5V
- Soft-Start via Controlled SlewRate
- Power Good Signal
- Thermal Shutdown
- $V_{IN}$  Under-Voltage Lockout
- Short-Circuit Protection
- Extremely Low Standby Current
- Load Bleed (Quick Discharge)
- **Totally Lead-Free & Fully RoHS Compliant (Notes 1 & 2)**
- **Halogen and Antimony Free. "Green" Device (Note 3)**

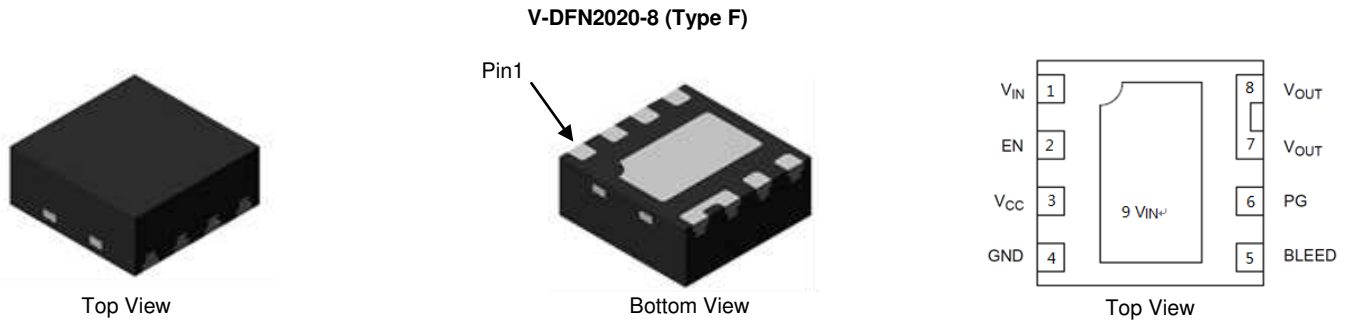

## Ordering Information (Note 4)

Part Number	Case	Packaging
DML3006LFDS-7	V-DFN2020-8 (Type F)	3,000/Tape & Reel

- Notes:
1. No purposely added lead. Fully EU Directive 2002/95/EC (RoHS), 2011/65/EU (RoHS 2) & 2015/863/EU (RoHS 3) compliant.
  2. See <https://www.diodes.com/quality/lead-free/> for more information about Diodes Incorporated's definitions of Halogen- and Antimony-free, "Green" and Lead-free.
  3. Halogen- and Antimony-free "Green" products are defined as those which contain <900ppm bromine, <900ppm chlorine (<1500ppm total Br + Cl) and <1000ppm antimony compounds.
  4. For packaging details, go to our website at <https://www.diodes.com/design/support/packaging/diodes-packaging/>.

## Pin Description

Pin Number	Pin Name	Pin Function
1, 9	$V_{IN}$	Drain of MOSFET (0.5V to 13.5V), Pin 1 must be connected to Pin 9
2	EN	Active-high digital input used to turn on the MOSFET, pin has an internal pull down resistor to GND
3	$V_{CC}$	Supply voltage to controller (3.0V to 5.5V)
4	GND	Controller ground
5	BLEED	Load bleed connection, must be tied to $V_{OUT}$ through a resistor $\leq 1k\Omega$
6	PG	Active-high, open-drain output that indicates when the gate of the MOSFET is fully charged, external pull up resistor $\geq 1k\Omega$ to an external voltage source required; tie to GND if not used.
7, 8	$V_{OUT}$	Source of MOSFET connected to load

**Marking Information**

V-DFN2020-8 (Type F)

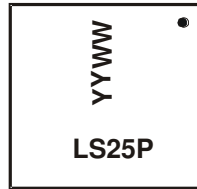

LS25P = Product Type Marking Code  
 YYWW = Date Code Marking  
 YY = Last Two Digits of Year (ex: 18 = 2018)  
 WW = Week Code (01 to 53)

**Functional Block Diagram**

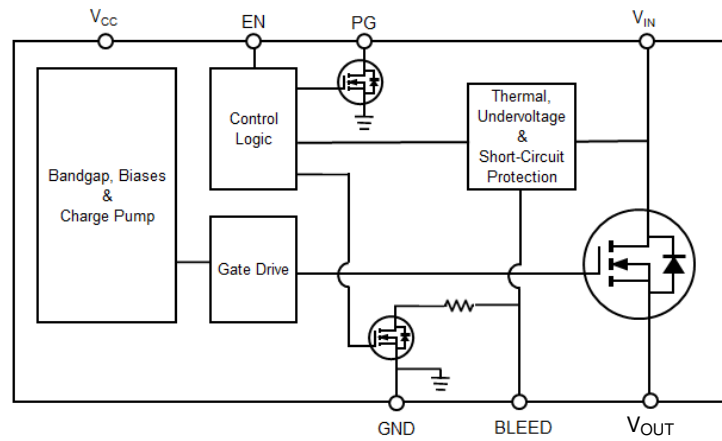

**Application Circuit**

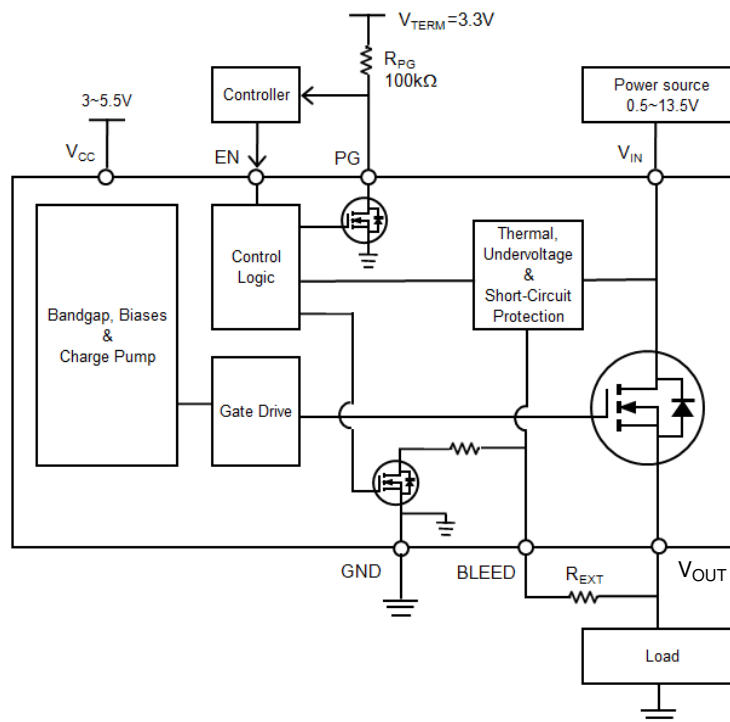

NEW PRODUCT

**Absolute Maximum Ratings**

Parameter	Rating
V <sub>IN</sub> , BLEED, V <sub>OUT</sub> to GND	-0.3V to 18V
EN, V <sub>CC</sub> , PG to GND	-0.3V to 6V
I <sub>MAX</sub>	10.5A
Junction Temperature (T <sub>J</sub> )	+150°C
Storage Temperature (T <sub>S</sub> )	-65°C to +150°C

**Recommended Operating Ratings**

Parameter	Rating
Supply Voltage (V <sub>CC</sub> )	3V to 5.5V
Input Voltage (V <sub>IN</sub> )	0.5V to 13.5V
Ambient Temperature (T <sub>A</sub> )	-40°C to +85°C
Package Thermal Resistance (θ <sub>JC</sub> )	5.3°C/W
Package Thermal Resistance (θ <sub>JA</sub> )	40°C/W

**Electrical Characteristics** (T<sub>J</sub> = +25°C, unless otherwise specified.)

Symbol	Parameter	Conditions	Min	Typ	Max	Unit
V <sub>IN</sub>	Input Voltage	—	0.5	—	13.5	V
V <sub>CC</sub>	Supply Voltage	—	3.0	—	5.5	V
I <sub>DYN</sub>	V <sub>CC</sub> Dynamic Supply Current	V <sub>EN</sub> = V <sub>CC</sub> = 3V, V <sub>IN</sub> = 12V	—	310	400	μA
		V <sub>EN</sub> = V <sub>CC</sub> = 5.5V, V <sub>IN</sub> = 1.8V	—	510	750	μA
I <sub>STBY</sub>	V <sub>CC</sub> Shutdown Supply Current	V <sub>CC</sub> = 3V, V <sub>EN</sub> = 0V	—	0.1	1	μA
		V <sub>CC</sub> = 5.5V, V <sub>EN</sub> = 0V	—	0.1	2	μA
V <sub>ENH</sub>	EN High Level Voltage	V <sub>CC</sub> = 3V to 5.5V	2.0	—	—	V
V <sub>ENL</sub>	EN Low Level Voltage	V <sub>CC</sub> = 3V to 5.5V	—	—	0.8	V
R <sub>BLEED</sub>	Bleed Resistance	V <sub>CC</sub> = 3V, V <sub>EN</sub> = 0V	86	108	130	Ω
		V <sub>CC</sub> = 5.5V, V <sub>EN</sub> = 0V	64	80	100	Ω
I <sub>BLEED</sub>	Bleed Pin Leakage Current	V <sub>CC</sub> = V <sub>EN</sub> = 3V, V <sub>IN</sub> = 1.8V	—	20	45	μA
		V <sub>CC</sub> = V <sub>EN</sub> = 3V, V <sub>IN</sub> = 12V	—	50	70	μA
V <sub>PGL</sub>	PG Output Low Voltage	V <sub>CC</sub> = 3V; I <sub>SINK</sub> = 5mA	—	—	0.2	V
I <sub>PG</sub>	PG Output Leakage Current	V <sub>CC</sub> = 3V; V <sub>TERM</sub> = 3.3V	—	—	100	nA
<b>Switching Device</b>						
R <sub>ON</sub>	Switch On-State Resistance	V <sub>CC</sub> = 3.3V, V <sub>IN</sub> = 1.8V	—	10.8	12.5	mΩ
		V <sub>CC</sub> = 3.3V, V <sub>IN</sub> = 5V	—	10.8	12.5	mΩ
		V <sub>CC</sub> = 3.3V, V <sub>IN</sub> = 12V	—	10.8	12.5	mΩ
		V <sub>CC</sub> = 5V, V <sub>IN</sub> = 1.8V	—	8.6	10.5	mΩ
		V <sub>CC</sub> = 5V, V <sub>IN</sub> = 5V	—	8.6	10.5	mΩ
		V <sub>CC</sub> = 5V, V <sub>IN</sub> = 12V	—	8.6	10.5	mΩ
I <sub>LEAK</sub>	Input Shutdown Supply Current	V <sub>EN</sub> = 0V, V <sub>IN</sub> = 13.5V	—	—	1	μA
R <sub>PDEN</sub>	EN Pull Down Resistance	—	76	100	124	kΩ
<b>Fault Protection</b>						
OTP	Thermal Shutdown Threshold	V <sub>CC</sub> = 3V to 5.5V	—	145	—	°C
OTPHYS	Thermal Shutdown Hysteresis	V <sub>CC</sub> = 3V to 5.5V	—	20	—	°C
UVLO	V <sub>IN</sub> Lockout Threshold	V <sub>CC</sub> = 3V	0.25	0.35	0.45	V
UVLOHYS	V <sub>IN</sub> Lockout Hysteresis	V <sub>CC</sub> = 3V	20	40	70	mV
SCP	Short-Circuit Protection Threshold	V <sub>CC</sub> = 3.3V; V <sub>IN</sub> = 0.5V	180	265	350	mV
		V <sub>CC</sub> = 3.3V; V <sub>IN</sub> = 13.5V	100	285	500	mV

**Switching Characteristics** ( $T_J = +25^\circ\text{C}$ ,  $V_{\text{TERM}} = V_{\text{CC}}$ ;  $R_{\text{PG}} = 100\text{k}\Omega$ ;  $R_L = 10\Omega$ ;  $C_L = 0.1\mu\text{F}$ , unless otherwise specified).

Symbol	Parameter	Condition	Min	Typ	Max	Unit
<b><math>V_{\text{IN}} = 1.8\text{V}</math></b>						
$t_{\text{ON}}$	Output Turn-On Delay time	$V_{\text{CC}}=3.3\text{V}$	—	200	—	$\mu\text{s}$
		$V_{\text{CC}}=5\text{V}$	—	190	—	
$t_{\text{OFF}}$	Output Turn-Off Delay time	$V_{\text{CC}}=3.3\text{V}$	—	0.4	—	$\mu\text{s}$
		$V_{\text{CC}}=5\text{V}$	—	0.4	—	
$t_{\text{PGON}}$	Power Good Turn-on Time	$V_{\text{CC}}=3.3\text{V}$	—	1.25	—	ms
		$V_{\text{CC}}=5\text{V}$	—	1.05	—	
$t_{\text{PGOFF}}$	Power Good Turn-off Time	$V_{\text{CC}}=3.3\text{V}$	—	10	—	ns
		$V_{\text{CC}}=5\text{V}$	—	8	—	
SR	Output Slew Rate	$V_{\text{CC}}=3.3\text{V}$	—	23	—	kV/s
		$V_{\text{CC}}=5\text{V}$	—	24	—	
<b><math>V_{\text{IN}} = 12\text{V}</math></b>						
$t_{\text{ON}}$	Output Turn-On Delay time	$V_{\text{CC}}=3.3\text{V}$	—	190	—	$\mu\text{s}$
		$V_{\text{CC}}=5\text{V}$	—	180	—	
$t_{\text{OFF}}$	Output Turn-Off Delay time	$V_{\text{CC}}=3.3\text{V}$	—	0.4	—	$\mu\text{s}$
		$V_{\text{CC}}=5\text{V}$	—	0.4	—	
$t_{\text{PGON}}$	Power Good Turn-on Time	$V_{\text{CC}}=3.3\text{V}$	—	1.3	—	ms
		$V_{\text{CC}}=5\text{V}$	—	1.25	—	
$t_{\text{PGOFF}}$	Power Good Turn-off Time	$V_{\text{CC}}=3.3\text{V}$	—	10	—	ns
		$V_{\text{CC}}=5\text{V}$	—	8	—	
SR	Output Slew Rate	$V_{\text{CC}}=3.3\text{V}$	—	80	—	kV/s
		$V_{\text{CC}}=5\text{V}$	—	81	—	

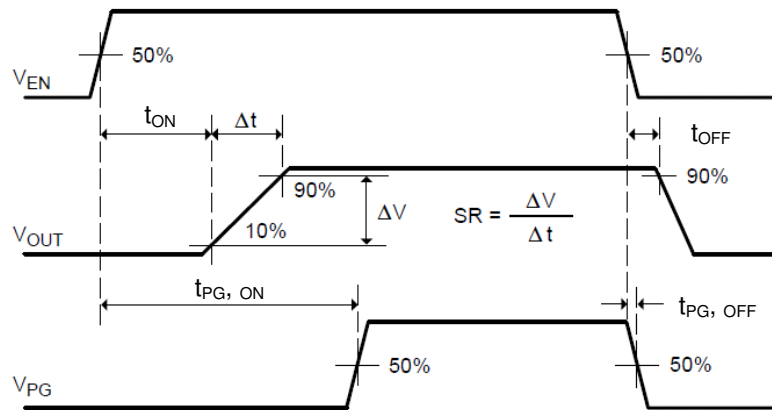
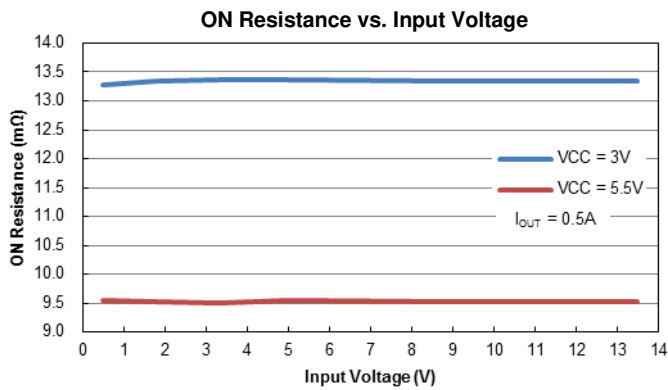
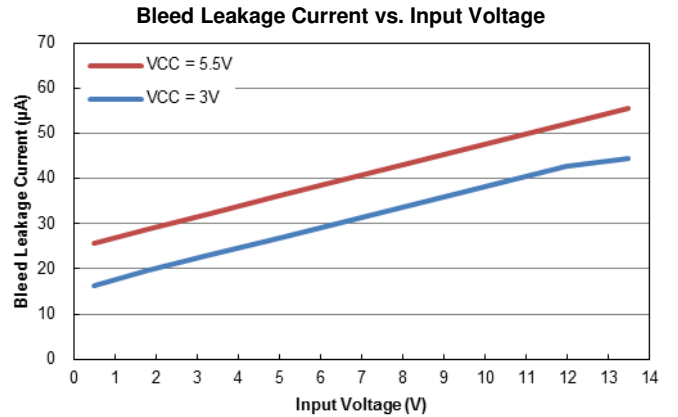
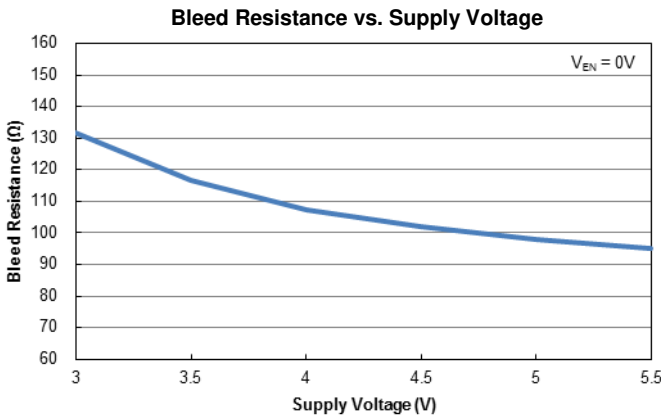
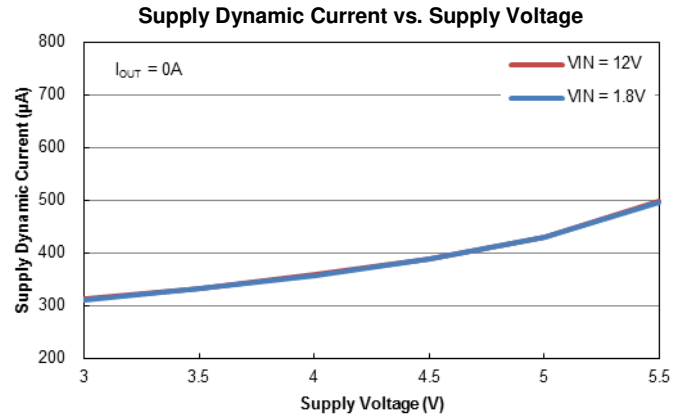
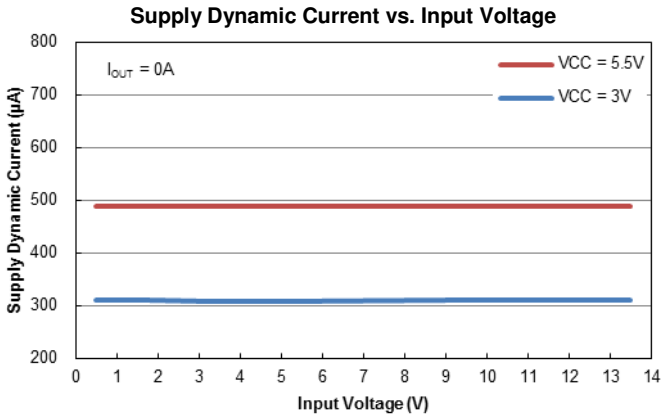

Figure 1 Timing Diagram

NEW PRODUCT

**Performance Characteristics** (@T<sub>A</sub> = +25°C, unless otherwise specified.)

NEW PRODUCT



**Performance Characteristics** (@ $T_A = +25^\circ\text{C}$ , unless otherwise specified. Cont.)

NEW PRODUCT

**Turn ON Response**

$V_{IN} = 1.8\text{V}$ ,  $V_{CC} = 3.3\text{V}$ ,  $V_{EN} = 0\text{V to } 3.3\text{V}$ ,  $R_L = 10\Omega$

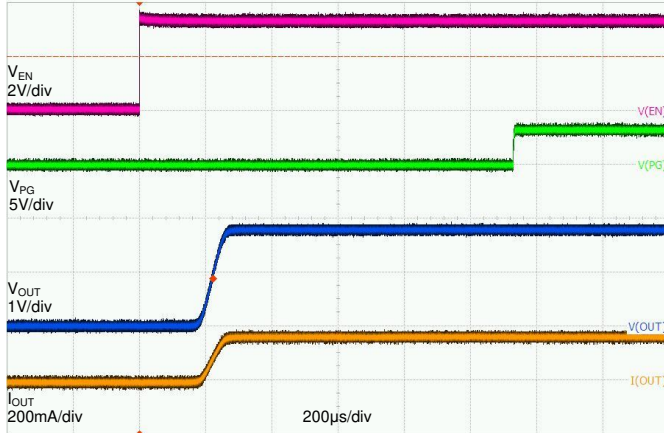

**Turn OFF Response**

$V_{IN} = 1.8\text{V}$ ,  $V_{CC} = 3.3\text{V}$ ,  $V_{EN} = 3.3\text{V to } 0\text{V}$ ,  $R_L = 10\Omega$

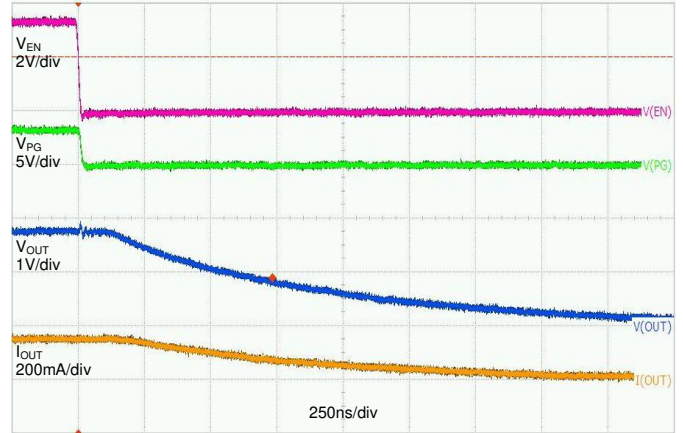

**Turn ON Response**

$V_{IN} = 5.0\text{V}$ ,  $V_{CC} = 3.3\text{V}$ ,  $V_{EN} = 0\text{V to } 3.3\text{V}$ ,  $R_L = 10\Omega$

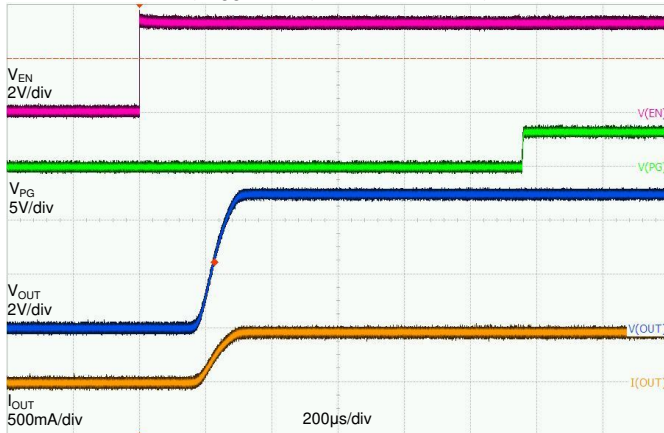

**Turn OFF Response**

$V_{IN} = 5.0\text{V}$ ,  $V_{CC} = 3.3\text{V}$ ,  $V_{EN} = 3.3\text{V to } 0\text{V}$ ,  $R_L = 10\Omega$

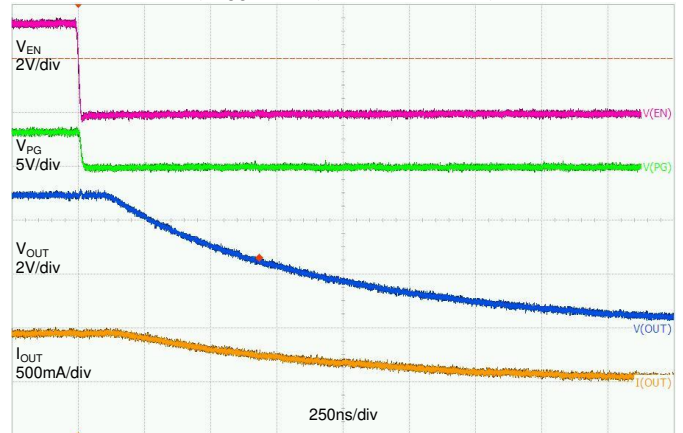

**Turn ON Response**

$V_{IN} = 12\text{V}$ ,  $V_{CC} = 3.3\text{V}$ ,  $V_{EN} = 0\text{V to } 3.3\text{V}$ ,  $R_L = 10\Omega$

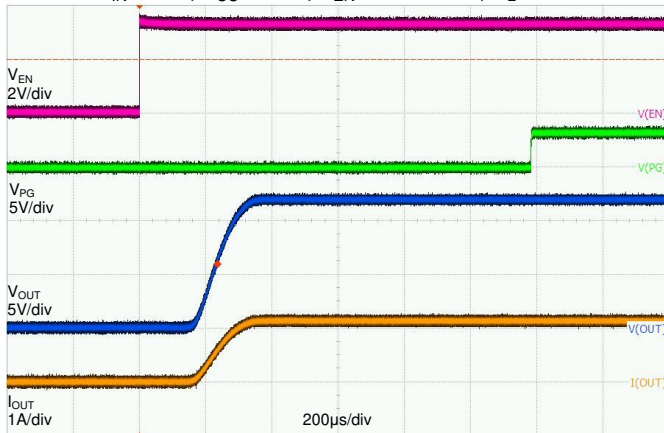

**Turn OFF Response**

$V_{IN} = 12\text{V}$ ,  $V_{CC} = 3.3\text{V}$ ,  $V_{EN} = 3.3\text{V to } 0\text{V}$ ,  $R_L = 10\Omega$

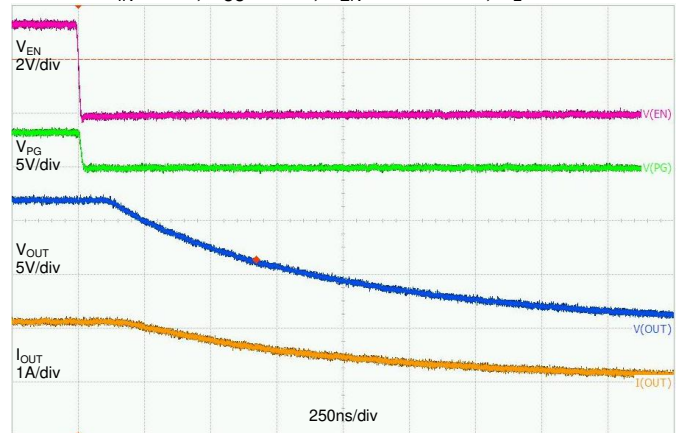

**Performance Characteristics** (@ $T_A = +25^\circ\text{C}$ , unless otherwise specified. Cont.)

NEW PRODUCT

**Turn ON Response**

$V_{IN} = 1.8\text{V}$ ,  $V_{CC} = 5.0\text{V}$ ,  $V_{EN} = 0\text{V}$  to  $3.3\text{V}$ ,  $R_L = 10\Omega$

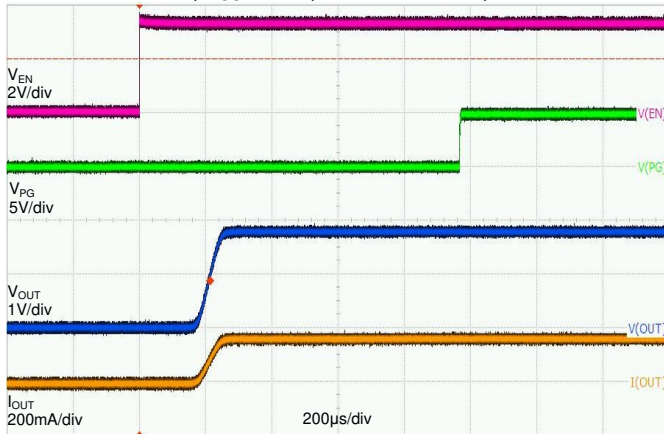

**Turn OFF Response**

$V_{IN} = 1.8\text{V}$ ,  $V_{CC} = 5.0\text{V}$ ,  $V_{EN} = 3.3\text{V}$  to  $0\text{V}$ ,  $R_L = 10\Omega$

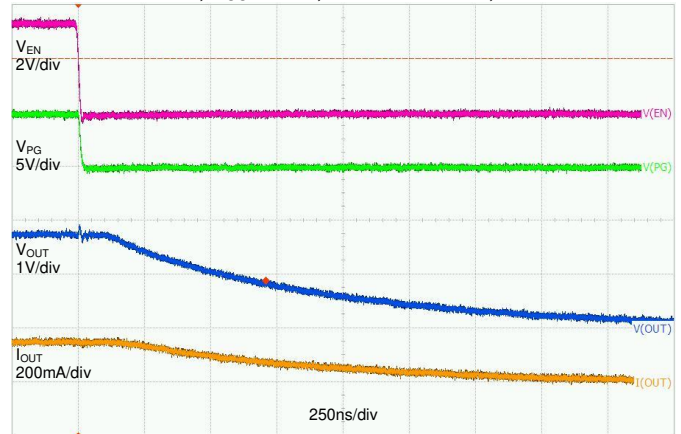

**Turn ON Response**

$V_{IN} = 5.0\text{V}$ ,  $V_{CC} = 5.0\text{V}$ ,  $V_{EN} = 0\text{V}$  to  $3.3\text{V}$ ,  $R_L = 10\Omega$

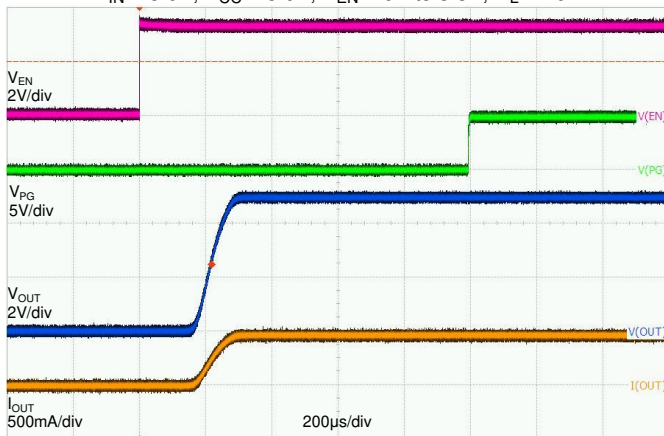

**Turn OFF Response**

$V_{IN} = 5.0\text{V}$ ,  $V_{CC} = 5.0\text{V}$ ,  $V_{EN} = 3.3\text{V}$  to  $0\text{V}$ ,  $R_L = 10\Omega$

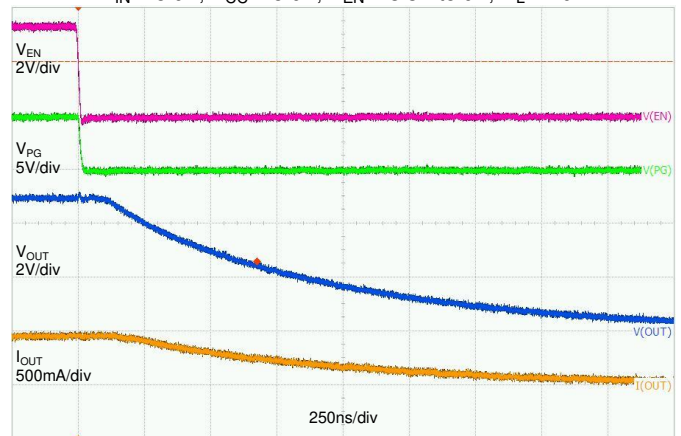

**Turn ON Response**

$V_{IN} = 12\text{V}$ ,  $V_{CC} = 5.0\text{V}$ ,  $V_{EN} = 0\text{V}$  to  $3.3\text{V}$ ,  $R_L = 10\Omega$

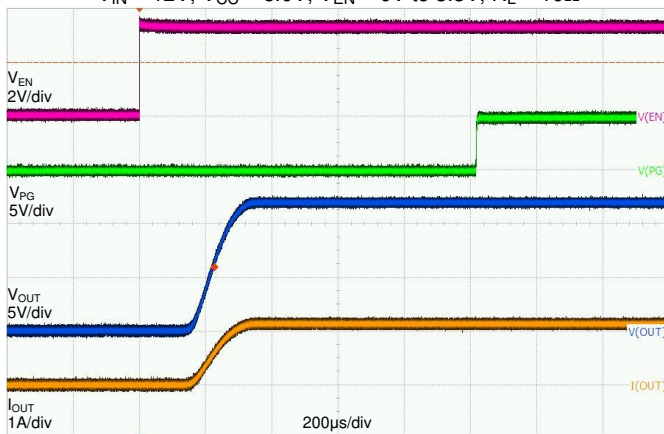

**Turn OFF Response**

$V_{IN} = 12\text{V}$ ,  $V_{CC} = 5.0\text{V}$ ,  $V_{EN} = 3.3\text{V}$  to  $0\text{V}$ ,  $R_L = 10\Omega$

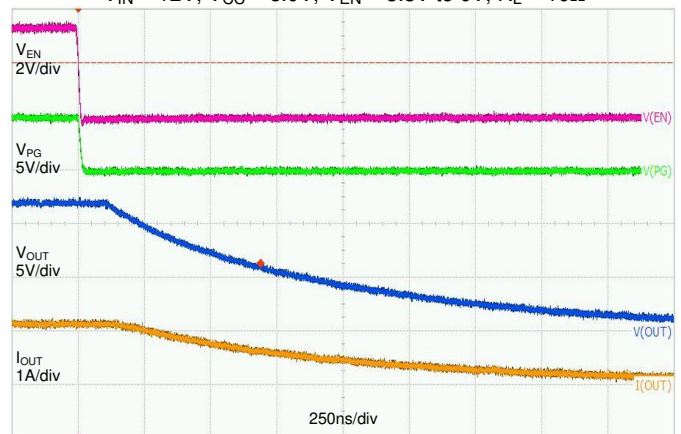



**Package Outline Dimensions**

Please see <http://www.diodes.com/package-outlines.html> for the latest version.

V-DFN2020-8 (Type F)

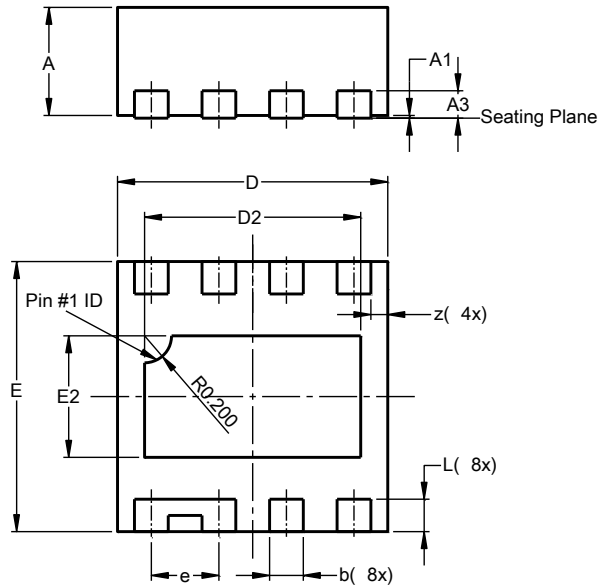

V-DFN2020-8 (Type F)			
Dim	Min	Max	Typ
A	0.77	0.85	0.80
A1	0.00	0.05	0.02
A3	--	--	0.203
b	0.20	0.30	0.25
D	1.95	2.05	2.00
D2	1.50	1.70	1.60
E	1.95	2.05	2.00
E2	0.80	1.00	0.90
e	--	--	0.50
L	0.19	0.29	0.24
z	--	--	0.125
All Dimensions in mm			

NEW PRODUCT

**Suggested Pad Layout**

Please see <http://www.diodes.com/package-outlines.html> for the latest version.

V-DFN2020-8 (Type F)

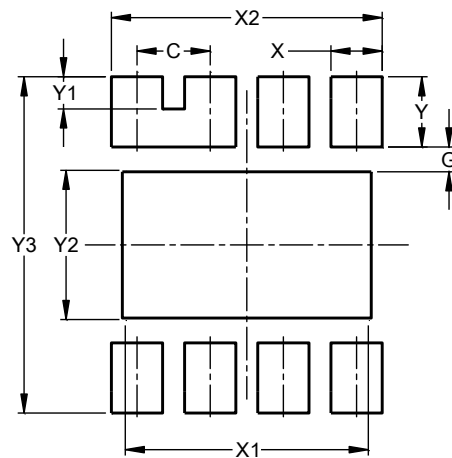

Dimensions	Value (in mm)
C	0.500
G	0.170
X	0.350
X1	1.660
X2	1.850
Y	0.480
Y1	0.220
Y2	1.020
Y3	2.300

**IMPORTANT NOTICE**

DIODES INCORPORATED MAKES NO WARRANTY OF ANY KIND, EXPRESS OR IMPLIED, WITH REGARDS TO THIS DOCUMENT, INCLUDING, BUT NOT LIMITED TO, THE IMPLIED WARRANTIES OF MERCHANTABILITY AND FITNESS FOR A PARTICULAR PURPOSE (AND THEIR EQUIVALENTS UNDER THE LAWS OF ANY JURISDICTION).

Diodes Incorporated and its subsidiaries reserve the right to make modifications, enhancements, improvements, corrections or other changes without further notice to this document and any product described herein. Diodes Incorporated does not assume any liability arising out of the application or use of this document or any product described herein; neither does Diodes Incorporated convey any license under its patent or trademark rights, nor the rights of others. Any Customer or user of this document or products described herein in such applications shall assume all risks of such use and will agree to hold Diodes Incorporated and all the companies whose products are represented on Diodes Incorporated website, harmless against all damages.

Diodes Incorporated does not warrant or accept any liability whatsoever in respect of any products purchased through unauthorized sales channel. Should Customers purchase or use Diodes Incorporated products for any unintended or unauthorized application, Customers shall indemnify and hold Diodes Incorporated and its representatives harmless against all claims, damages, expenses, and attorney fees arising out of, directly or indirectly, any claim of personal injury or death associated with such unintended or unauthorized application.

Products described herein may be covered by one or more United States, international or foreign patents pending. Product names and markings noted herein may also be covered by one or more United States, international or foreign trademarks.

This document is written in English but may be translated into multiple languages for reference. Only the English version of this document is the final and determinative format released by Diodes Incorporated.

**LIFE SUPPORT**

Diodes Incorporated products are specifically not authorized for use as critical components in life support devices or systems without the express written approval of the Chief Executive Officer of Diodes Incorporated. As used herein:

A. Life support devices or systems are devices or systems which:

1. are intended to implant into the body, or
2. support or sustain life and whose failure to perform when properly used in accordance with instructions for use provided in the labeling can be reasonably expected to result in significant injury to the user.

B. A critical component is any component in a life support device or system whose failure to perform can be reasonably expected to cause the failure of the life support device or to affect its safety or effectiveness.

Customers represent that they have all necessary expertise in the safety and regulatory ramifications of their life support devices or systems, and acknowledge and agree that they are solely responsible for all legal, regulatory and safety-related requirements concerning their products and any use of Diodes Incorporated products in such safety-critical, life support devices or systems, notwithstanding any devices- or systems-related information or support that may be provided by Diodes Incorporated. Further, Customers must fully indemnify Diodes Incorporated and its representatives against any damages arising out of the use of Diodes Incorporated products in such safety-critical, life support devices or systems.

Copyright © 2018, Diodes Incorporated

[www.diodes.com](http://www.diodes.com)