



Chipsmall Limited consists of a professional team with an average of over 10 year of expertise in the distribution of electronic components. Based in Hongkong, we have already established firm and mutual-benefit business relationships with customers from,Europe,America and south Asia,supplying obsolete and hard-to-find components to meet their specific needs.

With the principle of “Quality Parts,Customers Priority,Honest Operation,and Considerate Service”,our business mainly focus on the distribution of electronic components. Line cards we deal with include Microchip,ALPS,ROHM,Xilinx,Pulse,ON,Everlight and Freescale. Main products comprise IC,Modules,Potentiometer,IC Socket,Relay,Connector.Our parts cover such applications as commercial,industrial, and automotives areas.

We are looking forward to setting up business relationship with you and hope to provide you with the best service and solution. Let us make a better world for our industry!



Contact us

Tel: +86-755-8981 8866 Fax: +86-755-8427 6832

Email & Skype: info@chipsmall.com Web: www.chipsmall.com

Address: A1208, Overseas Decoration Building, #122 Zhenhua RD., Futian, Shenzhen, China



**30V SYNCHRONOUS N-CHANNEL ENHANCEMENT MODE MOSFET
PowerDI3333-8 (Type D)**
Product Summary

Device	BV _{DSS}	R _{DS(ON)} max
Q1	30V	12mΩ @ V _{GS} = 5V, I _D = 15A
Q2	30V	6mΩ @ V _{GS} = 5V, I _D = 15A

Description and Applications

This new generation MOSFET is designed to minimize the on-state resistance (R_{DS(ON)}) and yet maintain superior switching performance, making it ideal for high efficiency power management applications.

- DC-DC Converters
- Power Management Functions

Features and Benefits

- 100% Unclamped Inductive Switch (UIS) Test in Production
- Low On-Resistance
- Low Input Capacitance
- Fast Switching Speed
- **Lead-Free Finish; RoHS Compliant (Notes 1 & 2)**
- **Halogen and Antimony Free. "Green" Device (Note 3)**

Mechanical Data

- Case: PowerDI[®] 3333-8 (Type D)
- Case Material: Molded Plastic, "Green" Molding Compound. UL Flammability Classification Rating 94V-0
- Moisture Sensitivity: Level 1 per J-STD-020
- Terminal Connections: See Diagram
- Terminals: Finish – Matte Tin Annealed over Copper Leadframe. Solderable per MIL-STD-202, Method 208 (3)
- Weight: 0.044 grams (Approximate)

PowerDI3333-8 (Type D)

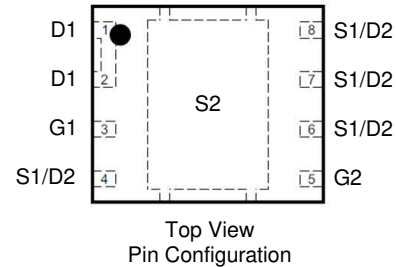
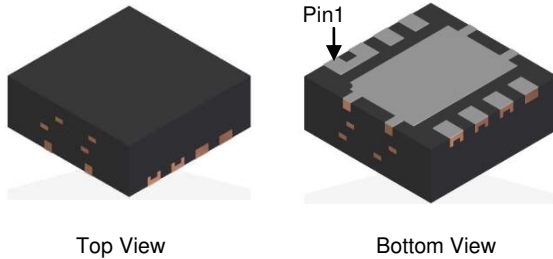
Ordering Information (Note 4)

Part Number	Case	Packaging
DMN3012LFG-7	PowerDI3333-8 (Type D)	1000 / Tape & Reel
DMN3012LFG-13	PowerDI3333-8 (Type D)	3000 / Tape & Reel

- Notes:
1. EU Directive 2002/95/EC (RoHS) & 2011/65/EU (RoHS 2) compliant. All applicable RoHS exemptions applied.
 2. See http://www.diodes.com/quality/lead_free.html for more information about Diodes Incorporated's definitions of Halogen- and Antimony-free, "Green" and Lead-free.
 3. Halogen- and Antimony-free "Green" products are defined as those which contain <900ppm bromine, <900ppm chlorine (<1500ppm total Br + Cl) and <1000ppm antimony compounds.
 4. For packaging details, go to our website at <https://www.diodes.com/design/support/packaging/diodes-packaging/>.

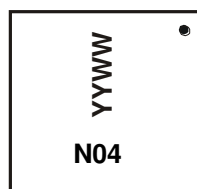
Marking Information

N04 = Product Type Marking Code
 YYWW = Date Code Marking
 YY = Last Two Digits of Year (ex: 17 = 2017)
 WW = Week Code (01 to 53)

Maximum Ratings (@T_A = +25°C, unless otherwise specified.)

Characteristic	Symbol	Q1	Q2	Unit
Drain-Source Voltage	V _{DSS}	30		V
Gate-Source Voltage	V _{GSS}	±10		V
Continuous Drain Current @ V _{GS} = 5V	T _C = +25°C T _C = +70°C	20 16		A
	T _A = +25°C T _A = +70°C	10 8		A
Pulsed Drain Current (10µs Pulse, Duty Cycle = 1%)	I _{DM}	70	100	A
Continuous Source-Drain Diode Current (Note 5)	I _S	2.7	3.2	A
Avalanche Current (Note 6) L = 0.1mH	I _{AS}	34	50	A
Avalanche Energy (Note 6) L = 0.1mH	E _{AS}	58	125	mJ

Thermal Characteristics (@T_A = +25°C, unless otherwise specified.)

Characteristic	Symbol	Value	Unit
Total Power Dissipation	P _D	T _C = +25°C	2.2
		T _C = +70°C	1.4
Thermal Resistance, Junction to Ambient (Note 5)	R _{θJA}	Steady State	58
		t < 10s	36
Thermal Resistance, Junction to Case (Note 5)	R _{θJC}	9.5	°C/W
Operating and Storage Temperature Range	T _J , T _{STG}	-55 to +150	°C

Electrical Characteristics Q1 (@T_A = +25°C, unless otherwise specified.)

Characteristic	Symbol	Min	Typ	Max	Unit	Test Condition
OFF CHARACTERISTICS (Note 7)						
Drain-Source Breakdown Voltage	BV _{DSS}	30	—	—	V	V _{GS} = 0V, I _D = 250µA
Zero Gate Voltage Drain Current	I _{DSS}	—	—	1	µA	V _{DS} = 20V, V _{GS} = 0V
Gate-Source Leakage	I _{GSS}	—	—	±100	nA	V _{GS} = ±10V, V _{DS} = 0V
ON CHARACTERISTICS (Note 7)						
Gate Threshold Voltage	V _{GS(TH)}	1	—	2.1	V	V _{DS} = V _{GS} , I _D = 250µA
Static Drain-Source On-Resistance	R _{DS(ON)}	—	10.5	12	mΩ	V _{GS} = 5V, I _D = 15A
Forward Transfer Admittance	Y _{fs}	—	27	—	S	V _{DS} = 5V, I _D = 15A
Diode Forward Voltage	V _{SD}	—	—	1.0	V	V _{GS} = 0V, I _S = 15A
DYNAMIC CHARACTERISTICS (Note 8)						
Input Capacitance	C _{iss}	—	650	850	pF	V _{DS} = 15V, V _{GS} = 0V, f = 1.0MHz
Output Capacitance	C _{oss}	—	314	410		
Reverse Transfer Capacitance	C _{rss}	—	12	16		
Gate Resistance	R _g	—	1.63	3.3	Ω	V _{DS} = 0V, V _{GS} = 0V, f = 1.0MHz
Total Gate Charge (V _{GS} = 4.5V)	Q _g	—	4.7	6.1	nC	V _{DS} = 15V, I _D = 15A
Total Gate Charge at V _{TH}	Q _{g(TH)}	—	0.91	—		
Gate-Source Charge	Q _{gs}	—	1.6	—		
Gate-Drain Charge	Q _{gd}	—	0.9	—		
Turn-On Delay Time	t _{D(ON)}	—	5.1	7.7	ns	V _{DD} = 15V, V _{GS} = 4.5V, I _D = 15A, R _G = 2Ω
Turn-On Rise Time	t _R	—	2.7	—		
Turn-Off Delay Time	t _{D(OFF)}	—	6.4	9.6		
Turn-Off Fall Time	t _F	—	2.3	—		
Reverse Recovery Time	t _{RR}	—	24.5	—		
Reverse Recovery Charge	Q _{RR}	—	8.3	—	nC	I _F = 15A, di/dt = 300A/µs

Electrical Characteristics Q2 (@T_A = +25°C, unless otherwise specified.)

Characteristic	Symbol	Min	Typ	Max	Unit	Test Condition
OFF CHARACTERISTICS (Note 7)						
Drain-Source Breakdown Voltage	BV _{DSS}	30	—	—	V	V _{GS} = 0V, I _D = 250μA
Zero Gate Voltage Drain Current T _J = +25°C	I _{DSS}	—	—	1.0	μA	V _{DS} = 20V, V _{GS} = 0V
Gate-Source Leakage	I _{GSS}	—	—	±100	nA	V _{GS} = ±10V, V _{DS} = 0V
ON CHARACTERISTICS (Note 7)						
Gate Threshold Voltage	V _{GS(TH)}	0.75	—	1.15	V	V _{DS} = V _{GS} , I _D = 250μA
Static Drain-Source On-Resistance	R _{DS(ON)}	—	5.2	6	mΩ	V _{GS} = 5V, I _D = 15A
Forward Transfer Admittance	Y _{fs}	—	46	—	S	V _{DS} = 5V, I _D = 15A
Diode Forward Voltage	V _{SD}	—	—	1.0	V	V _{GS} = 0V, I _S = 15A
DYNAMIC CHARACTERISTICS (Note 8)						
Input Capacitance	C _{iss}	—	1137	1480	pF	V _{DS} = 15V, V _{GS} = 0V, f = 1.0MHz
Output Capacitance	C _{oss}	—	620	810	pF	
Reverse Transfer Capacitance	C _{rss}	—	24	32	pF	
Gate Resistance	R _g	—	0.54	1.1	Ω	V _{DS} = 0V, V _{GS} = 0V, f = 1MHz
Total Gate Charge (V _{GS} = 4.5V)	Q _g	—	9.7	12.6	nC	V _{DS} = 15V, I _D = 15A
Total Gate Charge at V _{TH}	Q _{g(TH)}	—	0.96	—	nC	
Gate-Source Charge	Q _{gs}	—	1.7	—	nC	
Gate-Drain Charge	Q _{gd}	—	1.2	—	nC	
Turn-On Delay Time	t _{D(ON)}	—	4.4	6.6	ns	V _{DD} = 15V, V _{GS} = 4.5V, I _D = 15A, R _G = 2Ω
Turn-On Rise Time	t _R	—	3.5	—	ns	
Turn-Off Delay Time	t _{D(OFF)}	—	12.4	18.6	ns	
Turn-Off Fall Time	t _F	—	2.9	—	ns	
Reverse Recovery Time	t _{RR}	—	30.5	—	ns	I _F = 15A, di/dt = 300A/μs
Reverse Recovery Charge	Q _{RR}	—	10.8	—	nC	

- Notes:
- Device mounted on FR-4 substrate PC board, 2oz copper, with 1inch square copper plate.
 - I_{AS} and E_{AS} ratings are based on low frequency and duty cycles to keep T_J = +25°C.
 - Short duration pulse test used to minimize self-heating effect.
 - Guaranteed by design. Not subject to product testing.

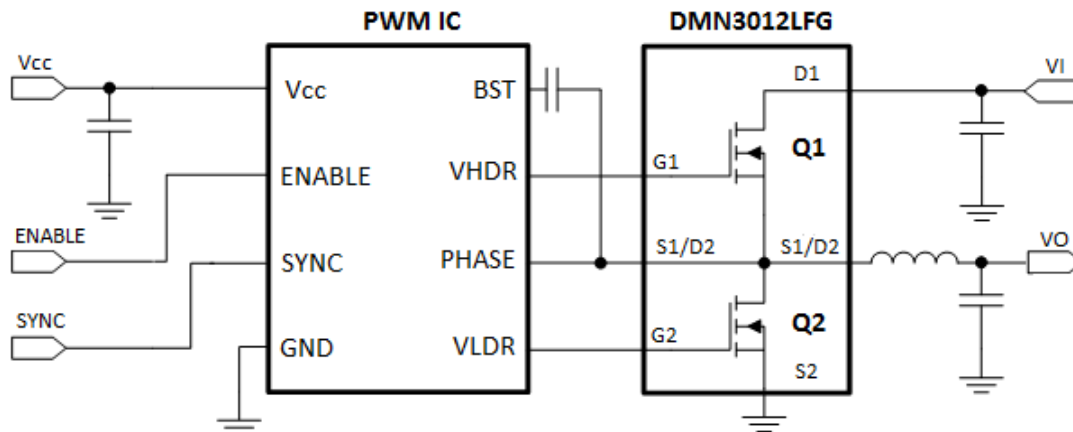
Typical Circuit

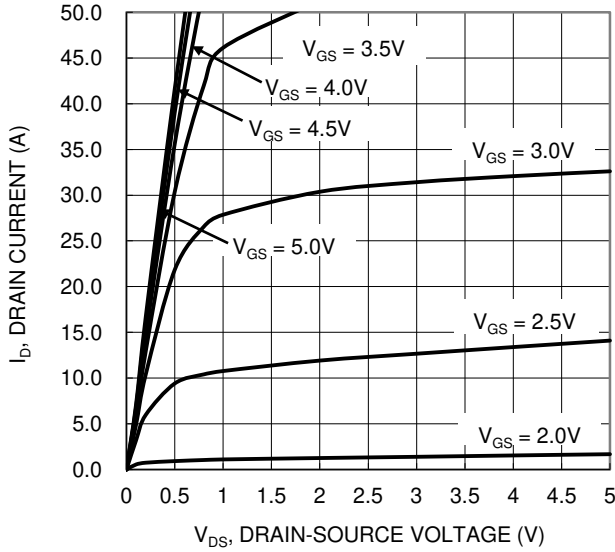

Figure 1. Q1 Typical Output Characteristic

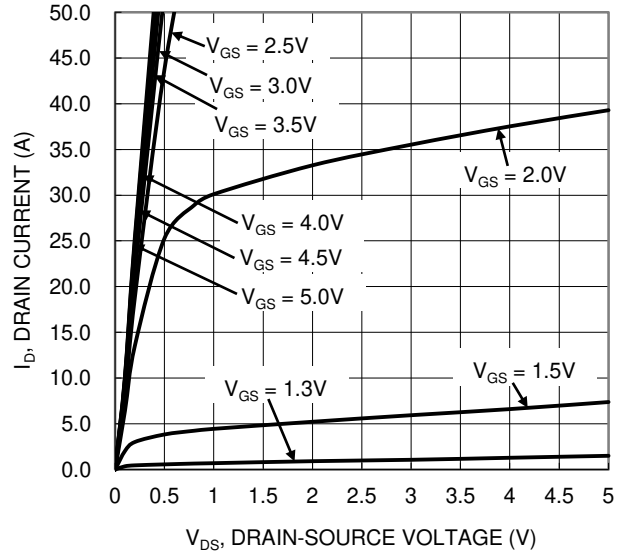

Figure 2. Q2 Typical Output Characteristic

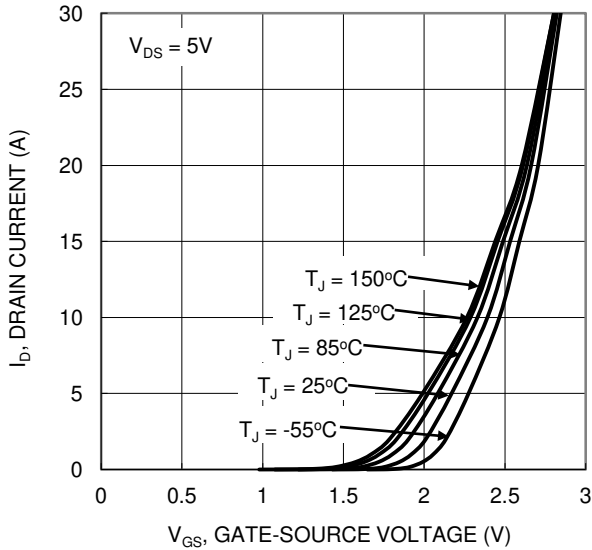

Figure 3. Q1 Typical Transfer Characteristic

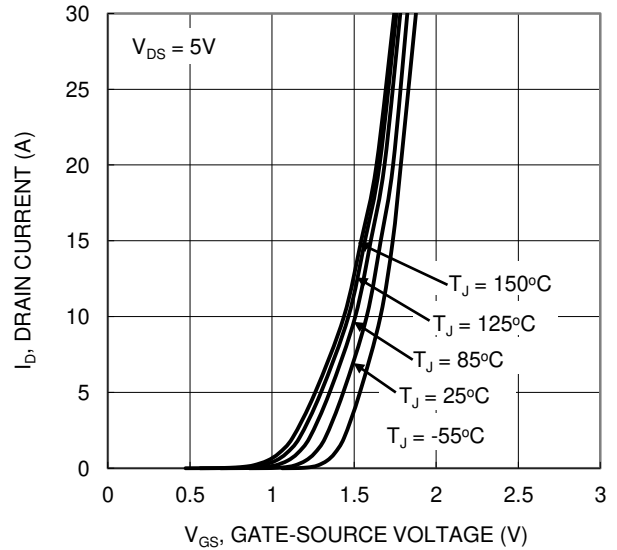

Figure 4. Q2 Typical Transfer Characteristic

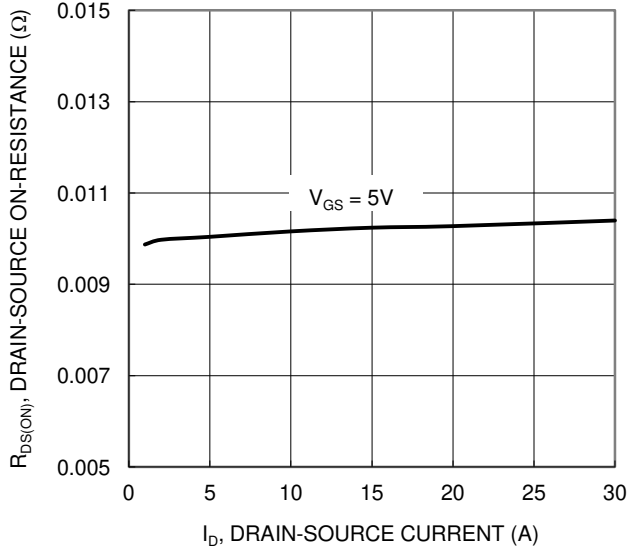

Figure 5. Q1 Typical On-Resistance vs. Drain Current and Gate Voltage

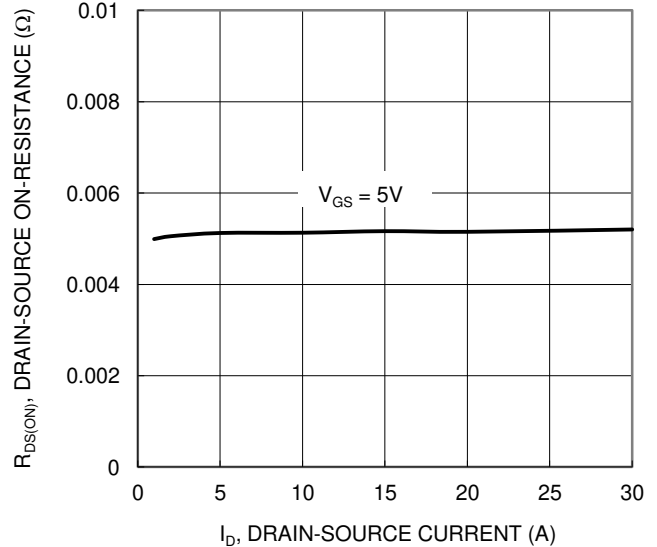

Figure 6. Q2 Typical On-Resistance vs. Drain Current and Gate Voltage

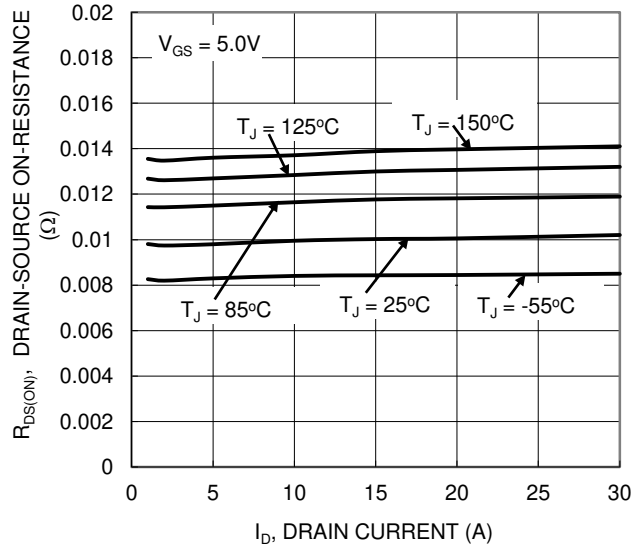

Figure 7. Q1 Typical On-Resistance vs. Drain Current and Temperature

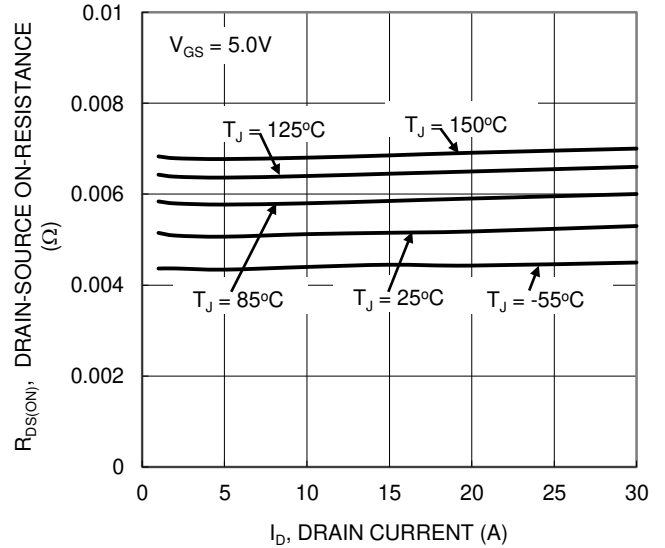

Figure 8. Q2 Typical On-Resistance vs. Drain Current and Temperature

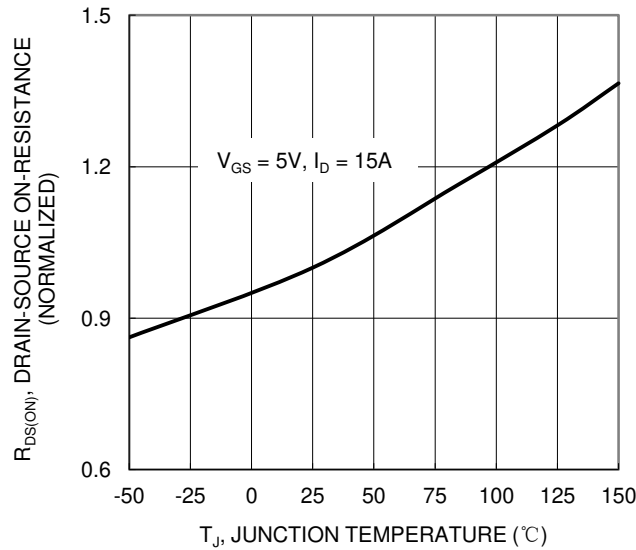

Figure 9. Q1 On-Resistance Variation with Temperature

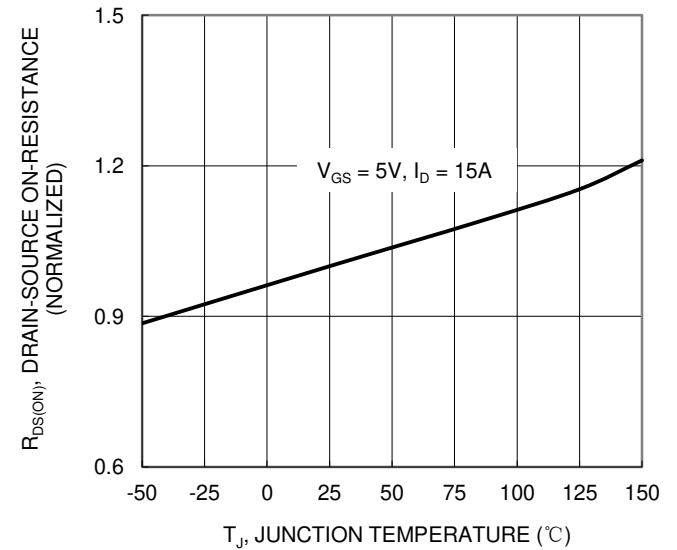

Figure 10. Q2 On-Resistance Variation with Temperature

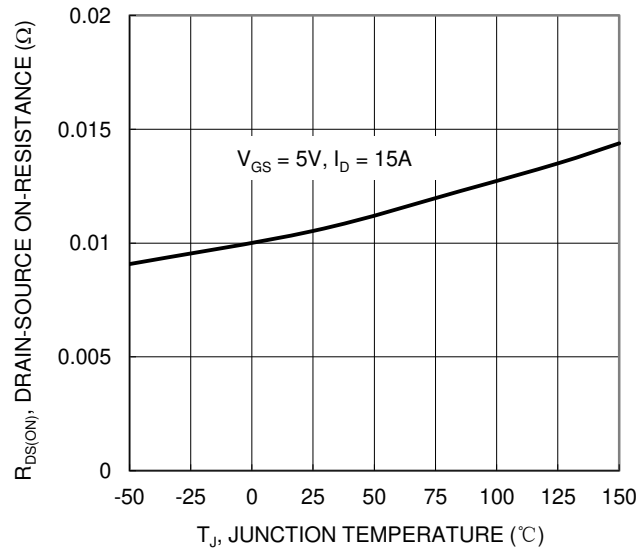

Figure 11. Q1 On-Resistance Variation with Temperature

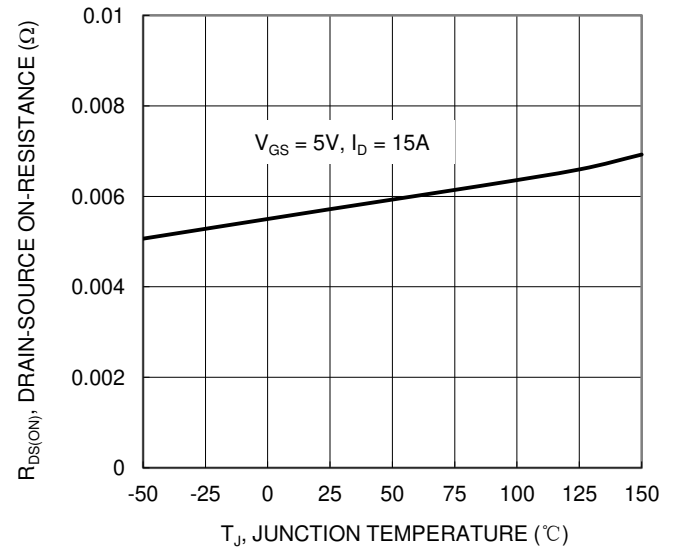

Figure 12. Q2 On-Resistance Variation with Temperature

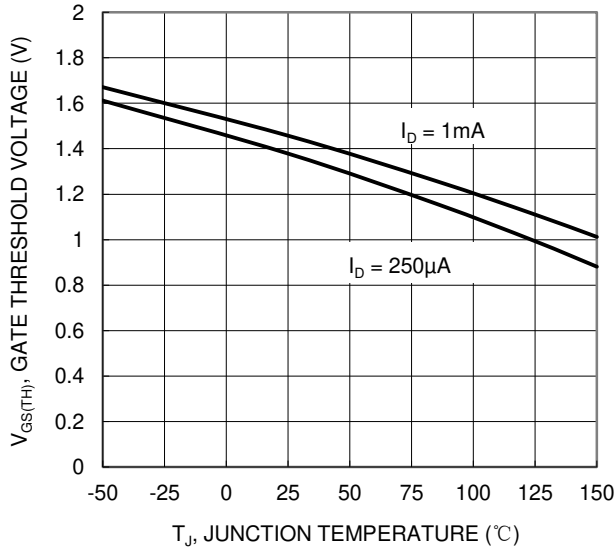

Figure 13. Q1 Gate Threshold Variation vs. Junction Temperature

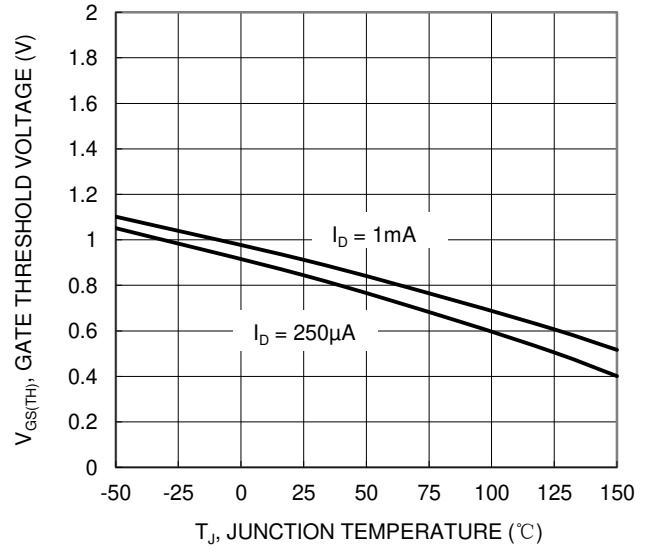

Figure 14. Q2 Gate Threshold Variation vs. Junction Temperature

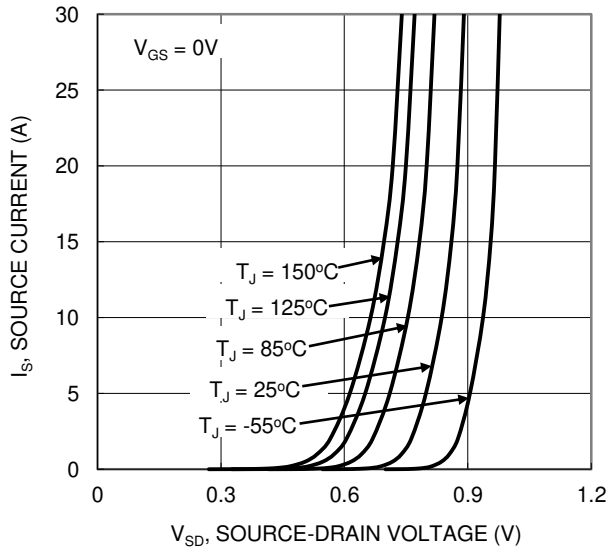

Figure 15. Q1 Diode Forward Voltage vs. Current

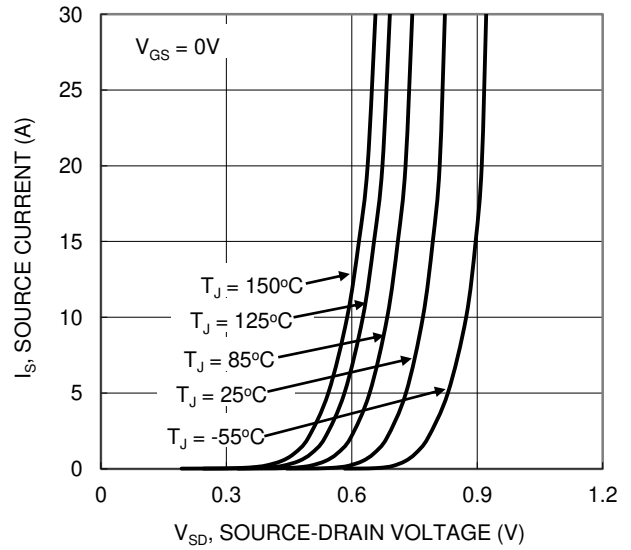

Figure 16. Q2 Diode Forward Voltage vs. Current

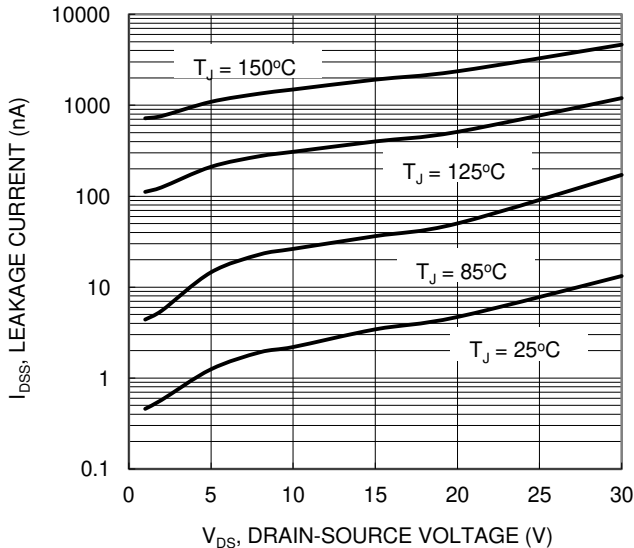

Figure 17. Q1 Typical Drain-Source Leakage Current vs. Voltage

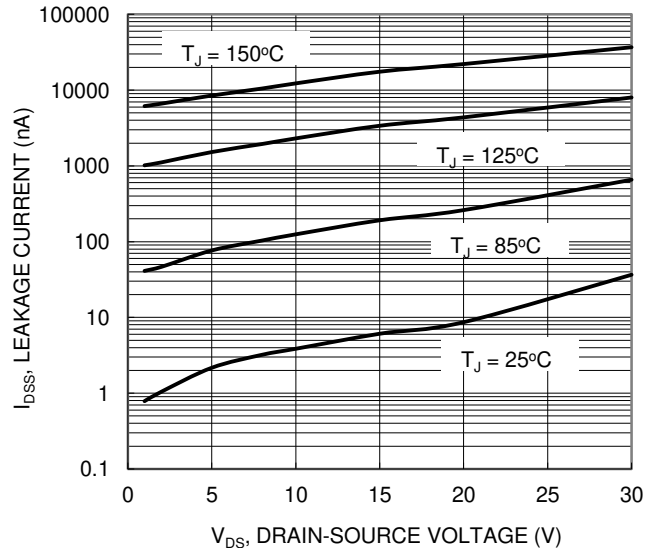

Figure 18. Q2 Typical Drain-Source Leakage Current vs. Voltage

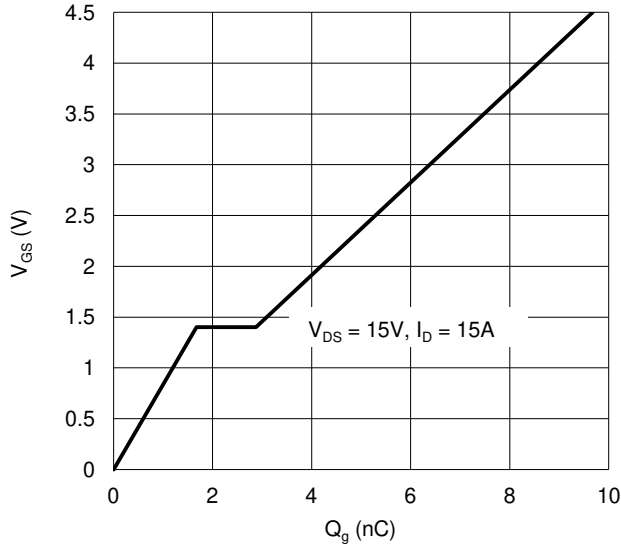

Figure 19. Q1 Gate Charge

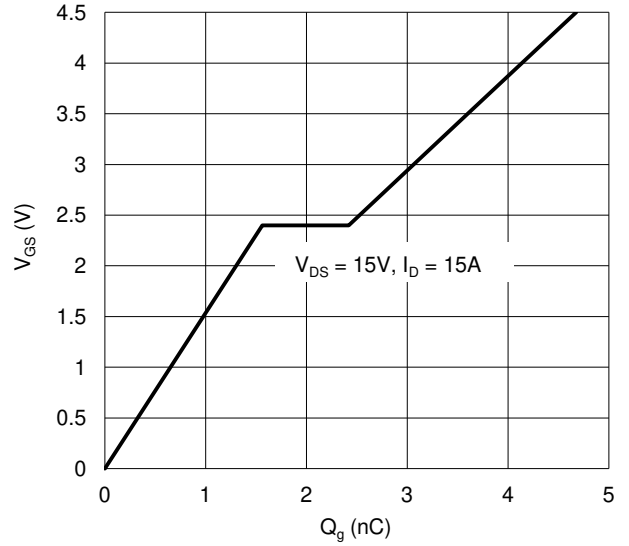

Figure 20. Q2 Gate Charge

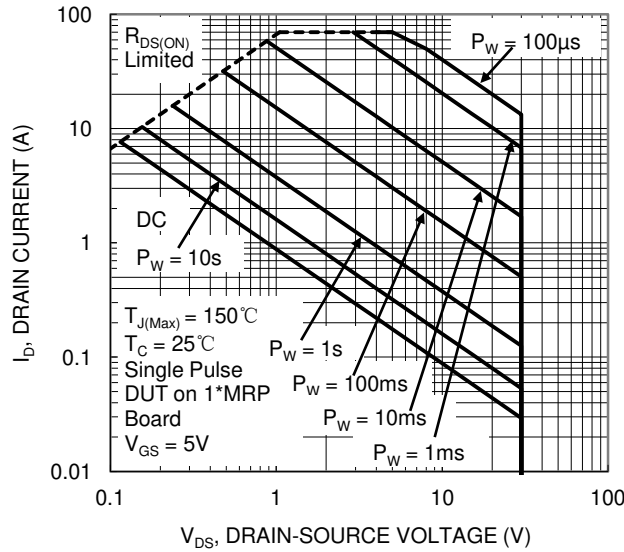

Figure 21. Q1 SOA, Safe Operation Area

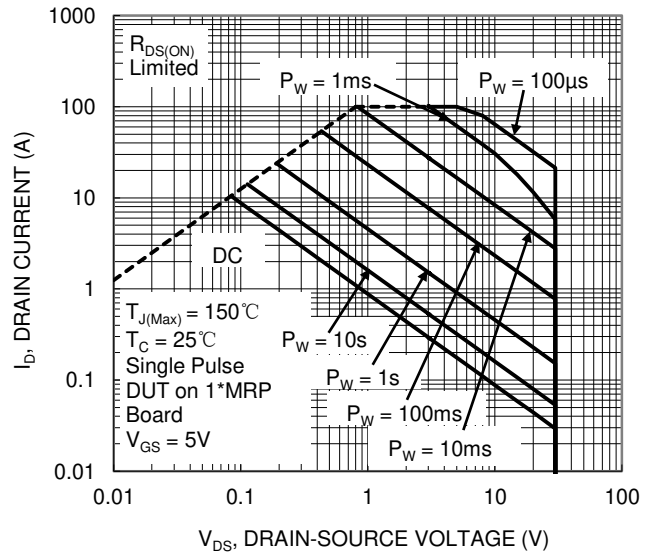

Figure 22. Q2 SOA, Safe Operation Area

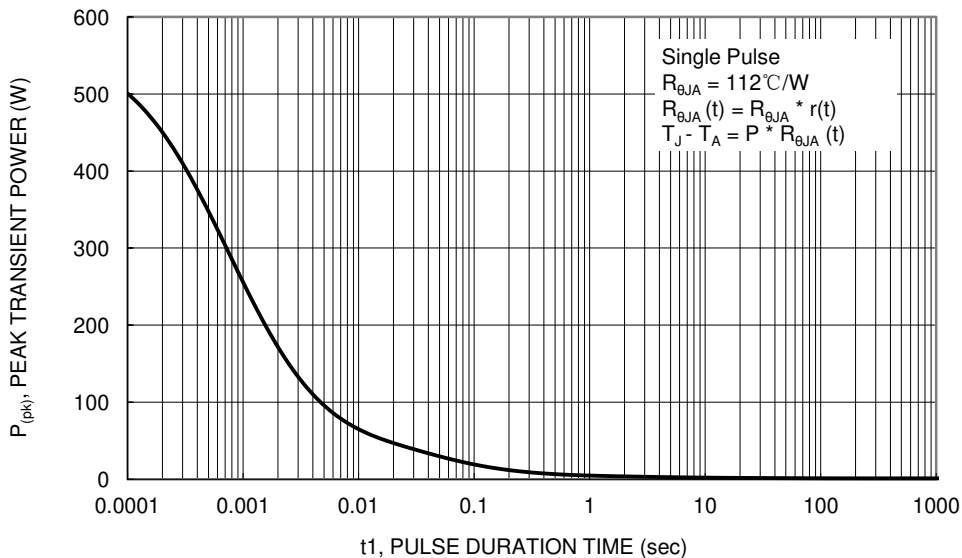

Figure 23. Single Pulse Maximum Power Dissipation

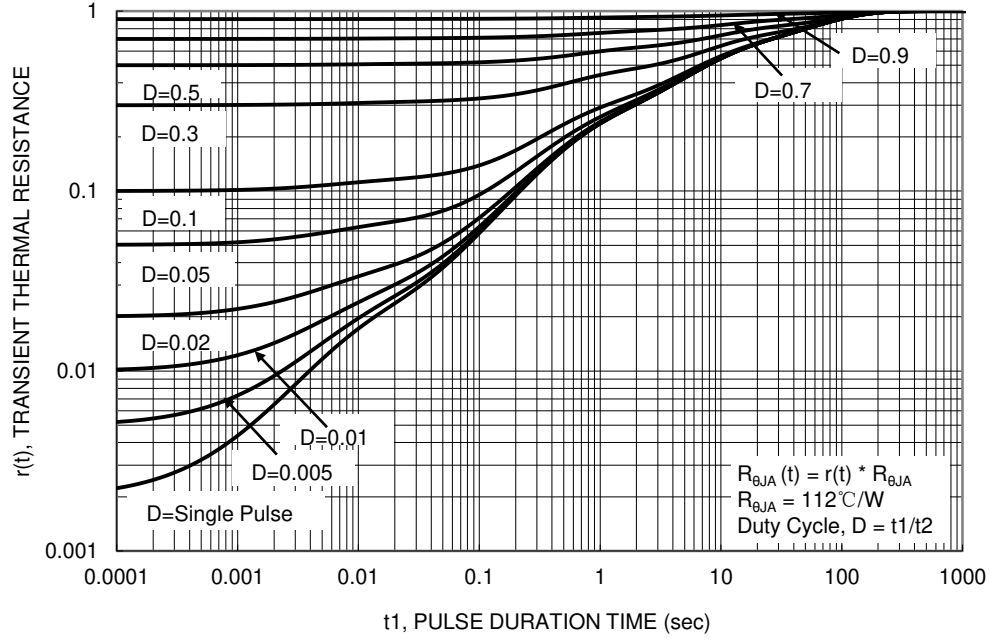
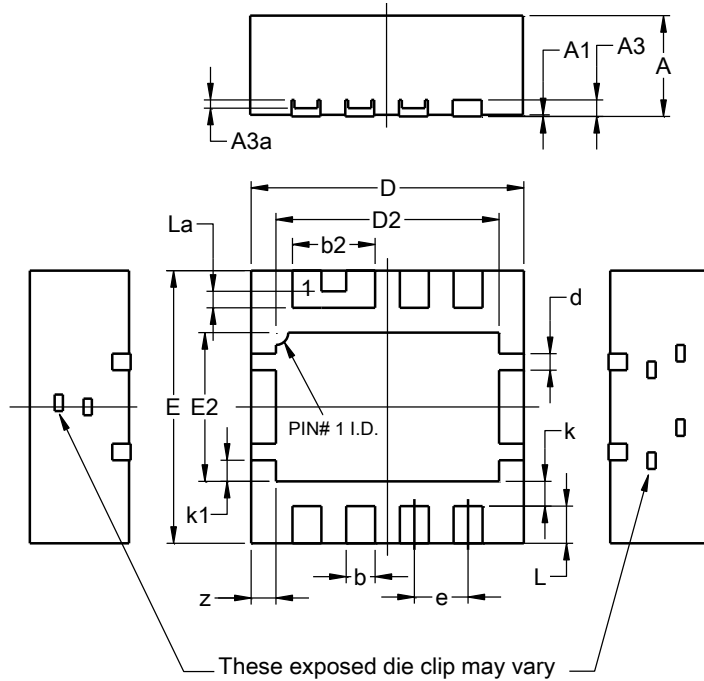

Figure 24. Transient Thermal Resistance

Package Outline Dimensions

Please see <http://www.diodes.com/package-outlines.html> for the latest version.

PowerDI3333-8 (Type D)



PowerDI3333-8 (Type D)			
Dim	Min	Max	Typ
A	1.17	1.23	1.20
A1	0.00	0.05	0.02
A3	0.15	0.25	0.20
A3a	0.05	0.15	0.10
b	0.30	0.40	0.35
b2	0.95	1.05	1.00
D	3.20	3.40	3.30
D2	2.65	2.75	2.70
E	3.20	3.40	3.30
E2	1.75	1.85	1.80
d	0.15	0.25	0.20
e	--	--	0.65
k	--	--	0.30
k1	0.21	0.31	0.26
L	0.40	0.50	0.45
La	0.15	0.25	0.20
z	0.25	0.35	0.30
All Dimensions in mm			

Suggested Pad Layout

Please see <http://www.diodes.com/package-outlines.html> for the latest version.

PowerDI3333-8 (Type D)

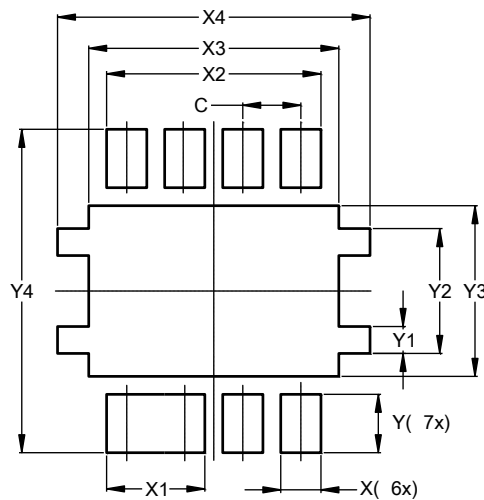

Dimensions	Value (in mm)
C	0.650
X	0.450
X1	1.100
X2	2.400
X3	2.800
X4	3.500
Y	0.650
Y1	0.300
Y2	1.390
Y3	1.900
Y4	3.600

IMPORTANT NOTICE

DIODES INCORPORATED MAKES NO WARRANTY OF ANY KIND, EXPRESS OR IMPLIED, WITH REGARDS TO THIS DOCUMENT, INCLUDING, BUT NOT LIMITED TO, THE IMPLIED WARRANTIES OF MERCHANTABILITY AND FITNESS FOR A PARTICULAR PURPOSE (AND THEIR EQUIVALENTS UNDER THE LAWS OF ANY JURISDICTION).

Diodes Incorporated and its subsidiaries reserve the right to make modifications, enhancements, improvements, corrections or other changes without further notice to this document and any product described herein. Diodes Incorporated does not assume any liability arising out of the application or use of this document or any product described herein; neither does Diodes Incorporated convey any license under its patent or trademark rights, nor the rights of others. Any Customer or user of this document or products described herein in such applications shall assume all risks of such use and will agree to hold Diodes Incorporated and all the companies whose products are represented on Diodes Incorporated website, harmless against all damages.

Diodes Incorporated does not warrant or accept any liability whatsoever in respect of any products purchased through unauthorized sales channel. Should Customers purchase or use Diodes Incorporated products for any unintended or unauthorized application, Customers shall indemnify and hold Diodes Incorporated and its representatives harmless against all claims, damages, expenses, and attorney fees arising out of, directly or indirectly, any claim of personal injury or death associated with such unintended or unauthorized application.

Products described herein may be covered by one or more United States, international or foreign patents pending. Product names and markings noted herein may also be covered by one or more United States, international or foreign trademarks.

This document is written in English but may be translated into multiple languages for reference. Only the English version of this document is the final and determinative format released by Diodes Incorporated.

LIFE SUPPORT

Diodes Incorporated products are specifically not authorized for use as critical components in life support devices or systems without the express written approval of the Chief Executive Officer of Diodes Incorporated. As used herein:

A. Life support devices or systems are devices or systems which:

1. are intended to implant into the body, or
2. support or sustain life and whose failure to perform when properly used in accordance with instructions for use provided in the labeling can be reasonably expected to result in significant injury to the user.

B. A critical component is any component in a life support device or system whose failure to perform can be reasonably expected to cause the failure of the life support device or to affect its safety or effectiveness.

Customers represent that they have all necessary expertise in the safety and regulatory ramifications of their life support devices or systems, and acknowledge and agree that they are solely responsible for all legal, regulatory and safety-related requirements concerning their products and any use of Diodes Incorporated products in such safety-critical, life support devices or systems, notwithstanding any devices- or systems-related information or support that may be provided by Diodes Incorporated. Further, Customers must fully indemnify Diodes Incorporated and its representatives against any damages arising out of the use of Diodes Incorporated products in such safety-critical, life support devices or systems.

Copyright © 2017, Diodes Incorporated

www.diodes.com