



Chipsmall Limited consists of a professional team with an average of over 10 year of expertise in the distribution of electronic components. Based in Hongkong, we have already established firm and mutual-benefit business relationships with customers from,Europe,America and south Asia,supplying obsolete and hard-to-find components to meet their specific needs.

With the principle of “Quality Parts,Customers Priority,Honest Operation,and Considerate Service”,our business mainly focus on the distribution of electronic components. Line cards we deal with include Microchip,ALPS,ROHM,Xilinx,Pulse,ON,Everlight and Freescale. Main products comprise IC,Modules,Potentiometer,IC Socket,Relay,Connector.Our parts cover such applications as commercial,industrial, and automotives areas.

We are looking forward to setting up business relationship with you and hope to provide you with the best service and solution. Let us make a better world for our industry!



Contact us

Tel: +86-755-8981 8866 Fax: +86-755-8427 6832

Email & Skype: info@chipsmall.com Web: www.chipsmall.com

Address: A1208, Overseas Decoration Building, #122 Zhenhua RD., Futian, Shenzhen, China





DMR20-4/20 Series

Loop-Powered, 4-20 mA LED Display Process Monitors with 2.5V Loop Drop



FEATURES

- 2.5V maximum loop-drop (125 Ω burden) for red LED model!
- Self-powered directly from 4-20 mA current loop, no external power source needed
- Fits round 1.20 inch [30.5 mm] cutouts; less than 1.00 inch [<25.4 mm] behind-the-panel depth
- Easy-to-read, 0.30 inch [7.6 mm] high LED digits with excellent display brightness; available in red or green LEDs
- Supplied with EPDM rubber gasket and hex nut
- High-quality, 20-turn, span (gain) and zero (offset) adjustments
- Gold-plated DIP-switch for range and decimal points: Reliable screw-terminal input connections
- Rugged, polycarbonate, one-piece package
- Protected against dust and water submersion to IP67/NEMA 6

Murata's new DMR20-4/20 loop-powered digital process monitors feature a large, easy-to-read, bright LED display. All operating power is derived directly from the current loop itself—no external power source is required! The large, 0.30 [7.6 mm] digits exhibit uniform intensity over the entire 4-20 mA operating range. Unlike other loop-powered LED displays, the total maximum loop voltage drop for the red LED model is 2.5V! Users no longer have to settle for difficult-to-read LCD displays in loop-powered applications.

Both gain (span) and offset (zero) adjustments are performed with on-board, precision, 20-turn potentiometers. All decimal-point and range-change selections are made on a six-position DIP switch featuring vibration-resistant, gold-plated contacts. Unlike competitive meters, there are no jumpers or solder gaps to open or close. Connections to the current loop are made via a reliable, two-position, screw-type terminal block.

The DMR20-4/20's DIP-switch and potentiometers accommodate hundreds of different input-current/output-reading combinations. This versatility eliminates the need to order more costly, long-lead-time custom meters in applications in which several different-range meters are required. The round plastic housing fits standard 1.20" [30.5mm] panel cutouts. An EPDM rubber gasket and hex nut simplify installation and provide IP67/NEMA 6 protection to environmental dirt and moisture.

SIMPLIFIED SCHEMATIC DIAGRAM

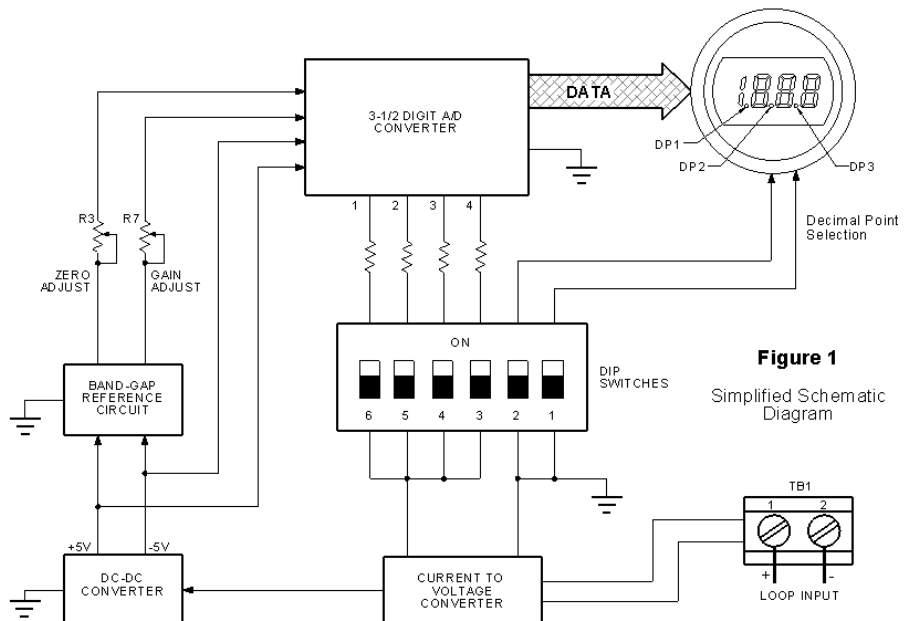

Figure 1
Simplified Schematic Diagram



For full details go to:
<http://www.murata-ps.com/en/support/rohs-compliance.html>

Performance/Functional Specifications

Typical at T_A = +25°C, unless otherwise noted.

Current Loop Input	Min.	Typ.	Max.	Units
Full Scale Input Range ①	+4	–	+20	mA
Input Impedance ②	–	175		Ω
Loop Voltage Drop - Red LED ②	–	2.2	2.5	Volts
Loop Voltage Drop - Green LED		3.2	3.5	Volts
Overcurrent Protection ①	–	–	±40	mA
Performance				
Sampling Rate	2.5 readings per second			
Accuracy (1 minute warm-up)	±0.05% FS ±2 Count			
Temperature Drift (0 to +60°C)	–	±0.15	±0.3	Cnts/°C
Display				
Display Type and Size	3½ digit, 0.30" / 7.6 mm high red LED			
Polarity Indication	"–" for negative reading			
Overrange Indication	"–1____" for negative Vin "1____" for positive Vin			
Physical/Environmental				
Operating Temperature	0	–	+60	°C
Storage Temperature	–40	–	+75	°C
Humidity (non-condensing)	0	–	85	%
Case Material	Polycarbonate			
Weight	0.65 ounces (18.5 grams)			

① The DMR20-4/20, using any of the DIP-switch settings described above, can withstand overcurrents, including those resulting from accidental reverse-polarity connections, up to ±40 mA without sustaining any damage.

② Because DMR20-4/20 loop-powered meters employ active circuitry to convert the loop current into a voltage; the meters' effective series impedance varies in a manner that maintains the loop voltage drop relatively constant over the full 4-to-20 mA current range. Listed input impedance specification applies at 20 mA with all DIP switches set to OFF.

③ When looking up DIP-switch settings in the following Tables and the desired display readings can be achieved with either of two different settings, using the higher setting # will produce less sensitive offset (R3) and span (R7) adjustments. Please keep in mind that the accuracy specification of ±2 counts means it may not always be possible to obtain the exact desired display reading.

Ordering Information

DMR20-4/20S-R-C Unipolar, loop-powered red LED meter
DMR20-4/20S-G-C Unipolar, loop-powered green LED meter
DMR20-4/20B-R-C Unipolar, loop-powered red LED meter

Note: An M30 x 1.5 nylon metric hex nut and EPDM sealing gasket are supplied with each meter. The "–C" suffix indicates RoHS compliance

Panel Knockout Tools:

DMR20-1-KP 1.22" [30.9 mm] punch (no keying notch)
DMR20-2-KP 1.21" [30.7 mm] punch with 4 keying notches
DMR20-3-KP Keyway Punch tool

OPERATING AND SETUP INSTRUCTIONS

DMR20-4/20S (Unipolar Reading Model)

As shipped, the DMR20-4/20S is factory calibrated to read "000" for a 4 mA input and "1000" for a 20 mA input. The following worst-case procedure assumes the DMR20-4/20S is completely misadjusted, i.e., both potentiometers and the DIP switches are randomly set. When performing DIP-switch settings, be sure the DIP switch's small actuators are firmly engaged in their fully-ON or fully-OFF positions.

1. Set R7 (full scale span/gain adjust) and R3 (zero/offset adjust) fully counterclockwise, roughly 22 turns, and set SW1-SW6 to OFF.
2. Select DIP switch setting #2 in Table 1.
3. Apply a precision 4 mA input to TB1 with proper polarity, and adjust R3 until the meter's display reads "000."
4. Apply a precision 20 mA input and adjust R7 until the meter's display reads "1000." Repeat steps 3 and 4 to make sure the adjustments do not affect one another.
5. If required, select the appropriate decimal point by setting SW1 and SW2 per the settings shown in Table 3.

NOTE: If a display reading other than "000" to "1000" is desired, refer to DIP-Switch Settings Table 1 below for SW3-SW6 settings.

Table 1

DMR20-4/20S (Unipolar Model) DIP-Switch Settings

Display Readings

	4 mA	20 mA	SW3	SW4	SW5	SW6
1	000	to 1200-1999	Off	Off	Off	Off
2	000	to 750-1350	On	Off	Off	Off
3	000	to 500-850	Off	On	Off	Off
4	000	to 350-600	Off	Off	On	Off
5	000	to 250-350	On	On	On	Off
6	000	to 150-250	On	Off	On	On

Examples (DMR20-4/20S-Unipolar Models)

1. Desired display readings are:

4 mA = "0.00"
 20 mA = "6.00"

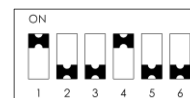

Use DIP-switch setting #3 in Table 1 and enable decimal point DP2 by setting SW1 to 'On' and SW2 to 'Off'. Apply 4 mA and adjust R3 so the display reads "0.00." Apply 20 mA and adjust R7 so the display reads "6.00."

2. Desired display readings are:

4 mA = "000"
 20 mA = "800"

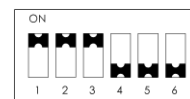

Use DIP-switch setting #2 in Table 1. Apply 4 mA and adjust R3 so the display reads "000." Apply 20 mA and adjust R7 so the display reads "800." For these display readings, no decimal points are used so set SW1 and SW2 both to On.

3. Desired display readings are:

4 mA = "000"
12 mA = "250"

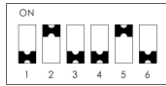

This example is not as straightforward as the previous two. Notice that 12 mA is exactly halfway between 4 mA and 20 mA. If we assume that the input could go up to 20 mA, the display reading would then be: 2 x .250 or ".500." From Table 1 we can now select DIP-switch setting #4 and enable DP1 by setting SW1 to Off and SW2 to On. Apply 4 mA and adjust R3 so the display reads "000." Apply 12 mA and adjust R7 so the display reads "250."

DMR20-4/20B (Bipolar Reading Model)

The DMR20-4/20B's zero-offset circuit differs from the unipolar 'S' model described above in that with the 'B' model, a half-scale 12 mA input is normally set to display "000." Therefore, all of the DIP-switch settings in Table 2 assume a reading of "000" is desired with a 12 mA input.

When configuring the DMR20-4/20B for the first time, or when selecting a new range, set both R3 and R7 fully counterclockwise (roughly 22 turns) to their minimum offset/minimum-span positions, respectively. Then select the desired readings from Table 2 and configure DIP-switches SW3, SW4, SW5, and SW6 accordingly.

The procedure below illustrates how to calibrate the DMR20-4/20B to its factory-calibrated readings of "-1000" with a 4 mA input and "1000" with a 20 mA input. When performing DIP-switch settings, be sure the DIP-switch's small actuators are firmly engaged in their fully-ON or fully-OFF positions.

1. Set both R3 and R7 fully counterclockwise.
2. Select DIP-switch setting #1 from Table 2.
3. Apply a precision 12 mA input and adjust R3 until the meter's display reads "000."
4. Apply a precision 20 mA input and adjust R7 until the meter's display reads "1000."
5. Apply a precision 4 mA input and the display should read "-1000." Repeat steps 3 and 4 to make sure the two adjustments did not affect one another.

Table 2
DMR20-4/20B (Bipolar Model) DIP-Switch Settings

	4 mA	12 mA	20 mA	SW3	SW4	SW5	SW6
1	-600 to -1000	000	600 to 1000	Off	Off	Off	Off
2	-400 to -600	000	400 to 600	On	Off	Off	Off
3	-250 to -400	000	250 to 400	Off	On	Off	Off
4	-150 to -250	000	150 to 250	Off	Off	On	Off
5	-100 to -150	000	100 to 150	On	Off	On	On
6	-70 to -100	000	70 to 100	Off	On	On	On

Examples (DMR20-4/20B-Bipolar Model)

1. Desired display readings are:

4 mA = "-1.00"
20 mA = "1.00"

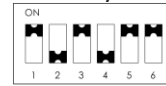

Use DIP-switch setting #5 in Table 2 and enable decimal point DP2 by setting SW1 to 'On' and SW2 to 'Off'. Apply 12 mA and adjust R3 so the display reads "0.00." Apply 20 mA and adjust R7 so the display reads "1.00." Apply 4 mA and verify that the display reads "-1.00," readjust R3 and R7 if necessary.

2. Desired display readings are:

4 mA = "-450"
20 mA = "450"

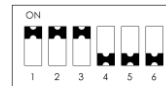

Use DIP-switch setting #2 in Table 2. Apply 12 mA and adjust R3 so the display reads "000." Apply 20 mA and adjust R7 so the display reads "450." Apply 4 mA and verify that the display reads "-450." Repeat adjustment procedure if necessary. For these display readings, no decimal points are used, so set SW1 and SW2 to On.

3. Desired display readings are:

4 mA = "-650"
20 mA = "650"



Select DIP-setting # 1 in Table 2. Apply 12 mA and adjust R3 so the display reads "000." Apply 20 mA and adjust R7 so the display reads "650." Apply 4 mA and verify that the display reads "-650." Repeat adjustment procedure if necessary. For these display readings, no decimal points are used, so set SW1 and SW2 to On.

Table 3
Decimal Point Settings (All Models)

SW1	SW2	Decimal Point
Off	Off	DP3
On	Off	DP2
Off	On	DP1
On	On	None

CONNECTION DIAGRAM

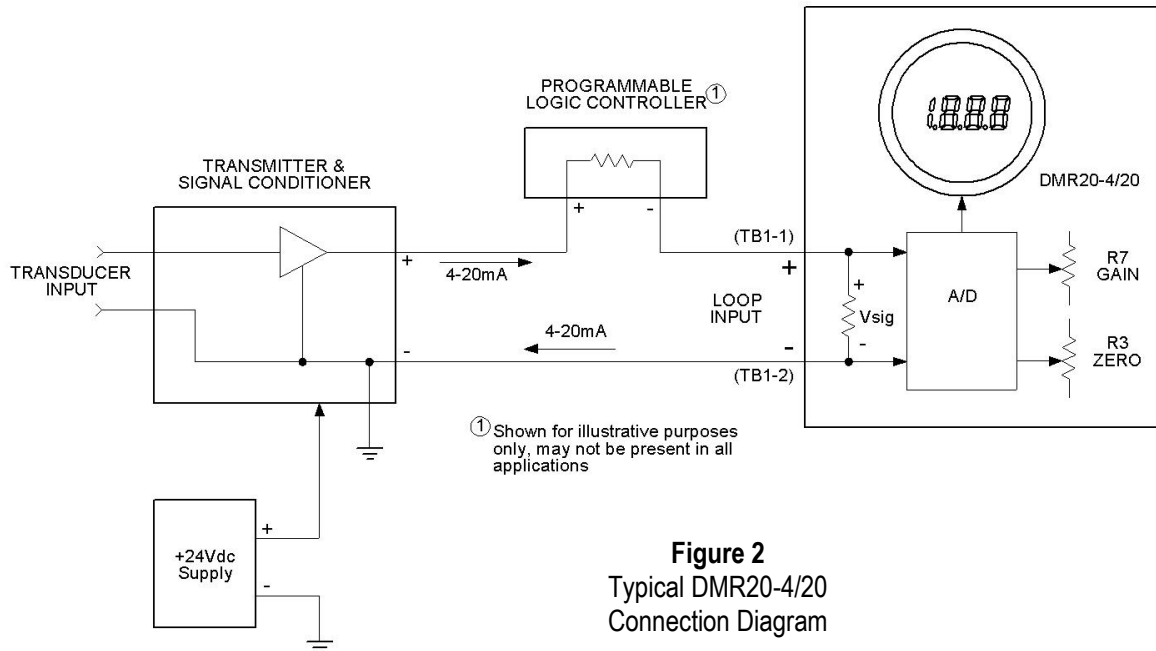

Figure 2
 Typical DMR20-4/20
 Connection Diagram

INSTALLATION DIAGRAM

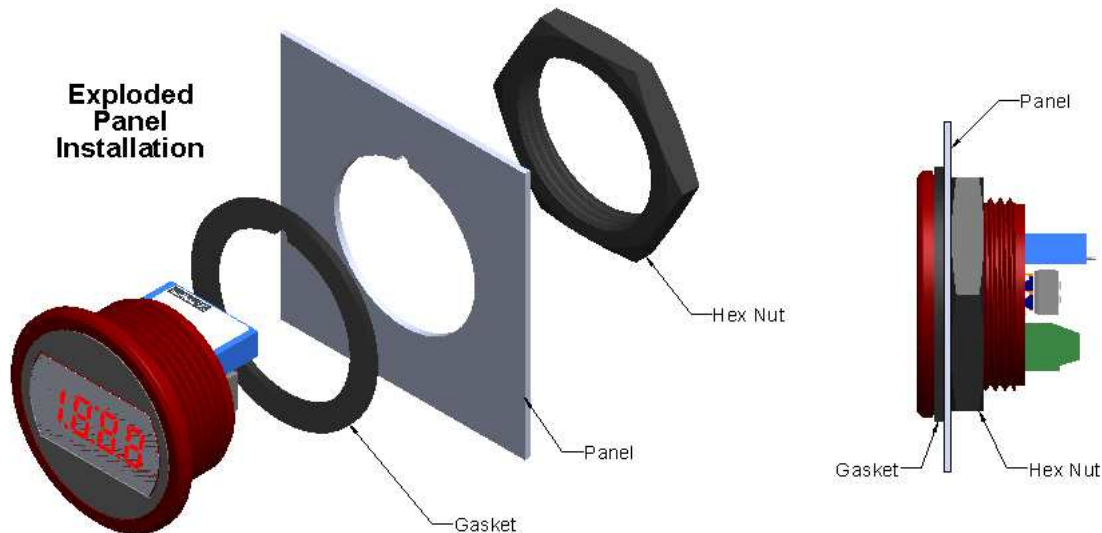
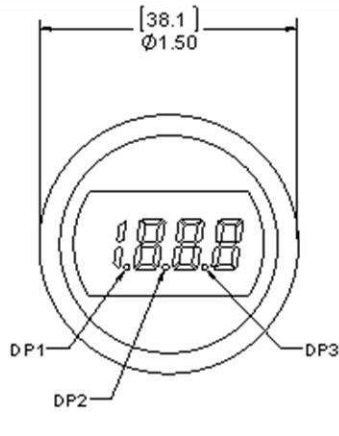
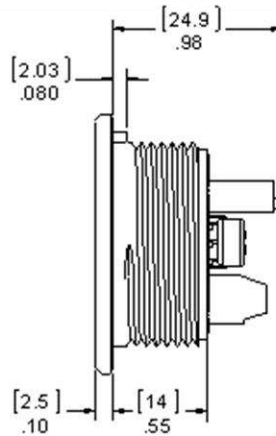

Figure 3
 Panel Installation

MECHANICAL SPECIFICATIONS AND RECOMMENDED PANEL CUTOUT



Front View



Side View

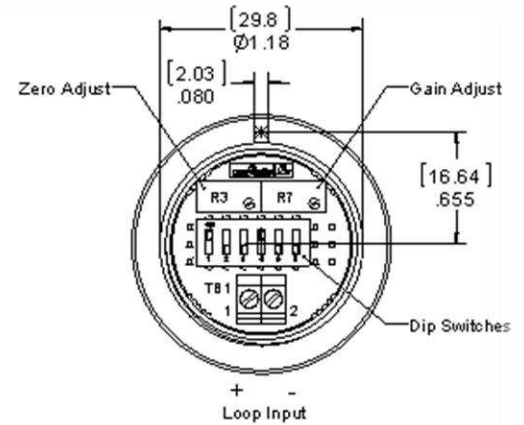

Rear View

Mechanical Outline

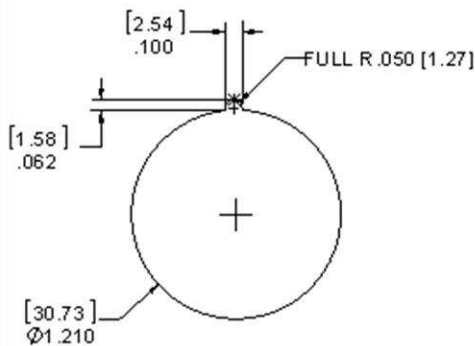

Recommended Panel Cutout

UNLESS OTHERWISE SPECIFIED:

Dimensions are in Inches [mm]

Tolerances:

.XX ±.02 [0.5]

.XXX ±.010 [.25]

Angles: ±2°

Components are shown for Reference Only

3D Models are available at:

<http://www.murata-ps.com/en/3d/meters.html>

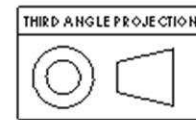

Available Panel Knockout Tools

DMR20-1-KP	1.22" [30.9 mm] punch (no keying notch)
DMR20-2-KP	1.21" [30.7 mm] punch with 4 keying notches
DMR20-3-KP	Keyway Punch tool

Recommended Terminations at TB1

WIRE SIZE: 18 to 26 AWG (Solid or stranded)
STRIPPING LENGTH: 0.20" [5.1 mm] Nominal

