



Chipsmall Limited consists of a professional team with an average of over 10 year of expertise in the distribution of electronic components. Based in Hongkong, we have already established firm and mutual-benefit business relationships with customers from,Europe,America and south Asia,supplying obsolete and hard-to-find components to meet their specific needs.

With the principle of “Quality Parts,Customers Priority,Honest Operation,and Considerate Service”,our business mainly focus on the distribution of electronic components. Line cards we deal with include Microchip,ALPS,ROHM,Xilinx,Pulse,ON,Everlight and Freescale. Main products comprise IC,Modules,Potentiometer,IC Socket,Relay,Connector.Our parts cover such applications as commercial,industrial, and automotives areas.

We are looking forward to setting up business relationship with you and hope to provide you with the best service and solution. Let us make a better world for our industry!



## Contact us

Tel: +86-755-8981 8866 Fax: +86-755-8427 6832

Email & Skype: info@chipsmall.com Web: www.chipsmall.com

Address: A1208, Overseas Decoration Building, #122 Zhenhua RD., Futian, Shenzhen, China





## 1. Product Characteristics:

### 1.1 General Description

Model DMS060250-P5P-SZ is a universal switching-mode power supply, operating at input voltage 90VAC to 264VAC and output voltage of 6VDC with 2.5A DC load.

### 1.2 Electric Characteristics

#### 1.2.1 Input

NO	ITEM	SPECIFICATION
1	Rated input Voltage	AC100V-240V
	Vibration input Voltage Range	AC90V-264V
2	Frequency Rated	50-60Hz
	Frequency Vibration	47-63Hz
3	Input Rated Current	600mA RMS Max
	Inrush Current	30A Max. at 115vac cool start
		60A Max. at 230vac cool start
4	Leakage current	0.25 mA
5	Efficiency	60% Min

### 1.2.2 Output:

No	ITEM	SPECIFICATION
1	*output Voltage	+6VDC
2	*output max. current	2.5A
3	output min. Current	0A
4	Line regulation	± 1%
5	Load regulation	± 5%
6	Over voltage protection	7.13V to 7.88V DC ( output shut down)
7	Short circuit protection	Output shut down and auto restart
8	Ripple Voltage (L.F.)	150mV (p-p) (100V-240VAC Input)

### 1.2.3 HI-POT SPECIFICATION

Input to output : 3000VAC or 4242VDC 10mA 1 minute.

### 1.2.4 Insulation resistance:

Input to output: 500vdc to test the input to output resistance not be less  
100M ohm

### 1.2.5 Safety approved:UL,CUL,GS,CE

### 1.2.6 EMI standard : meet FCC Class B , VCCI-II , CE



**1.3 Mechanical Characteristics:**

1.3.1 AC Plug : Interchangeable PIN (US/EUROPE/UK/AUS)

1.3.2 DC cord:

1.3.2.1 Bending test: Life 1000 times 100% guarantee. Swings 120 from Left  
to right loading weight 500 gm , 40 cycle/minute.

1.3.2.2 Pull test : DC cord and plug ,weight 10kg for 1 minute.

1.3.3 Cord length and output plug: See Reference Att.4

1.3.4 Weight : 236 g

1.3.5 Case Size:(L) 74 × (W)43.5 × (H)34mm

1.3.6 Normal operating temperature and humidity

1.3.7 Temperature

Operating : 0°C to 40°C.

Storage : -10°C to 70°C.

1.3.8 Humidity

Operating : 20% to 80%.

Storage : 10% to 90%



## 2.Attachment

(Att.1) Label

(Att.2) Outdrawing

(Att.3) Package

(Att.3.1) Package flow chart

(Att.4) Dc Cord drawing

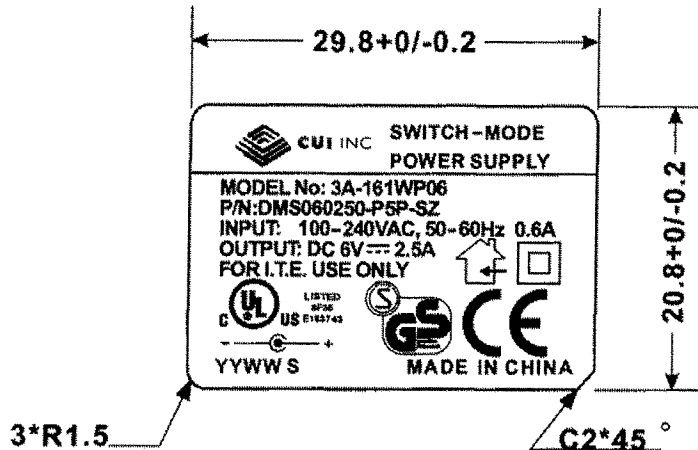

UNIT: mm

YYWW S YY:YEAR WW:WEEK S:FU YONG

ALUMINUM NAMEPLATE: ○ BLACK WORD ON SILVER BASE

○ SILVER WORD ON BLACK BASE

METALIZED POLYESTER: ● BLACK WORD ON SILVER BASE

(SILVER MATTE)

○ SILVER WORD ON BLACK BASE

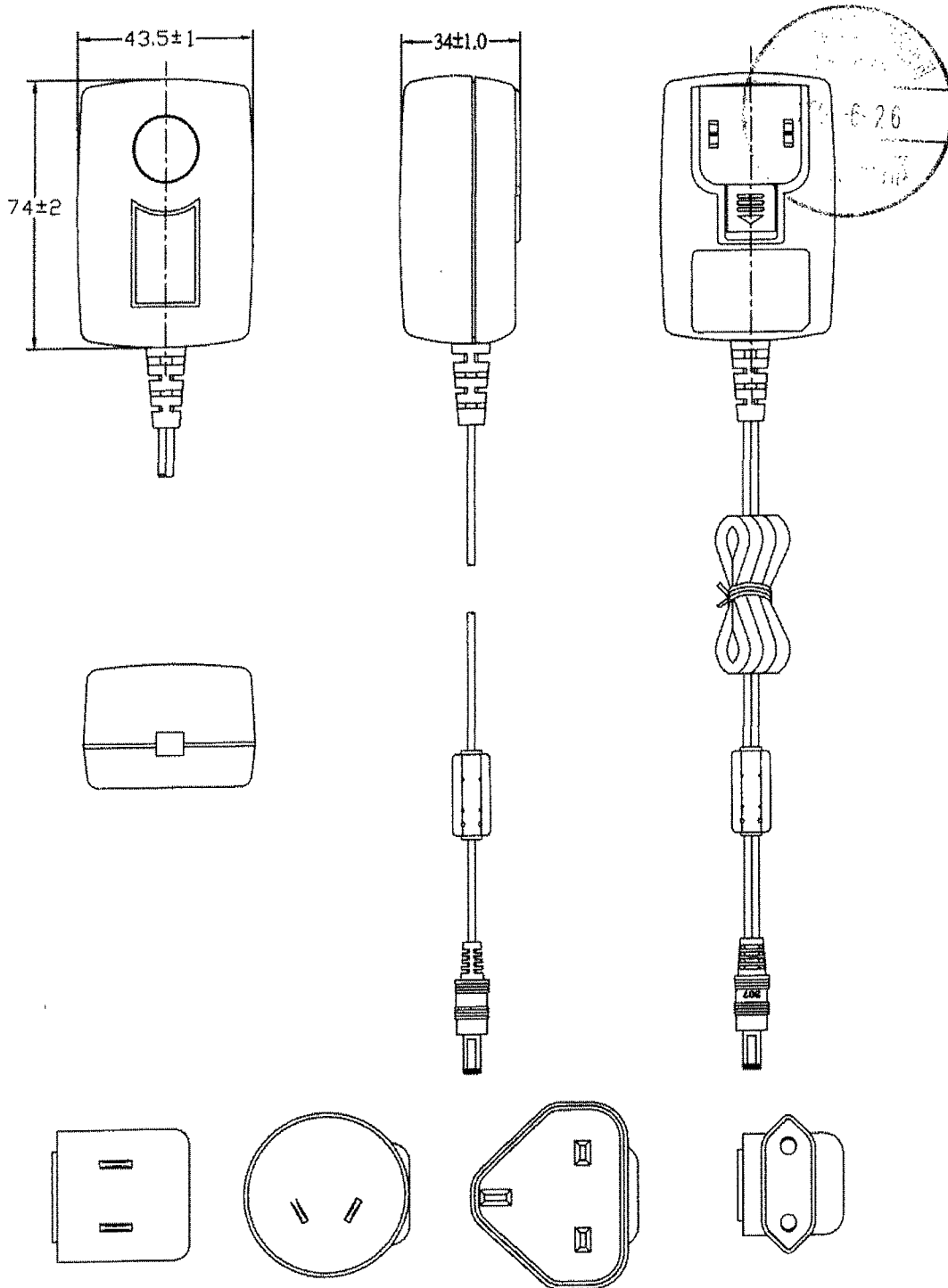





CARTON SIZE: 485X428X210mm

485X428X210mm

Q'TY: 60pcs(20x3x1)

60pcs(20x3x1)

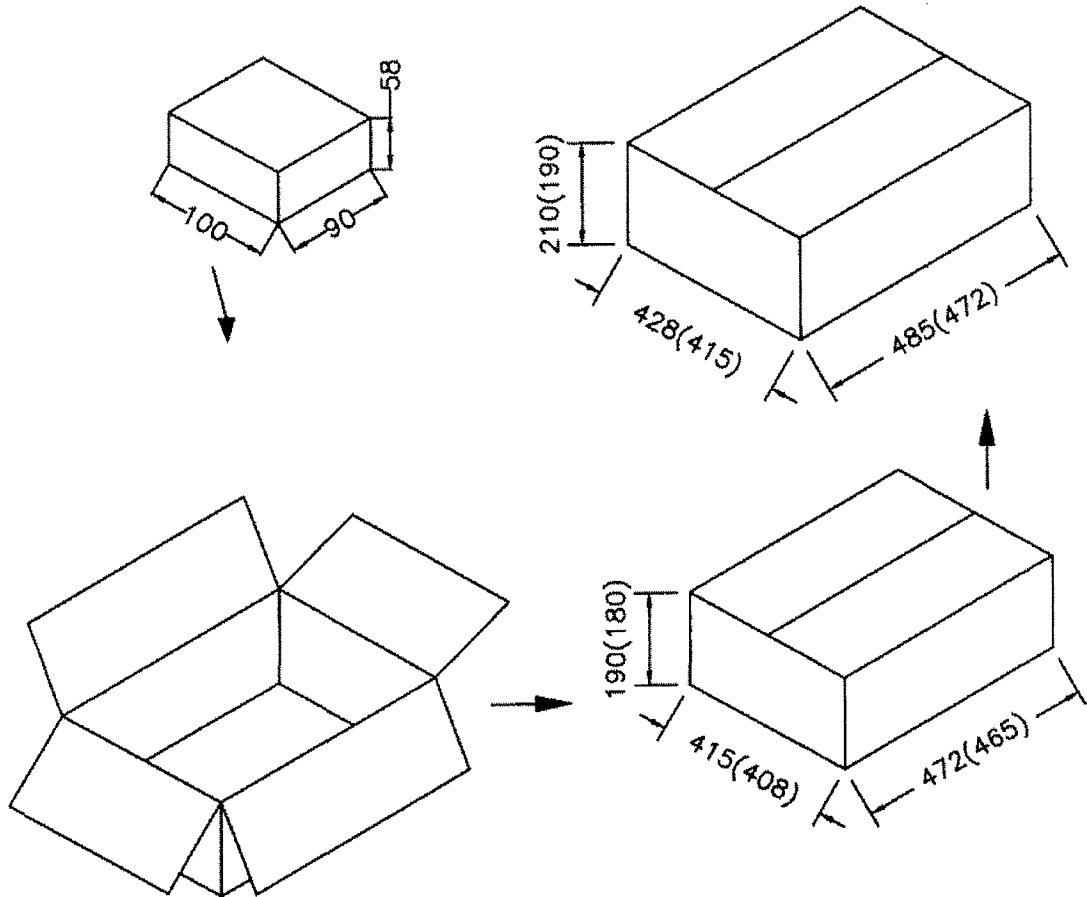

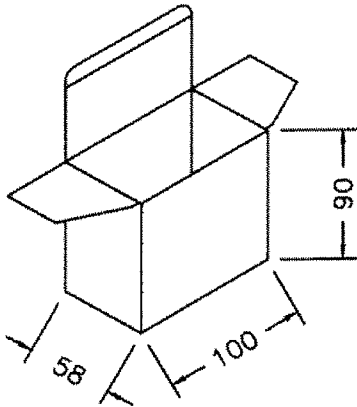
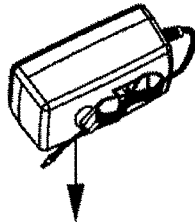
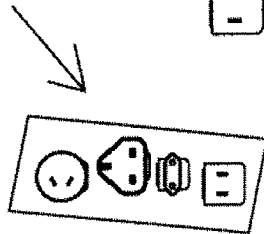
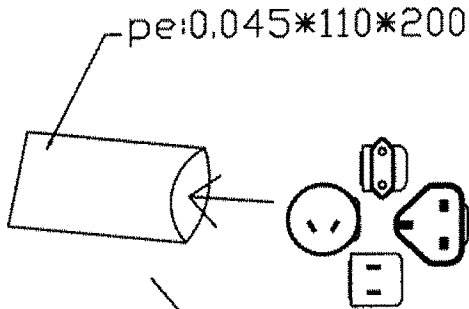

← White Box: NO.13

