



Chipsmall Limited consists of a professional team with an average of over 10 year of expertise in the distribution of electronic components. Based in Hongkong, we have already established firm and mutual-benefit business relationships with customers from,Europe,America and south Asia,supplying obsolete and hard-to-find components to meet their specific needs.

With the principle of “Quality Parts,Customers Priority,Honest Operation,and Considerate Service”,our business mainly focus on the distribution of electronic components. Line cards we deal with include Microchip,ALPS,ROHM,Xilinx,Pulse,ON,Everlight and Freescale. Main products comprise IC,Modules,Potentiometer,IC Socket,Relay,Connector.Our parts cover such applications as commercial,industrial, and automotives areas.

We are looking forward to setting up business relationship with you and hope to provide you with the best service and solution. Let us make a better world for our industry!



Contact us

Tel: +86-755-8981 8866 Fax: +86-755-8427 6832

Email & Skype: info@chipsmall.com Web: www.chipsmall.com

Address: A1208, Overseas Decoration Building, #122 Zhenhua RD., Futian, Shenzhen, China



HiPerFRED²

$$V_{RRM} = 400V$$

$$I_{FAV} = 2 \times 15A$$

$$t_{rr} = 45ns$$

High Performance Fast Recovery Diode
 Low Loss and Soft Recovery
 Common Cathode

Part number

DPG30C400HB

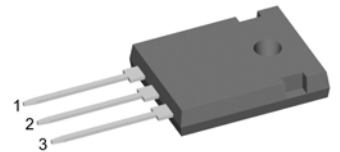

Backside: cathode

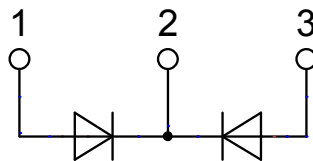
**Features / Advantages:**

- Planar passivated chips
- Very low leakage current
- Very short recovery time
- Improved thermal behaviour
- Very low I_{rm} -values
- Very soft recovery behaviour
- Avalanche voltage rated for reliable operation
- Soft reverse recovery for low EMI/RFI
- Low I_{rm} reduces:
 - Power dissipation within the diode
 - Turn-on loss in the commutating switch

Applications:

- Antiparallel diode for high frequency switching devices
- Antisaturation diode
- Snubber diode
- Free wheeling diode
- Rectifiers in switch mode power supplies (SMPS)
- Uninterruptible power supplies (UPS)

Package: TO-247

- Industry standard outline
- RoHS compliant
- Epoxy meets UL 94V-0

Fast Diode				Ratings			
Symbol	Definition	Conditions	min.	typ.	max.	Unit	
V_{RSM}	max. non-repetitive reverse blocking voltage				400	V	
V_{RRM}	max. repetitive reverse blocking voltage				400	V	
I_R	reverse current, drain current	$V_R = 400\text{ V}$			1	μA	
		$V_R = 400\text{ V}$			0.18	mA	
V_F	forward voltage drop	$I_F = 15\text{ A}$			1.38	V	
		$I_F = 30\text{ A}$			1.61	V	
		$I_F = 15\text{ A}$	$T_{VJ} = 150^\circ\text{C}$			1.13	V
		$I_F = 30\text{ A}$	$T_{VJ} = 150^\circ\text{C}$			1.39	V
I_{FAV}	average forward current	$T_C = 140^\circ\text{C}$ rectangular $d = 0.5$			15	A	
V_{FO}	threshold voltage	} for power loss calculation only			0.84	V	
r_F	slope resistance				15.9	m Ω	
R_{thJC}	thermal resistance junction to case				1.7	K/W	
R_{thCH}	thermal resistance case to heatsink			0.25		K/W	
P_{tot}	total power dissipation				90	W	
I_{FSM}	max. forward surge current	$t = 10\text{ ms}; (50\text{ Hz}), \text{ sine}; V_R = 0\text{ V}$			190	A	
C_J	junction capacitance	$V_R = 200\text{ V}$ $f = 1\text{ MHz}$			16	pF	
I_{RM}	max. reverse recovery current	} $I_F = 15\text{ A}; V_R = 270\text{ V}$			4	A	
					5.5	A	
t_{rr}	reverse recovery time	} $-di_F/dt = 200\text{ A}/\mu\text{s}$			45	ns	
					70	ns	

Package TO-247			Ratings			
Symbol	Definition	Conditions	min.	typ.	max.	Unit
I_{RMS}	RMS current	per terminal ¹⁾			35	A
T_{VJ}	virtual junction temperature		-55		175	°C
T_{op}	operation temperature		-55		150	°C
T_{stg}	storage temperature		-55		150	°C
Weight				6		g
M_D	mounting torque		0.8		1.2	Nm
F_C	mounting force with clip		20		120	N

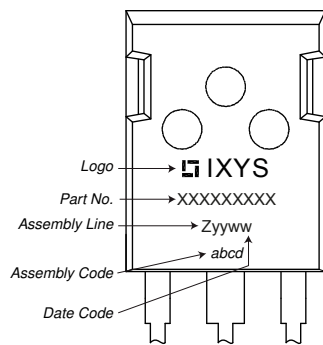
Product Marking

Part number

- D = Diode
- P = HiPerFRED
- G = extreme fast
- 30 = Current Rating [A]
- C = Common Cathode
- 400 = Reverse Voltage [V]
- HB = TO-247AD (3)

Ordering	Part Number	Marking on Product	Delivery Mode	Quantity	Code No.
Standard	DPG30C400HB	DPG30C400HB	Tube	30	505790

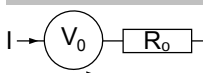
Similar Part	Package	Voltage class
DPG30C400PB	TO-220AB (3)	400

Equivalent Circuits for Simulation
** on die level*
 $T_{VJ} = 175\text{ °C}$

Fast Diode

$V_{0\ max}$	threshold voltage	0.84	V
$R_{0\ max}$	slope resistance *	13.3	mΩ

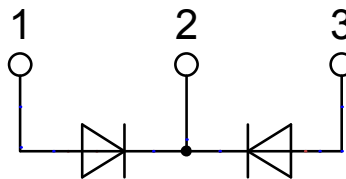
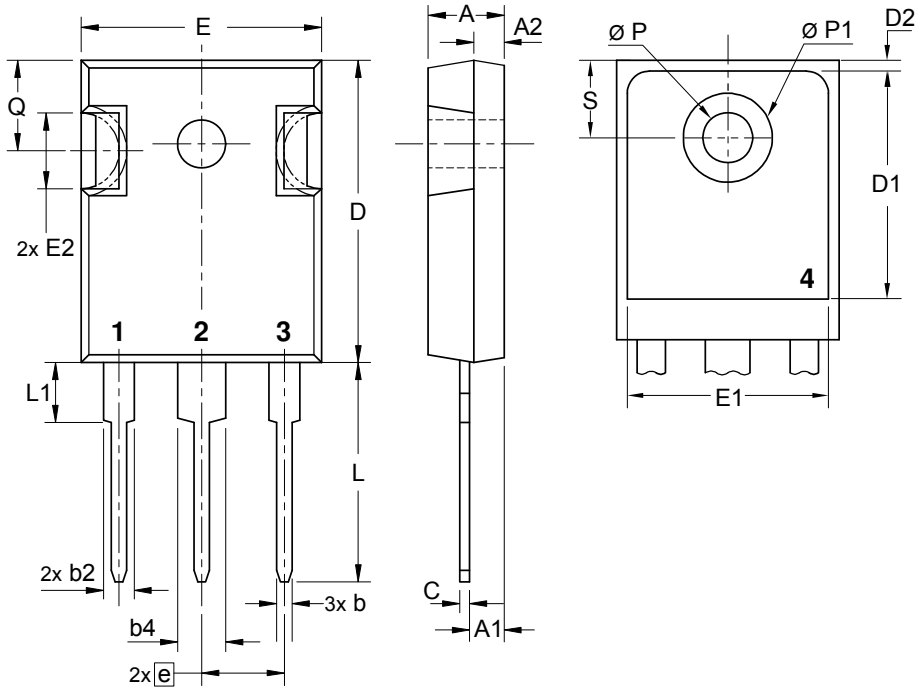
Outlines TO-247



Fast Diode

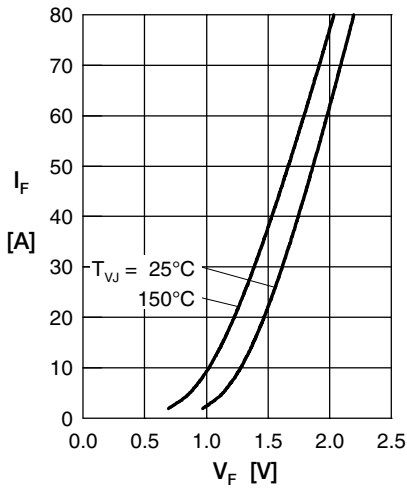

Fig. 1 Forward current I_F versus V_F

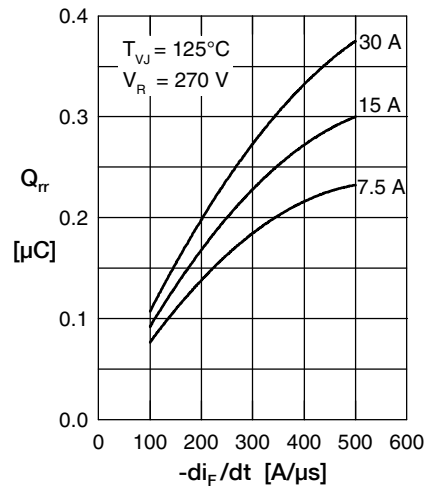

Fig. 2 Typ. reverse recov. charge Q_{rr} versus $-di_F/dt$

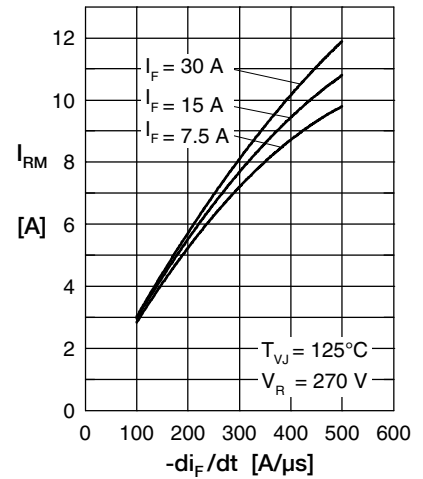

Fig. 3 Typ. peak reverse current I_{RM} versus $-di_F/dt$

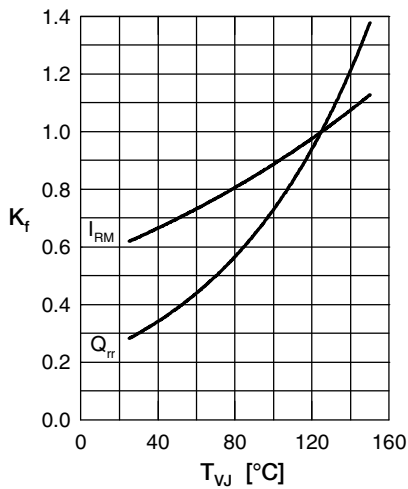

Fig. 4 Typ. dynamic parameters Q_{rr} , I_{RM} versus T_{VJ}

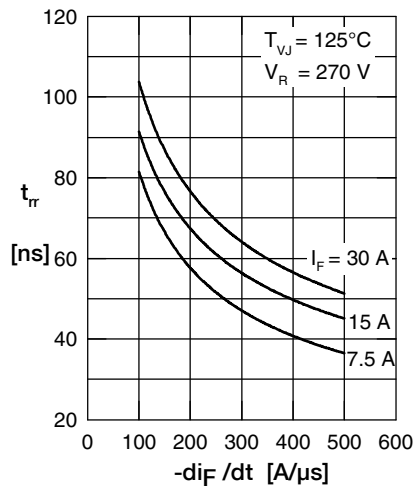

Fig. 5 Typ. recovery time t_{rr} versus $-di_F/dt$

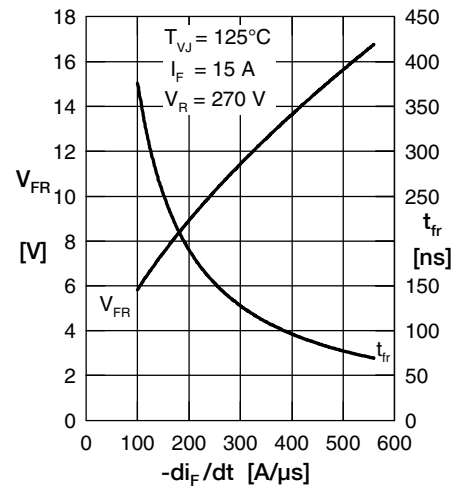

Fig. 6 Typ. peak forward voltage V_{FR} and t_{fr} versus di_F/dt

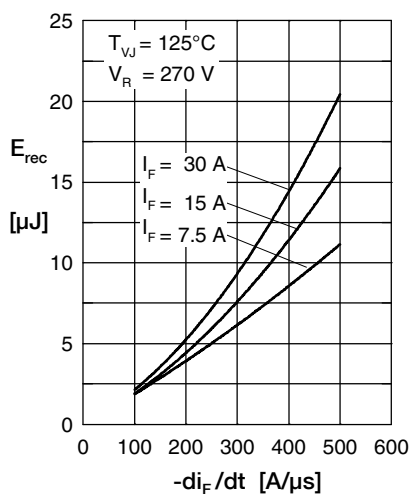

Fig. 7 Typ. recovery energy E_{rec} versus $-di_F/dt$

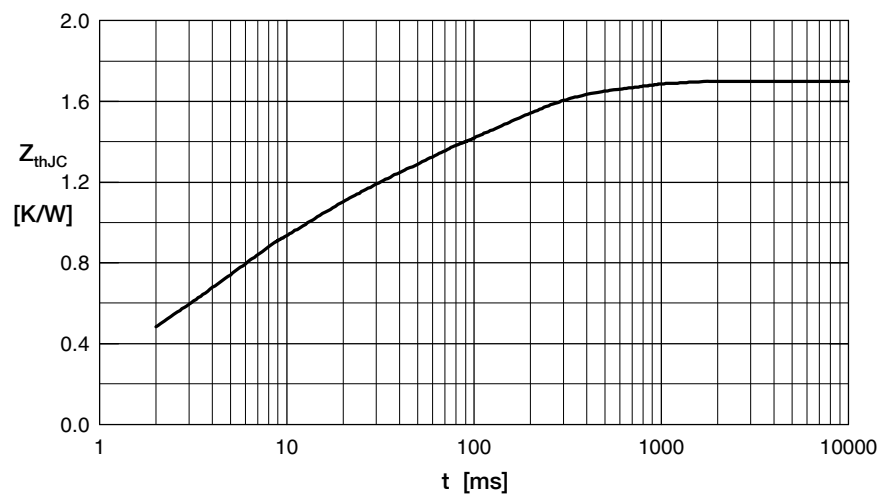

Fig. 8 Transient thermal resistance junction to case