



Chipsmall Limited consists of a professional team with an average of over 10 year of expertise in the distribution of electronic components. Based in Hongkong, we have already established firm and mutual-benefit business relationships with customers from,Europe,America and south Asia,supplying obsolete and hard-to-find components to meet their specific needs.

With the principle of “Quality Parts,Customers Priority,Honest Operation,and Considerate Service”,our business mainly focus on the distribution of electronic components. Line cards we deal with include Microchip,ALPS,ROHM,Xilinx,Pulse,ON,Everlight and Freescale. Main products comprise IC,Modules,Potentiometer,IC Socket,Relay,Connector.Our parts cover such applications as commercial,industrial, and automotives areas.

We are looking forward to setting up business relationship with you and hope to provide you with the best service and solution. Let us make a better world for our industry!



Contact us

Tel: +86-755-8981 8866 Fax: +86-755-8427 6832

Email & Skype: info@chipsmall.com Web: www.chipsmall.com

Address: A1208, Overseas Decoration Building, #122 Zhenhua RD., Futian, Shenzhen, China



DPS-400 SERIES DPH-100 SERIES

Related Information	■ General terms and conditions..... F-17	■ Sensor selection guide P.661~
	■ Glossary of terms P.1373~	■ General precautions..... P.1405



panasonic-electric-works.net/sunx

Thin body controller can do cascade connection and communication with upper devices

Works like a fiber sensor

DPS-400 series accommodates to the requirements for pressure sensors at production site such as miniaturization of sensors for downsizing equipment, convenient shape to fit into machines, and reduction of man-hours when it comes to replacement.

Sensor head DPH-100 series

Direct installation using a hexagonal wrench

- Direct mounting from above
- Installation in narrow spaces
- Extended freedom of layout
- Single axis type free turning structure



Controller DPS-400 series

Thin body (t10 mm t0.394 in) and multi-unit connection on a DIN rail helps to downsize equipment for better construction.



Install on a DIN rail

Current value and threshold value can be checked simultaneously on the dual display

The controller is equipped with a 4-digit dual digital display. Because the threshold value can be adjusted while checking the "current value (current pressure value)", direct setting and checking of the "threshold value" is made smoothly without having to switch screen modes.

Dual display + Direct setting

Thickness
10 mm 0.394 in

Threshold value Current value

Because direct setting is possible

Operation is as easy as analog

“The current value” and “the threshold value” can be checked simultaneously!

- FIBER SENSORS
- LASER SENSORS
- PHOTOELECTRIC SENSORS
- MICRO PHOTOELECTRIC SENSORS
- AREA SENSORS
- LIGHT CURTAINS
- PRESSURE / FLOW SENSORS**
- INDUCTIVE PROXIMITY SENSORS
- PARTICULAR USE SENSORS
- SENSOR OPTIONS
- SIMPLE WIRE-SAVING UNITS
- WIRE-SAVING SYSTEMS
- MEASUREMENT SENSORS
- STATIC CONTROL DEVICES
- ENDOSCOPE
- LASER MARKERS
- PLC / TERMINALS
- HUMAN MACHINE INTERFACES
- ENERGY CONSUMPTION VISUALIZATION COMPONENTS
- FA COMPONENTS
- MACHINE VISION SYSTEMS
- UV CURING SYSTEMS
- Selection Guide
- Pressure/Digital Display
- Pressure/Head-separated
- Flow
- Other Products
- DPC-L100/DPH-L100
- DPS-400/DPH-100**
- DPC-100/DPH-100
- DP5/DPH

Wire-saving, space-saving

The quick-connection cables enable reductions in wiring. The connections and man-hours for the relay terminal block setup can be reduced and valuable space is saved. Also, **DPS-400** series can be connected side-by-side with fiber sensors **FX-300** series or laser sensors **LS** series.

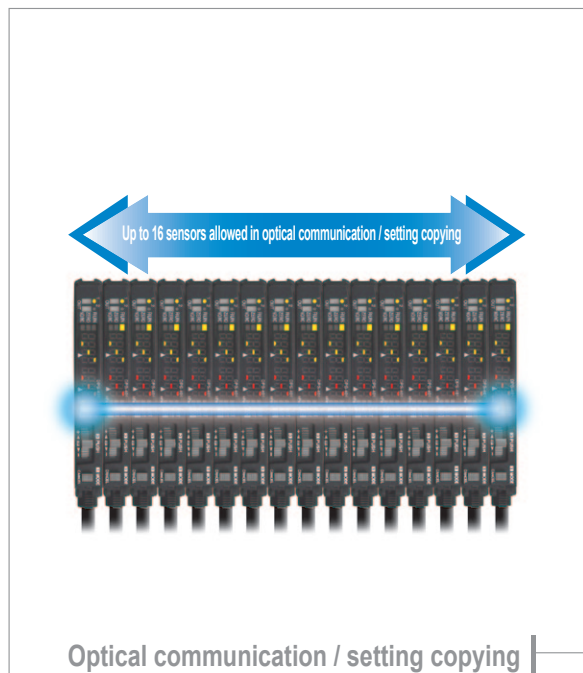
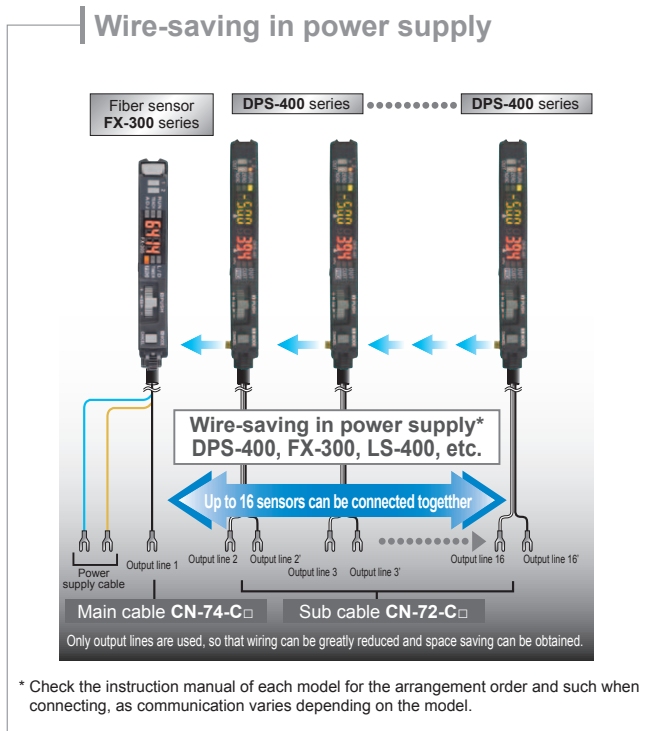

Network communication

Connection to CC-Link open network is possible through the communication unit for CC-Link **SC-GU2-C**. Monitoring or setting changes can be carried out via a PLC, PC, etc.

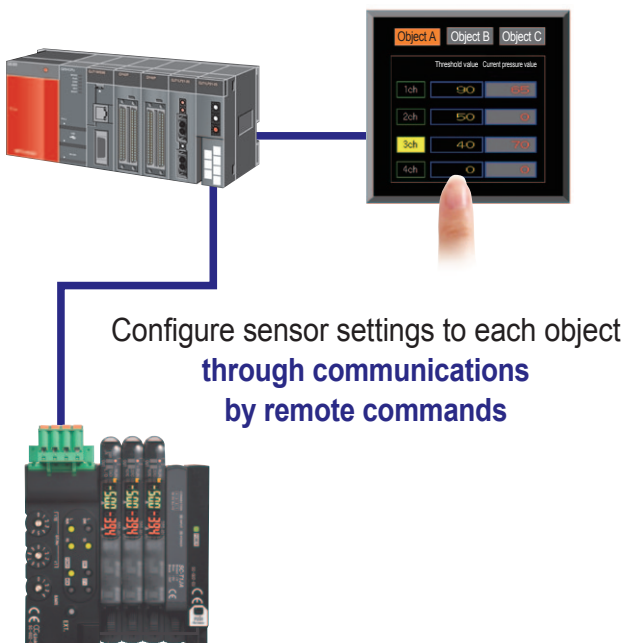

Ultra high-speed response time at 150 μs

Ultra high-speed response time contributes to even greater productivity.

Response time at 150 μs

Independent dual outputs and five output modes equipped

The sensor is equipped with two independent comparative outputs in which separate sensing modes can be selected.

- ① **EASY mode**
This mode is used for comparative output ON / OFF control.
- ② **Hysteresis mode**
This mode is used for setting comparative output hysteresis to the desired level and for carrying out ON / OFF control.
- ③ **Window comparator mode**
This mode is used for setting comparative output ON or OFF at pressures within the setting range.
- ④ **Forced output ON mode**
The comparative outputs are forcibly maintained at ON irrespective of the set values.
- ⑤ **Forced output OFF mode**
The comparative outputs are forcibly maintained at OFF irrespective of the set values.

FIBER SENSORS

LASER SENSORS

PHOTOELECTRIC SENSORS

MICRO PHOTOELECTRIC SENSORS

AREA SENSORS

LIGHT CURTAINS

PRESSURE / FLOW SENSORS

INDUCTIVE PROXIMITY SENSORS

PARTICULAR USE SENSORS

SENSOR OPTIONS

SIMPLE WIRE-SAVING UNITS

WIRE-SAVING SYSTEMS

MEASUREMENT SENSORS

STATIC CONTROL DEVICES

ENDOSCOPE

LASER MARKERS

PLC / TERMINALS

HUMAN MACHINE INTERFACES

ENERGY CONSUMPTION VISUALIZATION COMPONENTS

FA COMPONENTS

MACHINE VISION SYSTEMS

UV CURING SYSTEMS

Selection Guide

Pressure/ Digital Display

Pressure/ Head-separated

Flow

Other Products

DPC-L100/ DPH-L100

DPS-400/ DPH-100

DPC-100/ DPH-100

DP5/DPH

- FIBER SENSORS
- LASER SENSORS
- PHOTOELECTRIC SENSORS
- MICRO PHOTOELECTRIC SENSORS
- AREA SENSORS
- LIGHT CURTAINS
- PRESSURE / FLOW SENSORS**
- INDUCTIVE PROXIMITY SENSORS
- PARTICULAR USE SENSORS
- SENSOR OPTIONS
- SIMPLE WIRE-SAVING UNITS
- WIRE-SAVING SYSTEMS
- MEASUREMENT SENSORS
- STATIC CONTROL DEVICES
- ENDOSCOPE
- LASER MARKERS
- PLC / TERMINALS
- HUMAN MACHINE INTERFACES
- ENERGY CONSUMPTION VISUALIZATION COMPONENTS
- FA COMPONENTS
- MACHINE VISION SYSTEMS
- UV CURING SYSTEMS
- Selection Guide
- Pressure/ Digital Display
- Pressure/ Head-separated
- Flow
- Other Products
- DPC-L100/ DPH-L100
- DPS-400/ DPH-100**
- DPC-100/ DPH-100
- DP5/DPH

Hexagonal wrench installation saves man-hours and spaces

Using a hexagonal wrench, obstructions can be avoided and installation can be done easily by turning the bolt from above.

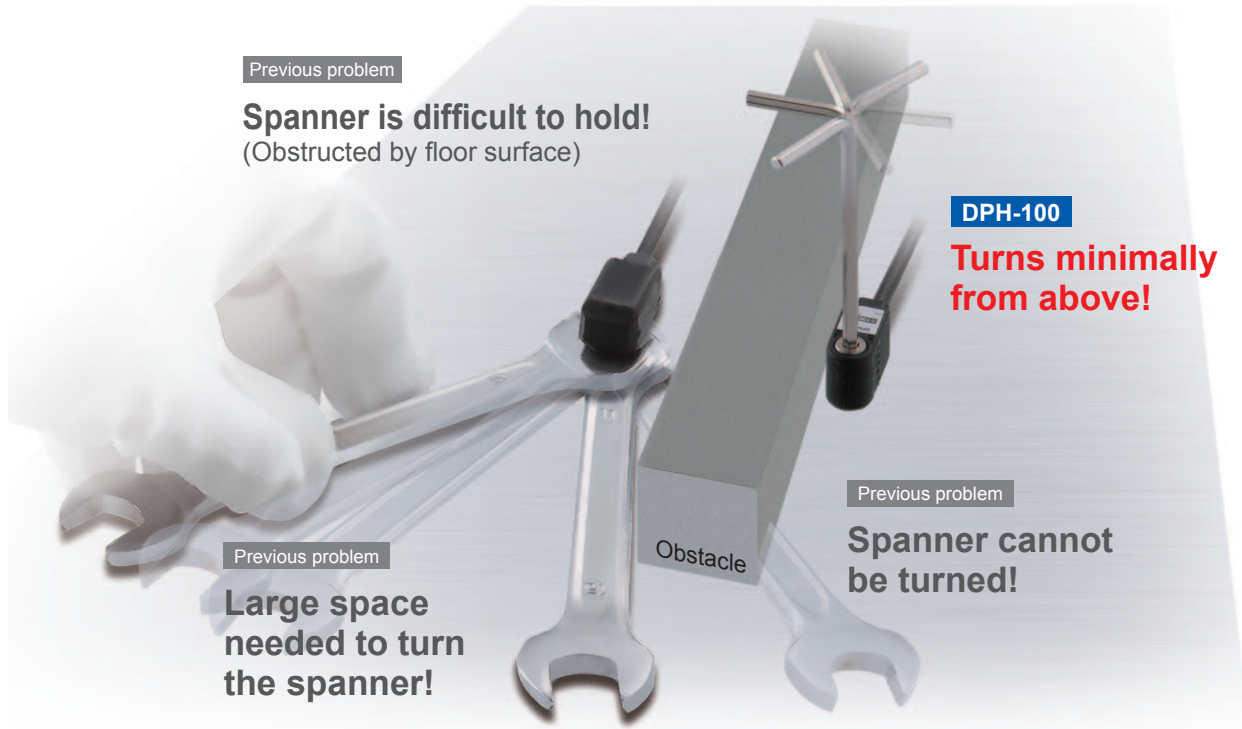

Quick maintenance

During maintenance, the sensor head needed to be removed can be easily removed from directly above.

DPH-100
Remove and install the required sensor head directly.

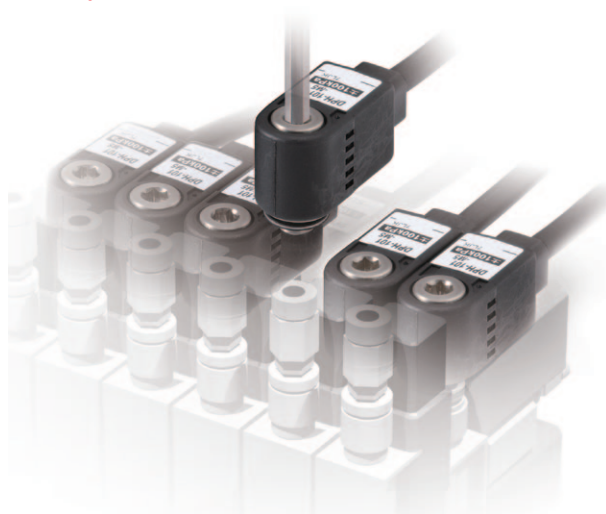

Mounting shape at 14 mm 0.551 in

Because the dead zone caused by the nut is eliminated, the narrowed-down thickness after installation contributes to space saving.

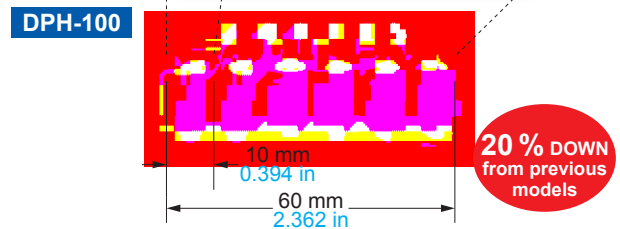
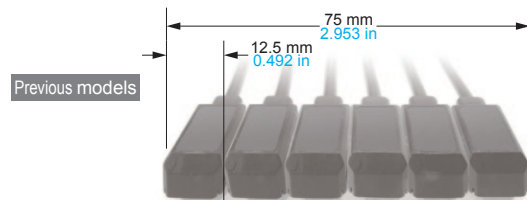
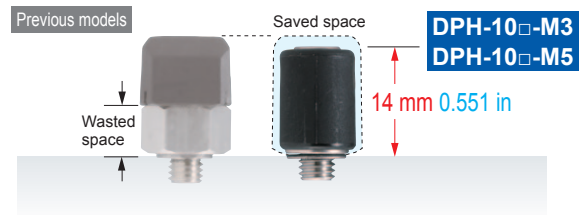

ORDER GUIDE

Controllers

Type	Appearance	Model No.	Applicable sensor head	Output	Connection method
For compound pressure / vacuum pressure		DPS-401	DPH-101 □ DPH-103 □	NPN open-collector transistor two outputs	Use optional quick-connection cable (4-core)
For positive pressure		DPS-402	DPH-102 □		

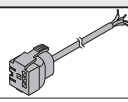
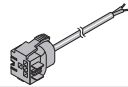

Quick-connection cables Quick-connection cable is not supplied with the controller. Please order it separately.

Type	Appearance	Model No.	Description
Main cable (4-core)		CN-74-C1	Length: 1 m 3.281 ft
		CN-74-C2	Length: 2 m 6.562 ft
		CN-74-C5	Length: 5 m 16.404 ft
Sub cable (2-core)		CN-72-C1	Length: 1 m 3.281 ft
		CN-72-C2	Length: 2 m 6.562 ft
		CN-72-C5	Length: 5 m 16.404 ft

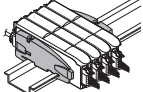
End plates End plates are not supplied with the controller. Please order them separately when the controllers are mounted in cascade.

Appearance	Model No.	Description
	MS-DIN-E	When cascading multiple controllers, or when it moves depending on the way it is installed on a DIN rail, these end plates clamp controllers into place on both sides. Make sure to use end plates when cascading multiple controllers together.

Sensor heads

Type	Appearance	Rated pressure range	Model No.	Pressure port	Applicable fluid
Compound pressure		-100.0 kPa to +100.0 kPa	DPH-101	R1/8 male thread + M5 female thread	Air, non-corrosive gas
			DPH-101-M3	M3 male thread	
			DPH-101-M5	M5 male thread	
Positive pressure		0 to +1.000 MPa	DPH-101-R	R1/8 male thread + M5 female thread	
			DPH-101-M3-R	M3 male thread	
			DPH-101-M5-R	M5 male thread	
Vacuum pressure		0 to -101.0 kPa	DPH-102	R1/8 male thread + M5 female thread	
			DPH-102-M5	M5 male thread	
			DPH-102-M5-R	M5 male thread	
			DPH-103	R1/8 male thread + M5 female thread	
			DPH-103-M3	M3 male thread	
			DPH-103-M5	M5 male thread	
			DPH-103-R	R1/8 male thread + M5 female thread	
			DPH-103-M3-R	M3 male thread	
			DPH-103-M5-R	M5 male thread	

5 m 16.404 ft cable length type

5 m **16.404 ft** cable length type (standard: 2 m **6.562 ft**) is also available. When ordering this type, suffix“-C5” to the Model No. (e.g.) 5 m **16.404 ft** cable length type of **DPH-103-M5-R** is “**DPH-103-M5-R-C5**”

OPTIONS

Designation	Model No.	Description
Controller mounting bracket	MS-DIN-2	Mounting bracket for controller
Controller protection seal	FX-MB1	10 sets of 2 communication window seals and 1 connector seal Communication window seal: It prevents malfunction due to transmission signal from another controller, as well as, prevents effect on another controller. Connector seal: It prevents contact of any metal, etc., with the pins of the quick-connection cable.

Controller mounting bracket

- **MS-DIN-2**

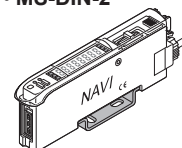

Controller protection seal

- **FX-MB1**

Communication window seal

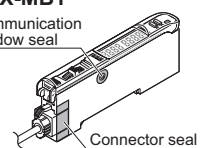

FIBER SENSORS

LASER SENSORS

PHOTO-ELECTRIC SENSORS

MICRO PHOTO-ELECTRIC SENSORS

AREA SENSORS

LIGHT CURTAINS

PRESSURE / FLOW SENSORS

INDUCTIVE PROXIMITY SENSORS

PARTICULAR USE SENSORS

SENSOR OPTIONS

SIMPLE WIRE-SAVING UNITS

WIRE-SAVING SYSTEMS

MEASUREMENT SENSORS

STATIC CONTROL DEVICES

ENDSCOPE

LASER MARKERS

PLC / TERMINALS

HUMAN MACHINE INTERFACES

ENERGY CONSUMPTION VISUALIZATION COMPONENTS

FA COMPONENTS

MACHINE VISION SYSTEMS

UV CURING SYSTEMS

Selection Guide

Pressure/Digital Display

Pressure/Head-separated

Flow

Other Products

DPC-L100/DPH-L100

DPS-400/DPH-100

DPC-100/DPH-100

DP5/DPH

SPECIFICATIONS

Controllers

Type	For compound pressure / vacuum pressure	For positive pressure
Item	DPS-401	DPS-402
Model No.		
Applicable sensor head	Compound pressure : DPH-101 □ Vacuum pressure : DPH-103 □	Positive pressure : DPH-102 □
Rated pressure range	Compound pressure: -100.0 to +100.0 kPa Vacuum pressure: 0 to -101.0 kPa	Positive pressure: 0 to +1.000 MPa
Display / set pressure range	Compound pressure: -199.9 to +199.9 kPa Vacuum pressure: +101.3 to -101.3 kPa	Positive pressure: -1.050 to +1.050 MPa
Supply voltage	12 to 24 V DC ±10 % Ripple P-P 10 % or less	
Power consumption (Note 2)	Normal operation: 650 mW or less (Current consumption 25 mA or less at 24 V supply voltage) ECO mode: 500 mW or less (Current consumption 20 mA or less at 24 V supply voltage)	
Sensor head supply voltage	Same as supply voltage	
Sensor head input	Input voltage range: 1 to 5 V DC (over rated pressure range)	
Comparative outputs (Comparative output 1, 2)	NPN open-collector transistor • Maximum sink current: 50 mA (Note 3) • Applied voltage: 30 V DC or less (between comparative output and 0 V) • Residual voltage: 1.5 V or less (Note 4) [at 50 mA (Note 3) sink current]	
Output operation	NO / NC, selectable by jog switch	
Hysteresis	Minimum 0 digit, variable by hysteresis setting	
Repeatability	With compound pressure type connected: within ±0.2 % F.S. (±4 digits), With vacuum / positive pressure type connected: within ±0.2 % F.S. (±2 digits)	
Response time	150 μs, 500 μs, 1 ms, 5 ms, 10 ms, 50 ms, 100 ms, 500 ms, selectable by jog switch	
Ambient temperature	-10 to +50 °C +14 to +122 °F (cascading 8 to 16 controllers: -10 to +45 °C +14 to +133 °F) (No dew condensation or icing allowed), Storage: -20 to +70 °C -4 to +158 °F	
Ambient humidity	35 to 85 % RH, Storage: 35 to 85 % RH	
Temperature characteristics	Over ambient temperature range -10 to +50 °C +14 to +122 °F : within ±0.5 % F.S. of pressure at +25 °C +77 °F	
Material	Enclosure: Heat-resistant ABS, Protective cover: Polycarbonate, Jog switch: ABS, MODE key: Acrylic	
Weight	20 g approx. (main body only)	

- Notes: 1) Where measurement conditions have not been specified precisely, the conditions used were an ambient temperature of +20 °C **+68 °F**.
 2) Excluding current consumption of the applicable pressure sensor head.
 3) 25 mA max. if 5 or more controllers are connected together.
 4) In case of using the quick-connection cable (cable length: 5 m **16.404 ft**) (optional)
 5) The cable for controller connection is not supplied as an accessory. Make sure to use the quick-connection cables (optional) given below.
 Main cable (4-core): **CN-74-C1** (cable length: 1 m **3.281 ft**), **CN-74-C2** (cable length: 2 m **6.562 ft**), **CN-74-C5** (cable length: 5 m **16.404 ft**)
 Sub cable (2-core): **CN-72-C1** (cable length: 1 m **3.281 ft**), **CN-72-C2** (cable length: 2 m **6.562 ft**), **CN-72-C5** (cable length: 5 m **16.404 ft**)
 6) The values specified above are applied only to the controller.

Sensor heads

Type	Compound pressure	Positive pressure	Vacuum pressure
Item	±100 kPa type	1 MPa type	-101 kPa type
Model No. (Note 3)	DPH-101(-R) DPH-101-M3(-R) DPH-101-M5(-R)	DPH-102 DPH-102-M5(-R)	DPH-103(-R) DPH-103-M3(-R) DPH-103-M5(-R)
Type of pressure	Gauge pressure		
Rated pressure range	-100.0 to +100.0 kPa	0 to +1.000 MPa	0 to -101.0 kPa
Pressure withstandability	500 kPa	1.5 MPa	500 kPa
Applicable fluid	Air, non-corrosive gas		
Supply voltage	12 to 24 V DC ±10 % Ripple P-P 10 % or less		
Current consumption	15 mA or less		
Ambient temperature	0 to +50 °C +32 to +122 °F (No dew condensation allowed), Storage: -10 to +60 °C +14 to +140 °F		
Ambient humidity	35 to 85 % RH, Storage: 35 to 85 % RH		
Temperature characteristics	Over ambient temperature range 0 to +50 °C +32 to +122 °F : within ±2 % F.S. of detected pressure at +25 °C +77 °F		
Material	Front case: PBT, Rear case: PBT (glass fiber reinforced), Pressure port: Stainless steel (SUS303), O-ring: NBR Pressure element: Silicon diaphragm, PPS		
Cable	0.2 mm ² 4-core oil resistant cabtyre cable (Models with "-R" affixed to the Model No. have flexible, oil-resistant cabtyre cable)		
Cable extension	Extension up to total 10 m 32.808 ft is possible with 0.2 mm ² , or more, cable.		
Weight	Net weight	DPH-10 □(-R): Head 10 g approx. / Cable 40 g approx., DPH-10 □-M3/M5(-R): Head 6 g approx. / Cable 40 g approx.	
	Gross weight	DPH-10 □(-R): 80 g approx., DPH-10 □-M3/M5(-R): 70 g approx.	
Accessory	Connector (e-CON): 1 pc. (Note 4)		

- Notes: 1) Where measurement conditions have not been specified precisely, the conditions used were an ambient temperature of +25 °C **+77 °F**.
 2) The sensor head can be used independently.
 3) Model No. having the suffix **"-R"** is flexible cable type.
 4) Connectors (e-CON) are available as spare parts. **CN-EP2**: 5 pcs.

FIBER SENSORS

LASER SENSORS

PHOTO-ELECTRIC SENSORS

MICRO PHOTO-ELECTRIC SENSORS

AREA SENSORS

LIGHT CURTAINS

PRESSURE / FLOW SENSORS

INDUCTIVE PROXIMITY SENSORS

PARTICULAR USE SENSORS

SENSOR OPTIONS

SIMPLE WIRE-SAVING UNITS

WIRE-SAVING SYSTEMS

MEASUREMENT SENSORS

STATIC CONTROL DEVICES

ENDOSCOPE

LASER MARKERS

PLC / TERMINALS

HUMAN MACHINE INTERFACES

ENERGY CONSUMPTION VISUALIZATION COMPONENTS

FA COMPONENTS

MACHINE VISION SYSTEMS

UV CURING SYSTEMS

Selection Guide

Pressure/ Digital Display

Pressure/ Head-separated

Flow

Other Products

DPC-L100/ DPH-L100

DPS-400/ DPH-100

DPC-100/ DPH-100

DP5/ DPH

I/O CIRCUIT AND WIRING DIAGRAMS

I/O circuit diagram

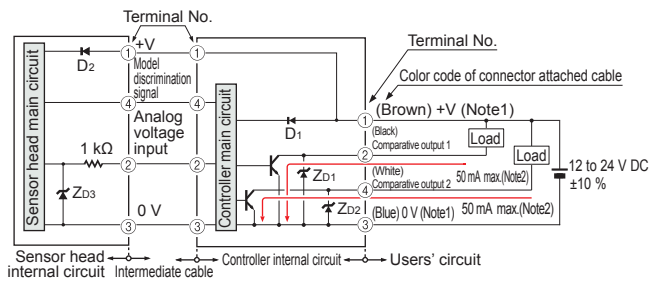

- Notes: 1) The quick-connection sub cable does not have +V (brown) and 0 V (blue). The power is supplied from the connector of the main cable.
 2) 25 mA max. if 5 or more controllers are connected together.
 3) Do not use the controllers in a series (AND) connection.

Symbols ... D1, D2 : Reverse supply polarity protection diode
 ZD1 to ZD3 : Surge absorption zener diode

Quick-connection cable side terminal arrangement diagram

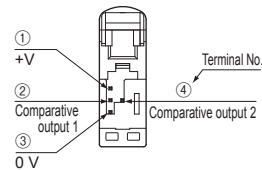

Sensor head side terminal arrangement diagram

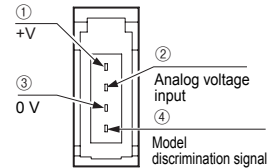

PRECAUTIONS FOR PROPER USE

Refer to General precautions.



- Never use this product as a sensing device for personnel protection.
- In case of using sensing devices for personnel protection, use products which meet laws and standards, such as OSHA, ANSI or IEC etc., for personnel protection applicable in each region or country.
- The **DPH-100** series is designed for use with air and non-corrosive gas. It cannot be used with liquid or corrosive and inflammable gases.

Wiring

- Make sure to use the optional quick-connection cable for the connection of the controller. Extension up to total 50 m **164.042 ft** (cascading 9 to 16 controllers: 20 m **65.617 ft**) is possible with 0.3 mm², or more, cable. However, in order to reduce noise, make the wiring as short as possible.

Others

- This product has been developed / produced for industrial use only.
- Use within the rated pressure range.
- Do not use during the initial transient time (controller: 1 sec. approx., sensor head: 50 ms approx.) after the power supply is switched on.
- Do not apply pressure exceeding the pressure withstandability value. The diaphragm will get damaged and correct operation shall not be maintained.
- Do not insert wires, etc., into the pressure port. The diaphragm will get damaged and correct operation shall not be maintained.

FIBER SENSORS

LASER SENSORS

PHOTO-ELECTRIC SENSORS

MICRO PHOTO-ELECTRIC SENSORS

AREA SENSORS

LIGHT CURTAINS

PRESSURE / FLOW SENSORS

INDUCTIVE PROXIMITY SENSORS

PARTICULAR USE SENSORS

SENSOR OPTIONS

SIMPLE WIRE-SAVING UNITS

WIRE-SAVING SYSTEMS

MEASUREMENT SENSORS

STATIC CONTROL DEVICES

ENDSCOPE

LASER MARKERS

PLC / TERMINALS

HUMAN MACHINE INTERFACES

ENERGY CONSUMPTION VISUALIZATION COMPONENTS

FA COMPONENTS

MACHINE VISION SYSTEMS

UV CURING SYSTEMS

Selection Guide

Pressure/Digital Display

Pressure/Head-separated

Flow

Other Products

DPC-L100/DPH-L100

DPS-400/DPH-100

DPC-100/DPH-100

DP5/DPH

DIMENSIONS (Unit: mm in)

The CAD data in the dimensions can be downloaded from our website.

DPS-401 DPS-402 Controller

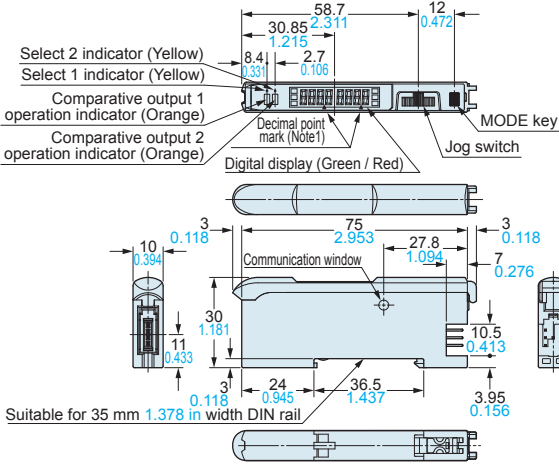

Note: Decimal points for pressure value. Above figure shows the **DPS-401** (compound pressure / vacuum pressure). Positions of display and the pressure unit on the name plate for **DPS-402** (positive pressure) differ from the above figure.

MS-DIN-E End plate (Optional)

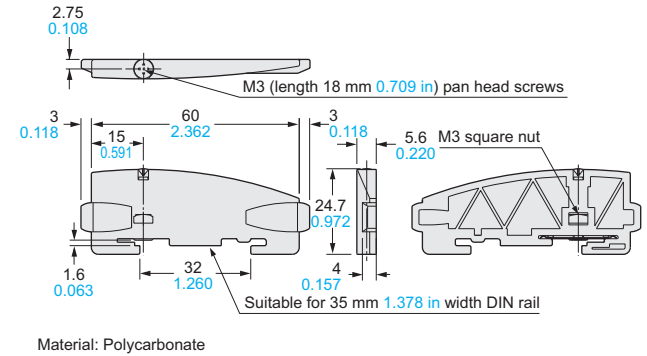

CN-74-C1 CN-74-C2 CN-74-C5 Main cable (Optional)

• Length L

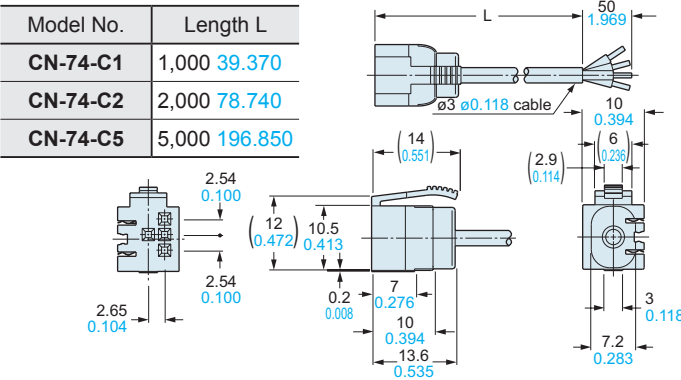

CN-72-C1 CN-72-C2 CN-72-C5 Sub cable (Optional)

• Length L

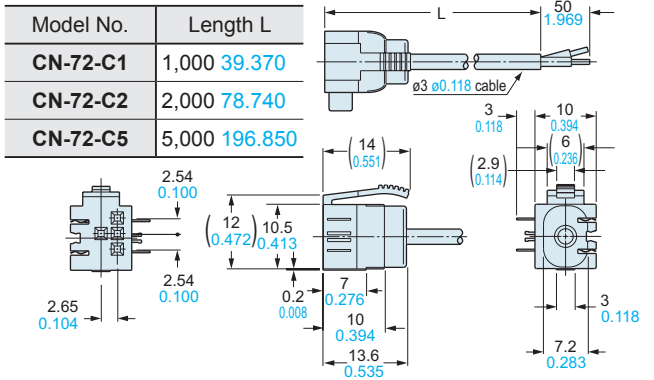

DPH-10□(-R) Sensor head

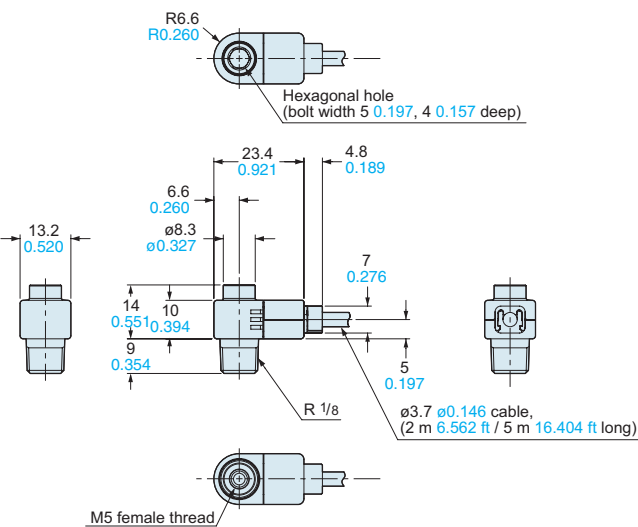

DPH-10□-M3(-R) DPH-10□-M5(-R) Sensor head

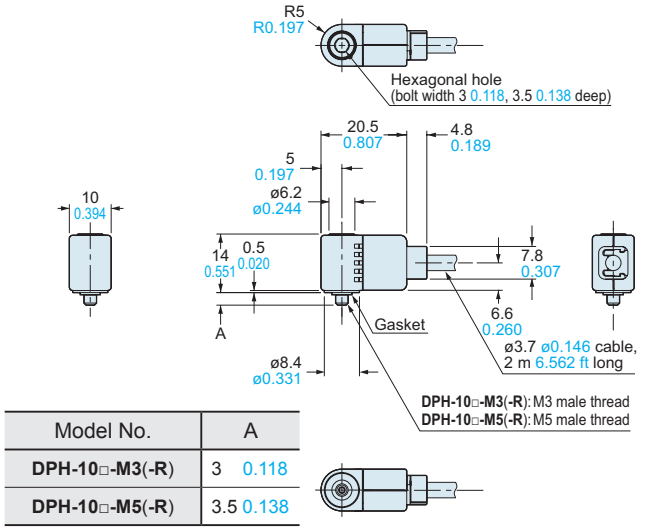

Selection Guide

- Pressure/Digital Display
- Pressure/Head-separated
- Flow
- Other Products
- DPC-L100/DPH-L100
- DPS-400/DPH-100**
- DPC-100/DPH-100
- DP5/DPH

DIMENSIONS (Unit: mm in)

The CAD data in the dimensions can be downloaded from our website.

MS-DIN-2 Controller mounting bracket (Optional)

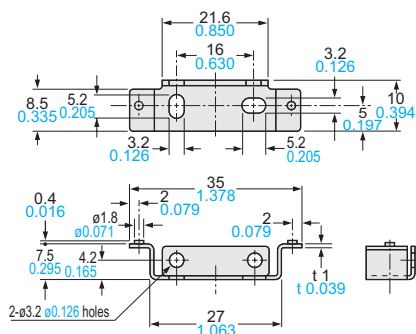

Material: Cold rolled carbon steel (SPCC) (Uni-chrome plated)

FIBER SENSORS

LASER SENSORS

PHOTO-ELECTRIC SENSORS

MICRO PHOTO-ELECTRIC SENSORS

AREA SENSORS

LIGHT CURTAINS

PRESSURE / FLOW SENSORS

INDUCTIVE PROXIMITY SENSORS

PARTICULAR USE SENSORS

SENSOR OPTIONS

SIMPLE WIRE-SAVING UNITS

WIRE-SAVING SYSTEMS

MEASURE-MENT SENSORS

STATIC CONTROL DEVICES

ENDOSCOPE

LASER MARKERS

PLC / TERMINALS

HUMAN MACHINE INTERFACES

ENERGY CONSUMPTION VISUALIZATION COMPONENTS

FA COMPONENTS

MACHINE VISION SYSTEMS

UV CURING SYSTEMS

Selection Guide

Pressure/ Digital Display

Pressure/ Head-separated

Flow

Other Products

DPC-L100/ DPH-L100

DPS-400/ DPH-100

DPC-100/ DPH-100

DP5/ DPH