



Chipsmall Limited consists of a professional team with an average of over 10 year of expertise in the distribution of electronic components. Based in Hongkong, we have already established firm and mutual-benefit business relationships with customers from,Europe,America and south Asia,supplying obsolete and hard-to-find components to meet their specific needs.

With the principle of "Quality Parts,Customers Priority,Honest Operation,and Considerate Service",our business mainly focus on the distribution of electronic components. Line cards we deal with include Microchip,ALPS,ROHM,Xilinx,Pulse,ON,Everlight and Freescale. Main products comprise IC,Modules,Potentiometer,IC Socket,Relay,Connector.Our parts cover such applications as commercial,industrial, and automotives areas.

We are looking forward to setting up business relationship with you and hope to provide you with the best service and solution. Let us make a better world for our industry!



Contact us

Tel: +86-755-8981 8866 Fax: +86-755-8427 6832

Email & Skype: info@chipsmall.com Web: www.chipsmall.com

Address: A1208, Overseas Decoration Building, #122 Zhenhua RD., Futian, Shenzhen, China





Multilayer Diplexer

For 824-960MHz / 1710-2170MHz

DPX202170DT-4149A1

2.0x1.25mm [EIA 0805]*

* Dimensions Code JIS[EIA]

Multilayer Diplexer

Conformity to RoHS Directive

For 824-960MHz / 1710-2170MHz

DPX202170DT-4149A1

SHAPES AND DIMENSIONS

[Top view]

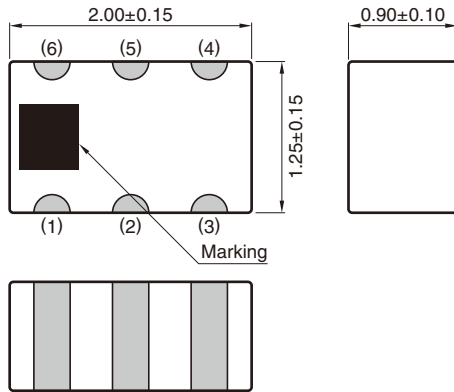

[Bottom view]

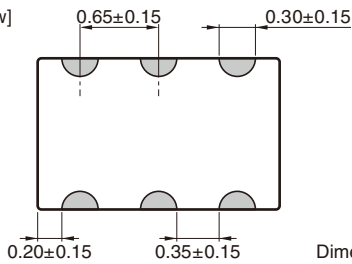

Terminal functions

| | |
|---|-----------|
| 1 | GND |
| 2 | Common |
| 3 | GND |
| 4 | Low-band |
| 5 | GND |
| 6 | High-band |

RECOMMENDED LAND PATTERN

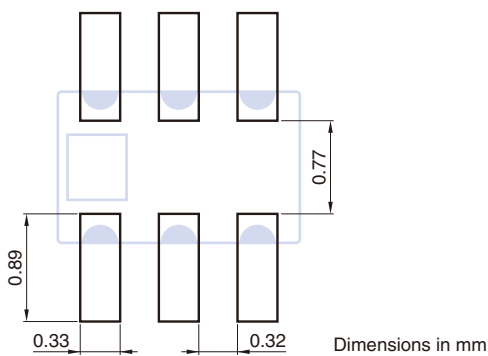

EVALUATION BOARD

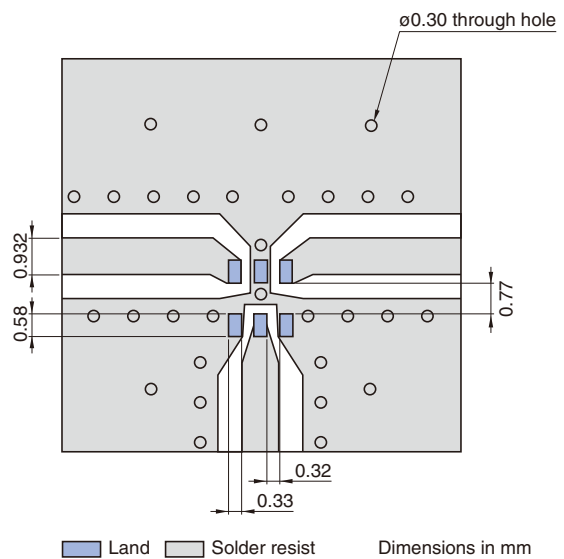

Line width should be designed to match 50Ω characteristic impedance, depending on PCB material and thickness.

RoHS Directive Compliant Product: See the following for more details related to RoHS Directive compliant products. <http://product.tdk.com/en/environment/rohs/>

- All specifications are subject to change without notice.
- Before using these products, be sure to request the delivery specifications.

DPX202170DT-4149A1

ELECTRICAL CHARACTERISTICS

LOW-BAND

| Item | Frequency Range (MHz) | Min. | Typ. | Max. |
|---------------------------------------|-----------------------|-------|--------------|------|
| Insertion Loss (dB) | 824 to 960 | — | 0.24 | 0.30 |
| Return Loss (dB) | 824 to 960 | 13.98 | 19.7 | — |
| Attenuation (dB) | 1710 to 2170 | 15 | 17.7 | — |
| Characteristic Impedance (Ω) | | | 50 (Nominal) | |

· Ta: +25±5°C

HIGH-BAND

| Item | Frequency Range (MHz) | Min. | Typ. | Max. |
|---------------------------------------|-----------------------|-------|--------------|------|
| Insertion Loss (dB) | 1710 to 2170 | — | 0.38 | 0.50 |
| Return Loss (dB) | 1710 to 2170 | 11.73 | 13.8 | — |
| Attenuation (dB) | 824 to 960 | 20 | 22.8 | — |
| Characteristic Impedance (Ω) | | | 50 (Nominal) | |

· Ta: +25±5°C

COMMON

| Item | Frequency Range (MHz) | Min. | Typ. | Max. |
|---------------------------------------|-----------------------|-------|--------------|------|
| Return Loss (dB) | 824 to 960 | 13.98 | 19.4 | — |
| | 1710 to 2170 | 11.73 | 13.6 | — |
| Characteristic Impedance (Ω) | | | 50 (Nominal) | |

· Ta: +25±5°C

TEMPERATURE RANGE

| Operating temperature (°C) | Storage temperature (°C) |
|----------------------------|--------------------------|
| -40 to +85 | -40 to +85 |

- All specifications are subject to change without notice.
- Before using these products, be sure to request the delivery specifications.

DPX202170DT-4149A1

FREQUENCY CHARACTERISTICS

LOW-BAND

Insertion Loss

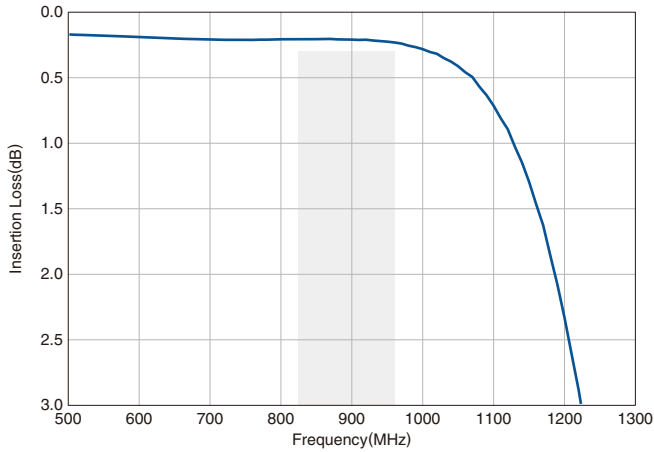

Return Loss

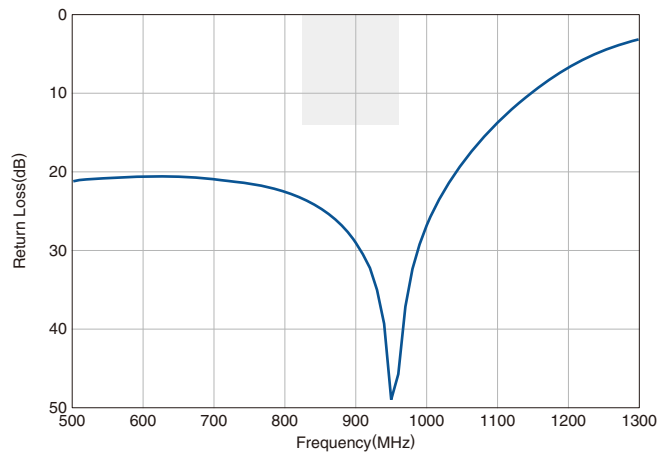

Attenuation

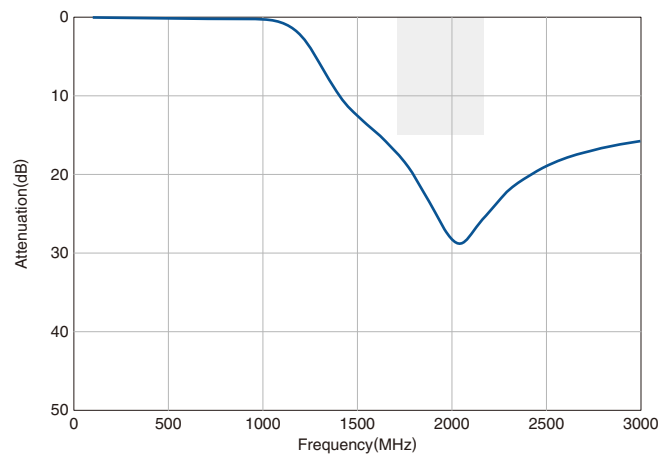

HIGH-BAND

Insertion Loss

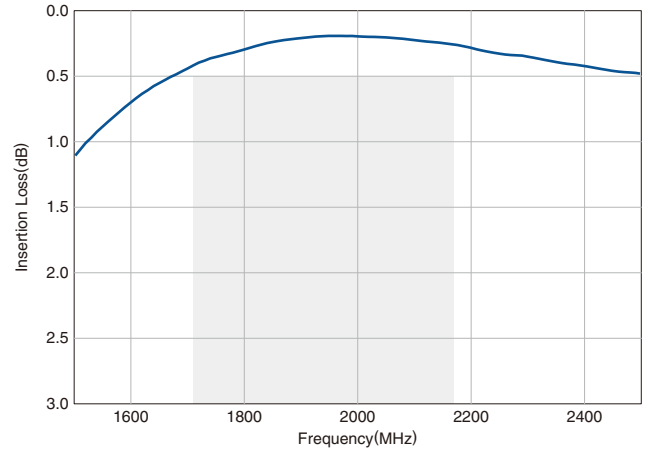

Return Loss

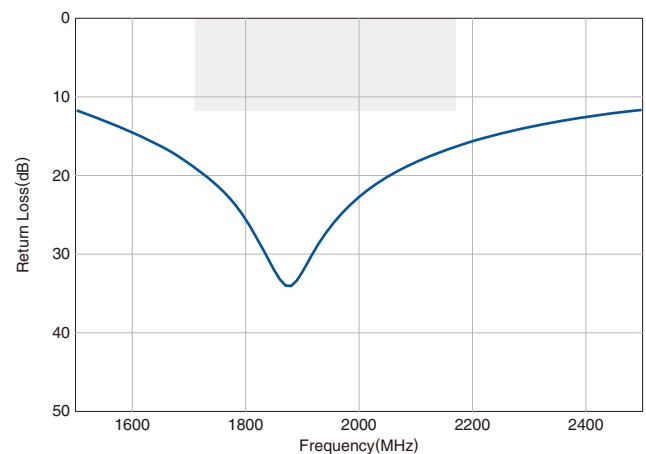

Attenuation

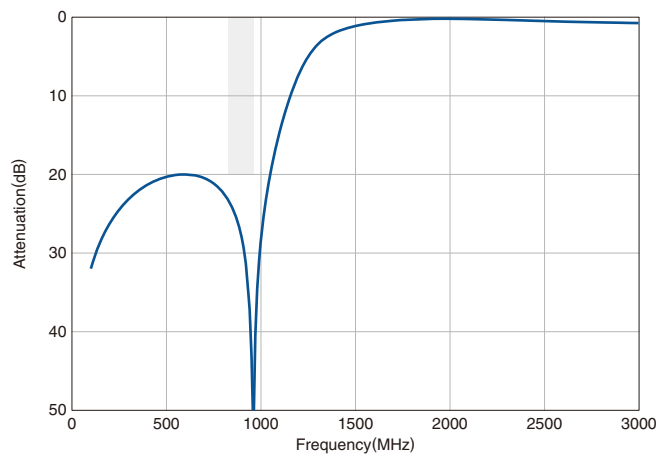

- All specifications are subject to change without notice.
- Before using these products, be sure to request the delivery specifications.

DPX202170DT-4149A1

FREQUENCY CHARACTERISTICS

COMMON

Return Loss

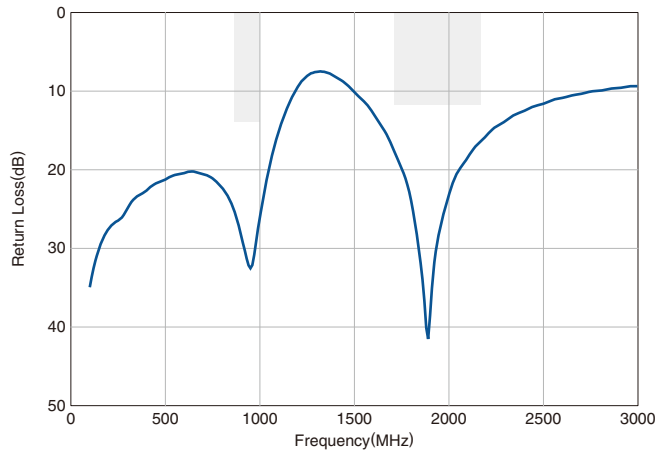

Isolation

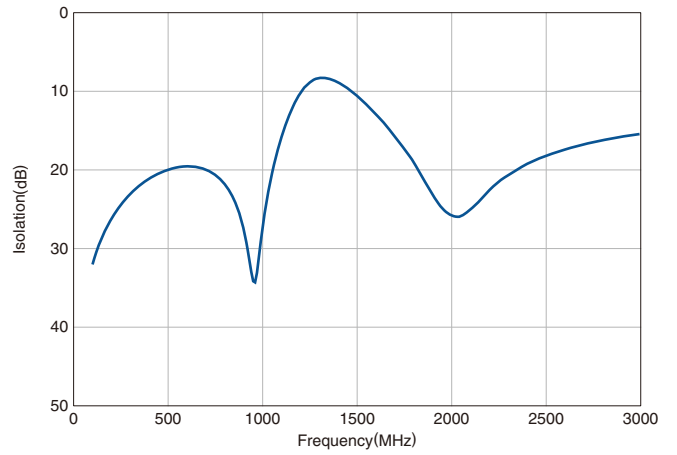

- All specifications are subject to change without notice.
- Before using these products, be sure to request the delivery specifications.

DPX202170DT-4149A1

RECOMMENDED REFLOW PROFILE

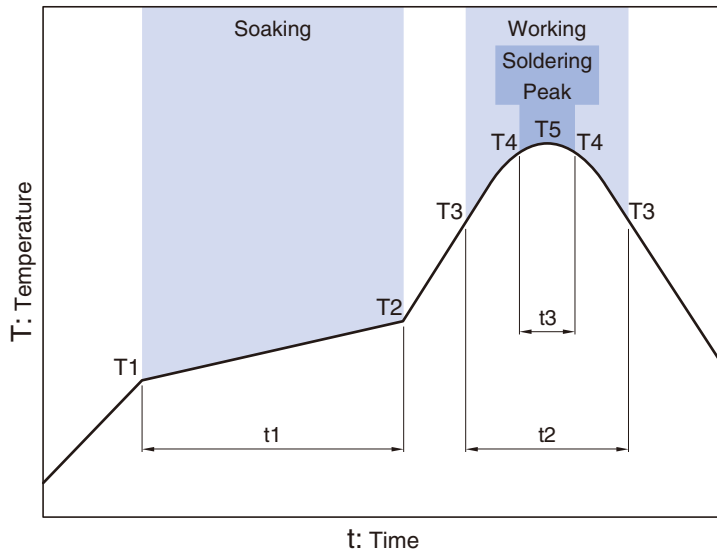

| Soaking | | | Working | | Soldering Peak | | |
|---------|-------|------------|---------|---------------|----------------|------------|------------|
| Temp. | Temp. | Time | Temp. | Time | Temp. | Time | Temp. |
| T1 | T2 | t1 | T3 | t2 | T4 | t3 | T5 |
| 150°C | 180°C | 60 to 120s | 230°C | more than 30s | 247 to 253°C | within 10s | 260°C max. |

- All specifications are subject to change without notice.
- Before using these products, be sure to request the delivery specifications.

REMINDERS FOR USING THESE PRODUCTS

Before using these products, be sure to request the delivery specifications.

SAFETY REMINDERS

Please pay sufficient attention to the warnings for safe designing when using these products.

REMINDERS

The products listed on this catalog are intended for use in general electronic equipment (AV equipment, telecommunications equipment, home appliances, amusement equipment, computer equipment, personal equipment, office equipment, measurement equipment, industrial robots) under a normal operation and use condition.

The products are not designed or warranted to meet the requirements of the applications listed below, whose performance and/or quality require a more stringent level of safety or reliability, or whose failure, malfunction or trouble could cause serious damage to society, person or property.

Please understand that we are not responsible for any damage or liability caused by use of the products in any of the applications below or for any other use exceeding the range or conditions set forth in this catalog.

- | | |
|---|--|
| (1) Aerospace/Aviation equipment | (8) Public information-processing equipment |
| (2) Transportation equipment (cars, electric trains, ships, etc.) | (9) Military equipment |
| (3) Medical equipment | (10) Electric heating apparatus, burning equipment |
| (4) Power-generation control equipment | (11) Disaster prevention/crime prevention equipment |
| (5) Atomic energy-related equipment | (12) Safety equipment |
| (6) Seabed equipment | (13) Other applications that are not considered general-purpose applications |
| (7) Transportation control equipment | |

When using this product in general-purpose applications, you are kindly requested to take into consideration securing protection circuit/equipment or providing backup circuits, etc., to ensure higher safety.