



Chipsmall Limited consists of a professional team with an average of over 10 year of expertise in the distribution of electronic components. Based in Hongkong, we have already established firm and mutual-benefit business relationships with customers from,Europe,America and south Asia,supplying obsolete and hard-to-find components to meet their specific needs.

With the principle of “Quality Parts,Customers Priority,Honest Operation,and Considerate Service”,our business mainly focus on the distribution of electronic components. Line cards we deal with include Microchip,ALPS,ROHM,Xilinx,Pulse,ON,Everlight and Freescale. Main products comprise IC,Modules,Potentiometer,IC Socket,Relay,Connector.Our parts cover such applications as commercial,industrial, and automotives areas.

We are looking forward to setting up business relationship with you and hope to provide you with the best service and solution. Let us make a better world for our industry!



Contact us

Tel: +86-755-8981 8866 Fax: +86-755-8427 6832

Email & Skype: info@chipsmall.com Web: www.chipsmall.com

Address: A1208, Overseas Decoration Building, #122 Zhenhua RD., Futian, Shenzhen, China



cannon

Rack & Panel Connectors Catalog



ITT

ENGINEERED FOR LIFE

Amazing things happen

When great things connect

ITT Cannon is a leading global manufacturer of connector products serving international customers in the aerospace and defense, industrial and medical end markets.

Whether delivering critical specs to aircraft pilots, streaming data through communications satellites or enabling ultrasound equipment to give expectant parents a first look at their unborn child, ITT Cannon connects the world's most important information to the people who need it.



More than a Century of Connections

Since 1915, Cannon products have been used in a history of "firsts." From the first "talking" movie to the first man on the moon, Cannon has set the standard for reliable, harsh environment interconnect solutions." Today we proudly continue our legacy of innovation with a goal to connect the world and inspire the successes of the next century—because amazing things happen when great things connect.

Visit ittcannon.com to learn more.

About ITT

ITT is a diversified leading manufacturer of highly engineered critical components and customized technology solutions for the energy, transportation and industrial markets. Building on its heritage of innovation, ITT partners with its customers to deliver enduring solutions to the key industries that underpin our modern way of life. Founded in 1920, ITT is headquartered in White Plains, N.Y., with employees in more than 35 countries and sales in a total of approximately 125 countries.

For more information visit itt.com



Commercial Aerospace



Military & Defense



Medical



Industrial

ITT Cannon's connector portfolio

is one of the most extensive in the industry, offering customers a range of off-the-shelf and customized interconnect solutions for multiple markets and applications. Visit ittcannon.com to learn more.

Table of contents

ITT Cannon Brand Overview 2

Introduction: Rack & Panel Connectors 5

BKA ARINC 600..... 6

BKA ARINC 600 with ARINC 801 Inserts 11

SGA (Single Gang ARINC 600)..... 23

DPXMA/ME (ARINC 404)..... 29

DPXNA/DPXNE 44

BKA & DPX Contacts 61

DPK (83733-Style) 79

DPA 97

DPGM/DPJM/DPJMB 102

DPD/DPDMA 110

About ITT Cannon..... 122

Product Safety Information..... 123

Meet Some of Our Most Popular Connectors..... 124

Introduction: Rack & Panel Connector Solutions

Designed for exceptional performance in harsh environments, ITT Cannon's Rack & Panel interconnect solutions are manufactured to the highest quality and reliability standards for the aerospace & defense industry. At ITT Cannon, our legacy of innovation and expertise in the design and engineering of Rack & Panel connectors has established industry and competitive benchmarks for decades. From our environment-resistant DPK interconnect, which was designed into nearly every U.S. space flight and mission flown during the 1960s, to the groundbreaking expansion of Rack & Panel Connectors with the introduction of our innovative BKAD/E Series in the 1970s, ITT Cannon has achieved significant milestones.

Today, we are recognized as an industry leader in rectangular Rack & Panel interconnect solutions, offering an unparalleled range of off-the-shelf and custom products to align with customer needs. Our latest is the BKA ARINC 600 Rack & Panel with ARINC 801 ASR, an integral part of our end-to-end ARINC 801 Fiber Optic Series for commercial and military aviation. Now and in the future, we remain committed to manufacturing the most reliable, high performance and cost-effective Rack & Panel connectors available to meet the demands of a dynamic marketplace. Because at ITT Cannon, amazing things happen when great things connect.

Learn more about our world-class manufacturing processes, facilities and RoHS compliance on page 121 or visit ittcannon.com

Our tradition of engineering excellence continues with the **BKA Rack & Panel Connector with ARINC 801 ASR**. Designed for use in harsh environment applications that require quick and accurate data transfer such as In-Flight Entertainment/Connectivity, this innovative fiber optic interconnect solution supports transmission speeds of 10 gigabits/sec (Gb/S) or more. Built for optimum performance in the most extreme conditions, the BKA Rack & Panel Connector with ARINC 801 ASR delivers signals, video and data when it matters most. See page 11 for more details or visit ittcannon.com



	BKAD/E/F ARINC 600	SGA ARINC 600	DPX ARINC 404	DPXNE/NA AS81659	DPK 83733-Style	DPA
Type	Plug and Socket					
Current Rating	see ARINC 600		AS39029			
Contact Resistance	AS39029					
Contact Material	AS39029					
Shell	see ARINC 600		Various	AS81659	83733-Style	
Shell Material	Aluminum Alloy					

Dimensions shown in inches (mm)
Specifications and dimensions subject to change

BJA (ARINC 600)

Product Overview

BJA connectors represent the standard for Avionic systems developed to support the Air Transportation market. They are blind mate connectors designed per ARINC 600. These connectors are available in 3 and 6 gang configurations and can accommodate up to 800 low insertion force contacts. The inserts are field replaceable. BJA connectors are available in environmental and non-environmental versions.



BKAC	BKAD/E	BKAF/X
<p>Rear Release/Rear Removable Size 12, 16, 20, 22 Crimp Contacts</p> <p>BKAC is a combination of BKAD (no environmental O-ring) with inserts not potted into the shell. BKAE in which dielectric inserts have a wire seal in the grommet on the rear surface.</p>	<p>Rear Release/Rear Removable Size 12, 16, 20, 22 Crimp Contacts</p> <p>BKAD/E connectors represent the standard for new avionic systems developed to support the air transportation market. Several important design concerns have been addressed and solved in this new series. High mating forces of pluggable modules in a rack have been reduced by approximately two-thirds.</p> <p>The low insertion force contacts are also interchangeable with the contacts used in the DPX series and permit retrofit of existing equipment.</p>	<p>Front Release/Front Removable Size 22 Solder Tail and Wrap Post Contacts</p> <p>This new connector is totally intermateable and intermountable with ARINC 600 connectors now in the field.</p> <p>The BKAF permits the user to easily replace a contact in case of problems, rather than disassemble the entire connector--it is available with size 22 contacts in wrap post or solder-tail versions. The system maintains the advantages of low insertion force technology incorporated in all ARINC 600 connectors.</p> <p>BKAX contacts are front release and front removable</p>

- Low insertion force contacts
- Both environmental and non- environmental versions
- Polarizing posts that are removable from the mating face
- Field replaceable inserts for size 22 and power contacts
- Up to 800 size 22 contacts in one connector
- Crimp, coax, power, printed circuit and wire wrapable post style contacts
- Uses standard DPX crimp, insertion/extraction tooling
- Waveguide connections available

Dimensions shown in inches (mm)
Specifications and dimensions subject to change

BA (ARINC 600)

Product Overview (continued)

Performance and Material Specifications

		BKAD	BKAE/C	BKAF/X	Specifications
Shell & Waveguide	Material	Aluminum alloy			QQ A-591/A380
	Finish	Alodine 1200			MIL-C-5541
Insulator	Material	Thermoset			N/A
Contacts	Material	Copper alloy			QQ-C-533
	Finish	Gold over Nickel			MIL-G-45204
	Termination	Crimp		P.C./Wrap Post	N/A
Grommets & Seals	Material	N/A	Silicone-based Elastomer	N/A	
O-Ring	Material				

Electrical Data

Contact Size	Wire Size	Insulation O.D. Limits (Inch) Max.	Max. Current for Tests (Amps) per AS39029 and ARINC 600	Max. Potential Drop (Millivolts) at 25°C
12	12	.135 (3.43)	23.0	60
	14		17.0	60
16	16	.103 (2.62)	13.0	65
	20		7.5	55
20	20	.071 (1.80)	7.5	65
	22		5.0	55
	24		3.0	45
22	22	.054 (1.37)	5.0	55
	24		3.0	45
	26		2.0	40

BJA (ARINC 600)

How to Order

Product	BJA (Per ARINC 600)												
	BKA	R	D	2	-	A234	M	-	3	00	01*	-	F0
RoHS Version: (Optional)	R -	RoHS Compliant Finish: Trivalent Chromate											
Class:	C -	Same as E, except uses BKAD shells and Less O-rings on plug side											
	D -	Non-Environmental (rear release, crimp contacts)											
	E -	Environmental (rear release, crimp contacts)											
	F -	Receptacle only - Non-environmental (front release, solder and wrap post #22 contact, all others are rear release)											
	PF -	Plug only - Non-environmental (front release, solder and wrap post #22 contact, all others are rear release)											
	T -	Non-environmental connector using filtered contacts. See ITT Filter Connector catalog for further details. (Reference only)											
	X -	Receptacle only - All contacts are front release, for PCB Applications only											
	PX -	Plug only - All contacts are front release, for PCB Applications only											
Shell Size:	1 -	Max. contact capacity - 125				ARINC 600 Original Mating Forces							
	2 -	Max. contact capacity - 400				27 lbs *							
	3 -	Max. contact capacity - 800				60 lbs *							
Connector Layout Description:	See Pages 12-16 for Connector Layouts												
Size 1 Coax Insert Modifier:	M -	Connector contains modified 71W1 or 2W2 insert (four Mounting screw hole locations and coaxial contact used in this insert are interchangeable between other manufacturers)											
Shell Style:	3 -	Plug (Rack side)											
	4 -	Receptacle (Box side)											
Connector Mounting Modifier:	See Page 9 for Connector Mounting Modifiers												
Polarizing Position:	01 -	See Polarization chart on Page 22 for Position 01 through 216 (per ARINC 600)											
	00 -	00 for polarization indicates that polarizing hardware is not supplied (i.e., BKAD2-313-30000) Blank or no position indicated means - Polarizing posts or keys not installed but supplied with connector (i.e., BKAD2-313-300)											
Modifier (Contact, Finish, Material):	F0 -	See Page 10 for Modifiers (Contact, Finish, Material)											

ANY OTHER COMBINATION OF INSERTS WITHIN A SPECIFIC SHELL IS AVAILABLE UPON REQUEST: For additional layouts, consult your account representative.

Dimensions shown in inches (mm)
Specifications and dimensions subject to change

BJA (ARINC 600)

How to Order (continued)

Connector Mounting Modifier

00 -	PLUG AND RECEPTACLE CONNECTORS .148 dia. connector mounting holes. This is a Standard Configuration.	47 -	PLUG AND RECEPTACLE CONNECTORS Surtec 650V Plating-With #4 (.112) - 40 ESNA clinch nuts
01 -	PLUG AND RECEPTACLE CONNECTORS With #6 (.138) - 32 ESNA clinch nuts (See Table for quantities)	48 -	PLUG AND RECEPTACLE CONNECTORS Electroless Nickel plated shells with 4-40 clinch nuts in all connector mounting holes (See Table for quantities)
02 -	SIZE 1 RECEPTACLE CONNECTORS ONLY Standard Configuration with three PWB mounting lugs machined off.	50 -	PLUG CONNECTORS ONLY-SIZE 1 ONLY Standard Configuration with .0008-.0012 thick nickel plated die cast shell and EMI springs.
03 -	PLUG AND RECEPTACLE CONNECTORS With #4 (.112) - 40 ESNA clinch nuts (See Table for quantities)	51 -	PLUG CONNECTORS ONLY-SIZE 1 ONLY Standard Configuration with .0008-.0012 thick nickel plated die cast shell and EMI springs and all holes with #6-32 clinch nuts
04 -	SIZE 1 RECEPTACLE CONNECTORS ONLY With four #6 (.138) - 32 ESNA clinch nuts. Modified shell - three PWB mounting lugs machined off and O/A length of flange shortened to 6.980. (See Table for quantities)	52 -	PLUG CONNECTORS ONLY-SIZE 2 AND 3 ONLY Standard Configuration with .0008-.0012 thick nickel plated die cast shell and EMI springs and #6-32 clinch nuts in all places.
06 -	SIZE1 PLUG CONNECTOR ONLY With #6 (.138) - 32 ESNA clinch nuts (See Table for quantities) and with side mounting lugs machined off. (See Table for quantities)	53 -	PLUG CONNECTORS ONLY-SIZE 2 AND 3 ONLY Standard Configuration with .0008-.0012 thick nickel plated die cast shell and EMI springs and #6-32 clinch nuts except in center holes.
08 -	SIZE 2 AND 3 PLUG AND RECEPTACLE CONNECTORS ONLY With #4 (.112) - 40 ESNA clinch nuts in all connector mounting holes (See Table for quantities)	54 -	PLUG CONNECTORS ONLY-SIZE 2 AND 3 ONLY Standard Configuration with .0008-.0012 thick nickel plated die cast shell and EMI springs with #6-32 clinch nuts (4 places).
09 -	SIZE 2 AND 3 PLUG AND RECEPTACLE CONNECTORS ONLY With #6 (.138) - 32 ESNA clinch nuts in all connector mounting holes (See Table for quantities)	55 -	PLUG CONNECTORS ONLY-SIZE 2 AND 3 ONLY Standard Configuration with .0008-.0012 thick nickel plated die cast shell and EMI springs and all holes with #6-32 clinch nuts (6 places).
22 -	PLUG CONNECTORS ONLY Standard Configuration with .0008-.0012 thick nickel plated shell. The shell is provided with an EMI/Grounding spring. Metallic inserts, if supplied, are selectively plated - I.D. Silver; O.D. Nickel over Silver. The contact retaining/grounding clips are gold plated.	56 -	PLUG CONNECTORS ONLY-SIZE 2 AND 3 ONLY Standard Configuration with .0008-.0012 thick nickel plated die cast shell and EMI springs and #4-40 clinch nuts in all places.
23 -	PLUG AND RECEPTACLE CONNECTORS With floating eyelets (.048 min. radial float) in four corner connector mounting holes.	57 -	PLUG CONNECTORS ONLY-SIZE 2 AND 3 ONLY Standard Configuration with .0008-.0012 thick nickel plated die cast shell and EMI springs and #6-32 clinch nuts (8 places no center hole clinch nuts).
25 -	RECEPTACLE CONNECTORS ONLY 01 mod with #6 (.138) - 32 ESNA clinch nuts and .0008-.0012 thick nickel plated shell. (See Table for quantities)	58 -	PLUG CONNECTORS ONLY-SIZE 1 ONLY Standard Configuration with .0008-.0012 thick nickel plated die cast shell and EMI springs. With floating eyelets (.048 min. radial float) in four corner connector mounting holes.
37 -	PLUG CONNECTORS ONLY With metric clinch nuts M3 X 6 (See Table for quantities)		
38 -	PLUG CONNECTORS ONLY With metric clinch nuts M3 X 6 (See Table for quantities) and with .0008-.0012 thick nickel plated shell. The shell is provided with an EMI/ Grounding spring. Metallic inserts, if supplied, are selectively plated - I.D. Silver; O.D. Nickel over Silver. The contact retaining/ grounding clips are gold plated.		
45 -	PLUG CONNECTORS ONLY Standard Configuration with .0008-.0012 thick nickel plated die cast shell. The shell is provided without an EMI/Grounding spring.		
46 -	PLUG AND RECEPTACLE CONNECTORS .148 dia. connector mounting holes. SURTEC 650V ROHS Compliant plating.		

Mounting Modifier	Shell Size	Quantity of Clinch Nuts	
		Plug Connector	Receptacle Connector
01, 03, 04, 06, 25, 37, 38, 47, 50	1	4	4
	2	4	6
	3	8	10
08, 09, 48	1	4	4
	2	10	10
	3	12	14

Dimensions shown in inches (mm)
Specifications and dimensions subject to change

BJA (ARINC 600)

How to Order (continued)

Modifier (Contact, Finish, Material)

BLANK -	Rear release, crimp, signal and power contacts supplied with connector (when applicable)	SU -	Front release solder PCB contacts installed .375 (9.53) including Coax, Triax, and Quadrax. All contacts to be PCB.
F0 -	Contacts not supplied with connector (F0 not stamped on connector)	SV -	Front release solder PCB contacts installed .500 (12.7) including Coax, Triax, and Quadrax. All contacts to be PCB.
F00 -	Less contacts and waveguide (F00 not stamped on connector)	SW -	Front release solder PCB contacts installed .150 (3.81) including Quadrax. (Coax and Triax does not have contacts installed)
SE -	Front release solder PCB contacts installed .150 (3.81). (Coax, Triax, and Quadrax does not have contacts installed)	SX -	Front release solder PCB contacts installed .250 (6.35) including Quadrax. (Coax and Triax does not have contacts installed)
SF -	Front release solder PCB contacts installed .250 (6.35). (Coax, Triax, and Quadrax does not have contacts installed)	SY -	Front release solder PCB contacts installed .375 (9.53) including Quadrax. (Coax and Triax does not have contacts installed)
SG -	Front release solder PCB contacts installed .375 (9.53). (Coax, Triax, and Quadrax does not have contacts installed)	SZ -	Front release solder PCB contacts installed .500 (12.7) including Quadrax. (Coax and Triax does not have contacts installed)
SH -	Front release solder PCB contacts installed .500 (12.7). (Coax, Triax, and Quadrax does not have contacts installed)	WA -	Front release .025(0.63) Sq. x .250 (6.35) (1 wrap) wrap post and crimp, rear release power contacts (when applicable) supplied with connector
SS -	Front release solder PCB contacts installed .150 (3.81) including Coax, Triax, and Quadrax. All contacts to be PCB.	WB -	Front release .025(0.63) Sq. x .375 (9.53) (2 wraps) wrap post and crimp, rear release power contacts (when applicable) supplied with connector
ST -	Front release solder PCB contacts installed .250 (6.35) including Coax, Triax, and Quadrax. All contacts to be PCB.		

NOTE: Coaxial contacts to be ordered separately.

All Fiber Optic layouts will not have Fiber Optic contacts installed

BA (ARINC 600)

Contact Arrangements

Fiber Optic Contact Arrangements

Introducing the New ARINC 801 Inserts for BA (ARINC 600) Connectors

Designed for use in applications that require quick and accurate data transfer, Cannon's **ARINC 801 Fiber Optic Interconnect Solutions** are capable of operating at transmission speeds of 10 gigabits/sec (Gb/S) or more. Built for optimum performance in extreme conditions, our ARINC 801 Fiber Optic Series delivers signal, video and data when it matters most.

Several standard ARINC 600 insert arrangements are available for Cannon's Rack & Panel connector family.



12F12



17Q2



12F5C2



20F12Q8
20F12T8



F36

Insert	Description	Shell Size	Shell Style	Cavity
12F12	12 #16 Fiber Optic	1	BKAC/BKAD/BKAE/BKAF	C
17Q2	12 #16 Fiber Optic 3 #16 2 #8 (Quadrx)	2/3		C or F
12F5C2	5 #16 Fiber Optic 4 #12 1 #16 2 #5 (Coax)			A,B,D,E
20F12Q8 20F12T8	12 #16 Fiber Optic 8 #8 (Quadrx or Twinax)			
F36	36 #16 Fiber Optic			

Dimensions shown in inches (mm)
Specifications and dimensions subject to change

BA (ARINC 600)

Contact Arrangements (continued)

Shell Size 1 - BKAC/BKAD/BKAE/BKAF/BKAX Cavity A or B Contact Arrangements
(Plug rear face shown)

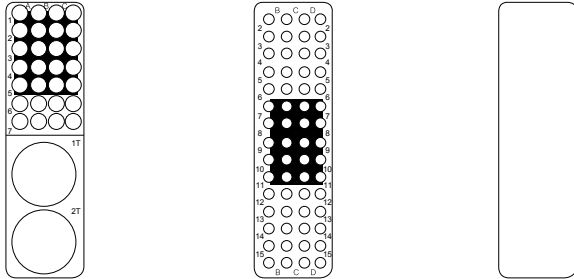

BKAC/BKAD/BKAE
Rear surface white on blue to indicate rear release rear removal contacts

BKAF/BKAX (Front Release)
Engaging end surface white on red to indicate front release front removal contacts

30T2 / 30Q2	60	Blank
28 #22 2 # 8 Twinax/Coax/Quadrax (#8 Grounded to Shell)	60 #22	No Contacts

Shell Size 1 - BKAC/BKAD/BKAE/BKAF/BKAX Shell Cavity C Contact Arrangements
(Plug rear face shown)

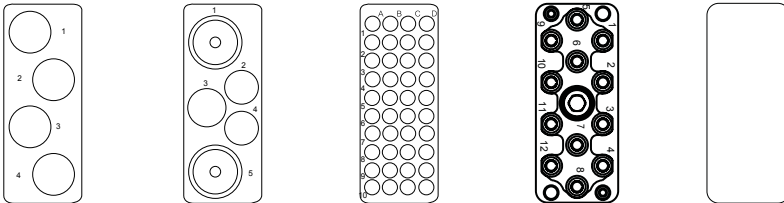

BKAC/BKAD/BKAE
Rear surface white on blue to indicate rear release rear removal contacts

BKAF/BKAX (Front Release)
Engaging end surface white on red to indicate front release front removal contacts

4 / 4T4 A4W4	5W2	40	12F12	Blank
4 #12	1 #12 2 #16 2 #5 Coax	40 #22	12 #16 Fiber Optic	No Contacts

Shell Size 2/3 - BKAC/BKAD/BKAE/BKAF/BKAX Shell Cavity A,B,D,E Contact Arrangements
(Plug rear face shown)

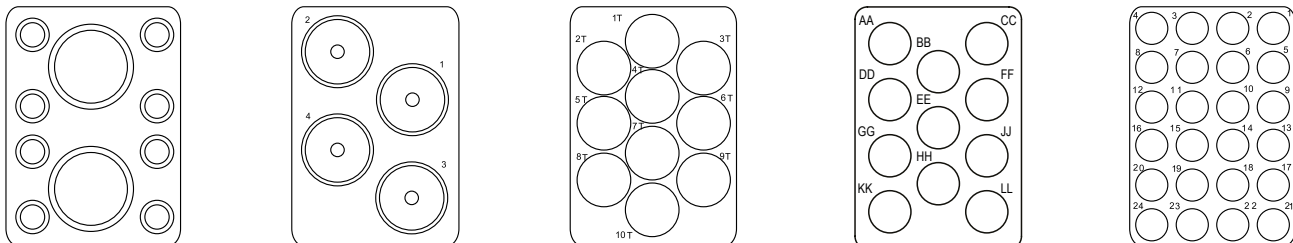

2W2 / 2G2	4W4	10T10 / 10P10	11Q11	24
2 #1 Coax	4 Modified #1 Coax (Metallic Insert)	10 #8 Triax/Coax (#8 Grounded to Shell) (Metallic Insert)	11 #8 Quadrax	24 #12

For Contacts Cavity Location and Contact Cavity Identification refer to ARINC 600 or Consult Your Account Representative.

Dimensions shown in inches (mm)
Specifications and dimensions subject to change

BAK (ARINC 600)

Contact Arrangements (continued)

Shell Size 2/3 - BKAC/BKAD/BKAE/BKAF/BKAX Shell Cavity A,B,D,E Contact Arrangements
(Plug rear face shown)

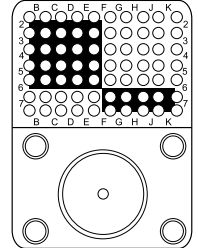
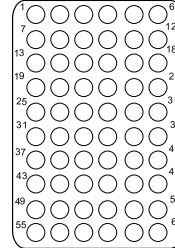
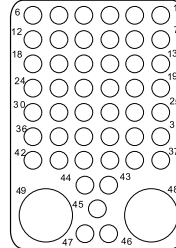
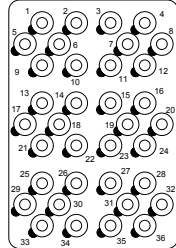
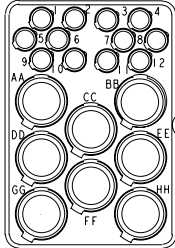

20F12Q8 / 20F12T8	F36	49T2	60	71W1 / 71W1A
12 #16 Fiber Optic 8 #8 Quadradx	36 #16 Fiber Optic	47 #20 2 #8 Triax	60 #20	70 #22 1 #1 Coax

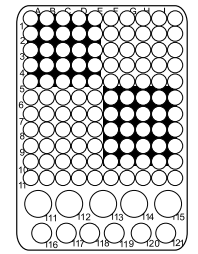
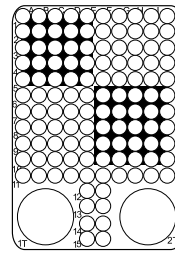
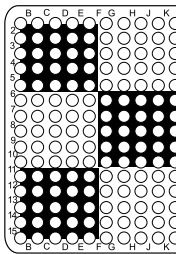
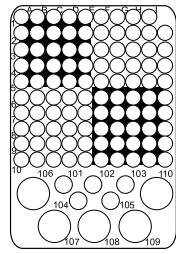
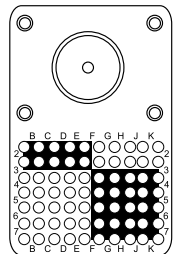

71W1B	110	150	120T2 / 120Q2	121
70 #22 1 #1 Coax	100 #22 5 #12 5 #20	150 #22	118 #22 2 #8 Twinax/Coax/Quadradx (#8 Grounded to Shell)	110 #22 5 #16 6 #20

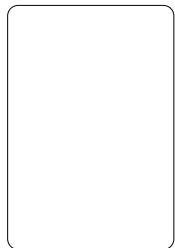

Blank
No Contacts

BKAC/BKAD/BKAE

Rear surface white on blue to indicate rear release rear removal contacts for inserts containing standard signal & power contacts

BKAF/BKAX (Front Release)

Engaging end surface white on red to indicate front release front removal contacts for inserts containing standard signal & power contacts

Shell Size 2/3 - BKAC/BKAD/BKAE/BKAF/BKAX Shell Cavity C or F Contact Arrangements
(Plug rear face shown)

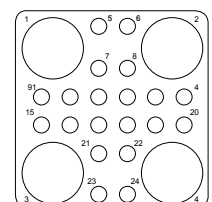
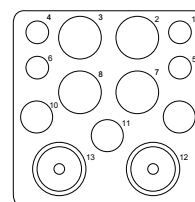
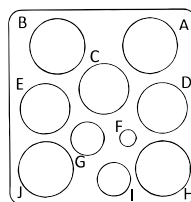
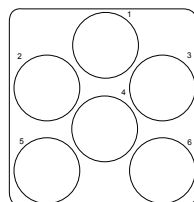
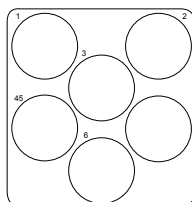

6	6T6 / 6Q6 / 6QA6 / 6P6	10C5T2	13W2 / 13Q2 / 13WQ2	24T4 / 24Q4
6 #8	6 #8 Triax/Quadradx (Metallic Insert)	1 #20 2 #20 Insulated 2 #8 Triax 5 #5 Coax	4 #20 4 #12 3 #16 2 #5 Coax/ #8 Quadradx	20 #20 4 #8 Triax/Quadradx

For Contacts Cavity Location and Contact Cavity Identification refer to ARINC 600 or Consult Your Account Representative.

Dimensions shown in inches (mm)

Specifications and dimensions subject to change

BJA (ARINC 600)

Contact Arrangements (continued)

Shell Size 2/3 - BKAC/BKAD/BKAE/BKAF/BKAX Shell Cavity C or F Contact Arrangements
(Plug rear face shown)

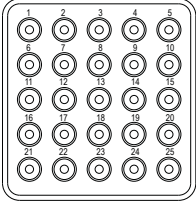
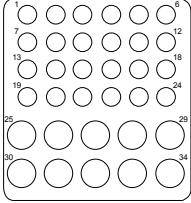
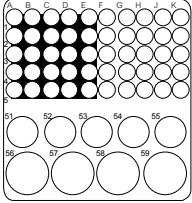
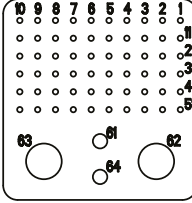
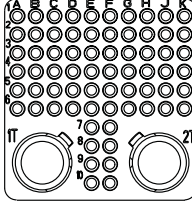
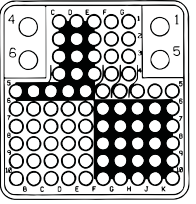
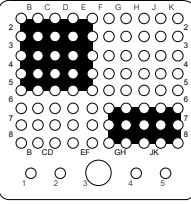
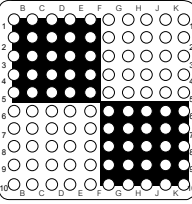
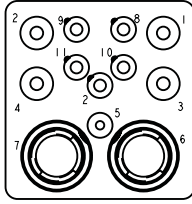
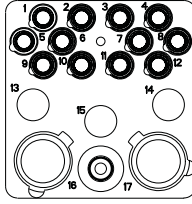
				
25	34	59	64Q2	70Q2
25 #16	24 #20HD 10 #16	50 #22 5 #16 4 #12	60 #22 2 #16 2 #8 Quadrax	68 #22 2 #8 Quadrax
				
84	85	100	12F5C2	17Q2
80 #22 4 #20	80 #22 4 #20 1 #16	100 #22	1 #16 4 #12 2 #5 Coax 5 #16 Fiber Optic	3 #16 2 #8 Quadrax 12 #16 Fiber Optic

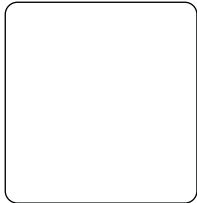

Blank

No Contacts

BKAC/BKAD/BKAE

Rear surface white on blue to indicate rear release rear removal contacts for inserts containing standard signal & power contacts

NOTE: In layouts using #22 contacts mixed with any other contact size (20HD, 16, 12), the size #22 contact type (pin or socket) determines the insulator as a pin insert or a socket insert.

BKAF/BKAX (Front Release)

Engaging end surface white on red to indicate front release, front removal contacts for inserts containing standard signal & power contacts

NOTE #22 Contacts are Socket contacts, 20HD, 16, 12 are Pin contacts.

For Contacts Cavity Location and Contact Cavity Identification refer to ARINC 600 or Consult your account representative.

Shell Size 2/3 BKAC/BKAD/BKAE Shell Cavity A,B,D,E Contact Arrangements - PHD Fiber Optic ARINC 600

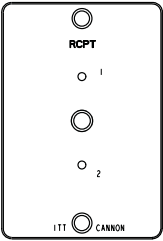
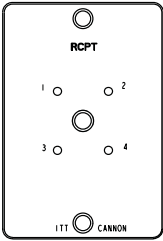
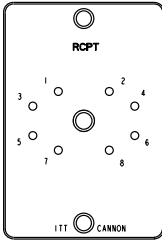
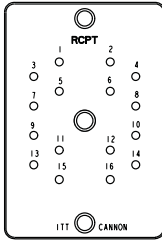
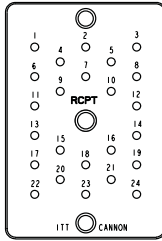
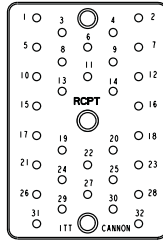
					
PHD-2	PHD-4	PHD-8	PHD-16	PHD-24	PHD-32

All arrangements utilize PHD-T16-**** size 16 fiber optic termini. Please consult your account representative for higher density (72 and 88 cavity) layouts utilizing PHD-T22-**** size 22 fiber optic termini

All layouts shown are Receptacle engaging face and rear release.

Dimensions shown in inches (mm)
Specifications and dimensions subject to change

BJA (ARINC 600)

Shell Cavity Identification

CONNECTOR LAYOUT DESCRIPTION Note: All layouts with "OPEN" insert cavity are not supplied with an insulator. If a blank insert is required, please consult your account representative; all standard blank inserts are plastic. Three digit number contained within the shell layout indicates total number of contacts available (including Waveguide).

Insert Designator Number - Shell Size 1

ITT Cannon	Cavity A	Cavity B	Cavity C	ITT Cannon	Cavity A	Cavity B	Cavity C
5	OPEN	OPEN	5W2	A094	30T2	60	4
35	30T2	BLANK	5W2	95	60	30T2	5W2
60	OPEN	60	OPEN	A095	30T2	60	5W2
A060	60	OPEN	OPEN	A100	60	BLANK	40
64	30T2	30T2	4	120	60	60	OPEN
65	OPEN	60	5W2	124	60	60	4
A065	60	OPEN	5W2	125	60	60	5W2
B065	30T2	30T2	5W2	130	60	30T2	40
C065	BLANK	60	5W2	A130	30T2	60	40
94	60	30T2	4	160	60	60	40

Insert Designator Number - Shell Size 2

ITT Cannon	Cavity A	Cavity B	Cavity C	ITT Cannon	Cavity A	Cavity B	Cavity C
13	OPEN	OPEN	13W2	B121	121	OPEN	OPEN
017M	2W2	2W2	13W2	122	49T2	49T2	24T2
019M	4W4	2W2	13W2	124	BLANK	24	100
Q34	11Q11	10T10	13Q2	133	60	60	13W2
Q035	11Q11	11Q11	13Q2	A133	24	24	85
59	BLANK	BLANK	59	Q135	11Q11	24	100
66	BLANK	60	6	137	121	10T10	6T6
Q69	11Q11	24	34	142	71W1	71W1	OPEN
71	OPEN	71W1	OPEN	143	120T2	10T10	13W2
A071	71W1	OPEN	OPEN	Q144	120T2	11Q11	13W2
Q074	4W4	11Q11	59	Q154	120T2	11Q11	13W2
Q075	11Q11	BLANK	64Q2	155	71W1	71W1	13W2
Q81	11Q11	11Q11	59	155M	71W1A	71W1A	13W2
084M	BLANK	71W1A	13W2	V155M	71W1B	71W1A	13W2
085M	WAVEGUIDE	71W1	13W2	158M	2W2	71W1A	85
A085M	71W1	WAVEGUIDE	13W2	A158M	2W2	71W1B	85
B085	OPEN	OPEN	85	163	OPEN	150	13W2
086M	2W2	71W1A	13W2	A163	150	OPEN	13W2
Q086	11Q11	11Q11	64Q2	QB163	OPEN	150	13Q2
Q089	4W4	BLANK	85	164	150	WAVEGUIDE	13W2
93	4W4	4W4	85	A164	WAVEGUIDE	150	13W2
Q096	BLANK	11Q11	85	A165M	2W2	150	13W2
100	OPEN	OPEN	100	167	4W4	150	13W2
A100	BLANK	OPEN	100	173M	2W2	71W1B	100
Q107	11Q11	11Q11	85	A173	150	10T10	13W2
109	60	49T2	BLANK	B173	10T10	150	13W2
120	60	60	METAL BLANK	187	24	150	13W2
121	OPEN	121	OPEN	Q225	11Q11	150	64Q2
A121	121	BLANK	BLANK	A234M	71W1A	150	13W2

OTHER COMBINATION OF INSERTS WITHIN A SPECIFIC SHELL ARE AVAILABLE UPON REQUEST, PLEASE CONSULT YOUR ACCOUNT REPRESENTATIVE.

Dimensions shown in inches (mm)
Specifications and dimensions subject to change

BA (ARINC 600)

Shell Cavity Identification (continued)

CONNECTOR LAYOUT DESCRIPTION Note: All layouts with "OPEN" insert cavity are not supplied with an insulator. If a blank insert is required, please consult your account representative; all standard blank inserts are plastic. Three digit number contained within the shell layout indicates total number of contacts available (including Waveguide).

Insert Designator Number - Shell Size 2 (continued)

ITT Cannon	Cavity A	Cavity B	Cavity C	ITT Cannon	Cavity A	Cavity B	Cavity C
235	150	BLANK	85	301	121	121	59
240	60	121	59	306	150	150	6T6
246	120T2	120T2	6T6	313	150	150	13W2
Q246	150	11Q11	85	Q313	150	150	13WQ2
248	121	121	6T6	324	150	150	24T4
250	OPEN	150	100	Q324	150	150	24Q4
A250	150	BLANK	100	327	121	121	8
251	WAVEGUIDE	150	100	330	150	121	59
Q253	120T2	120T2	13WQ2	340	120T2	120T2	100
254	110	110	34	342	121	121	100
A284	121	150	13W2	370	120T2	150	100
300	150	150	OPEN	400	150	150	100

Insert Designator Number - Shell Size 3

ITT Cannon	Cavity A	Cavity B	Cavity C	Cavity D	Cavity E	Cavity F
21	4W4	4W4	13W2	BLANK	OPEN	OPEN
26	OPEN	OPEN	13W2	OPEN	OPEN	13W2
113	OPEN	OPEN	100	OPEN	OPEN	13W2
A113	OPEN	OPEN	13W2	OPEN	OPEN	100
114	4W4	4W4	13W2	4W4	4W4	85
Q198	11Q11	11Q11	13Q2	11Q11	11Q11	13Q2
Q209	11Q11	11Q11	BLANK	11Q11	150	13Q2
Q253	150	121	13W2	11Q11	24	34
Q261	4W4	120T2	BLANK	4W4	120T2	13Q2
269M	2W2	2W2	13W2	2W2	150	100
271C	4W4	4W4	13W2	BLANK	150	100
271M	2W2	2W2	13W2	4W4	150	100
Q274	4W4	120T2	13Q2	4W4	120T2	13Q2
284	71W1	71W1	OPEN	71W1	71W1	OPEN
Q307	110	11Q11	6Q6	24	150	6Q6
310	71W1	71W1	13W2	71W1	71W1	13W2
Q324	11Q11	METAL BLANK	METAL BLANK	150	150	13Q2
326	OPEN	150	13W2	OPEN	150	13W2
330M	2W2	2W2	13W2	150	150	13W2
A330M	150	150	13W2	2W2	2W2	13W2
Q435	11Q11	11Q11	13Q2	150	150	100
Q487	11Q11	150	13Q2	150	150	13Q2
496	121	121	6T6	121	121	6T6
600	150	150	OPEN	150	150	OPEN
Q619	150	150	13Q2	150	150	6T6
626	150	150	13W2	150	150	13W2
Q626	150	150	13Q2	150	150	13Q2
713	150	150	100	150	150	13W2
734	150	150	100	150	150	34
800	150	150	100	150	150	100

OTHER COMBINATION OF INSERTS WITHIN A SPECIFIC SHELL ARE AVAILABLE UPON REQUEST, PLEASE CONSULT YOUR ACCOUNT REPRESENTATIVE.

Dimensions shown in inches (mm)
Specifications and dimensions subject to change

BAK (ARINC 600)

Shell Dimensions

Plug Dimensions - Shell Size 1

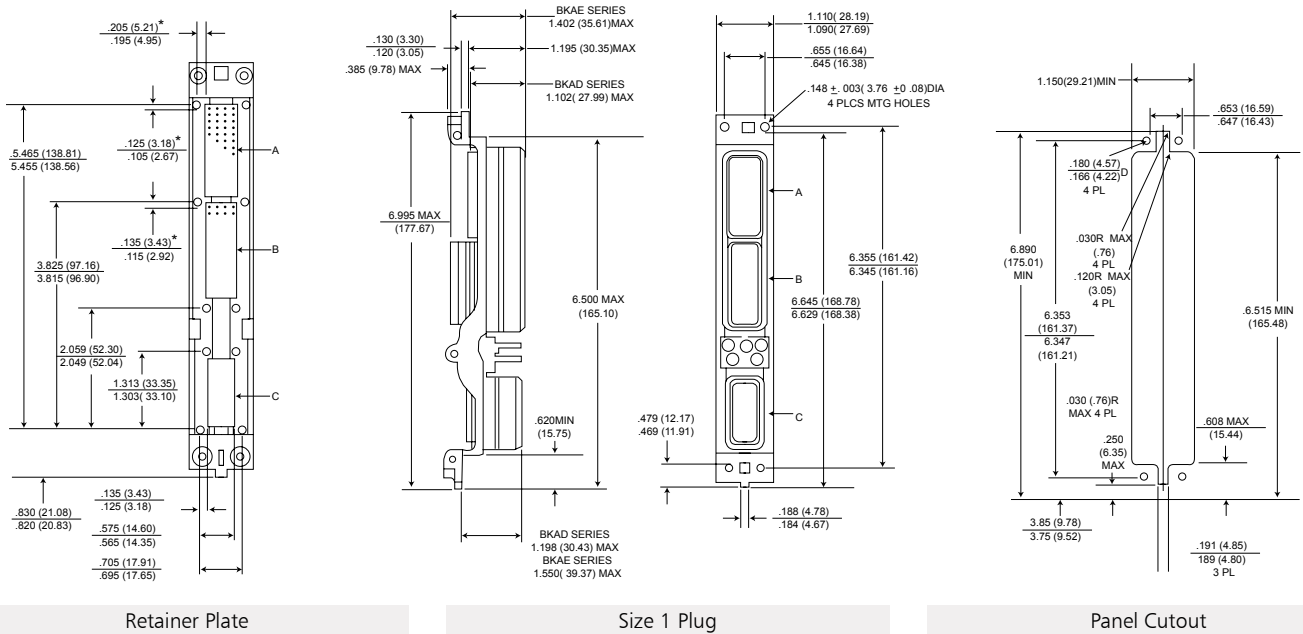

Receptacle Dimensions - Shell Size 1

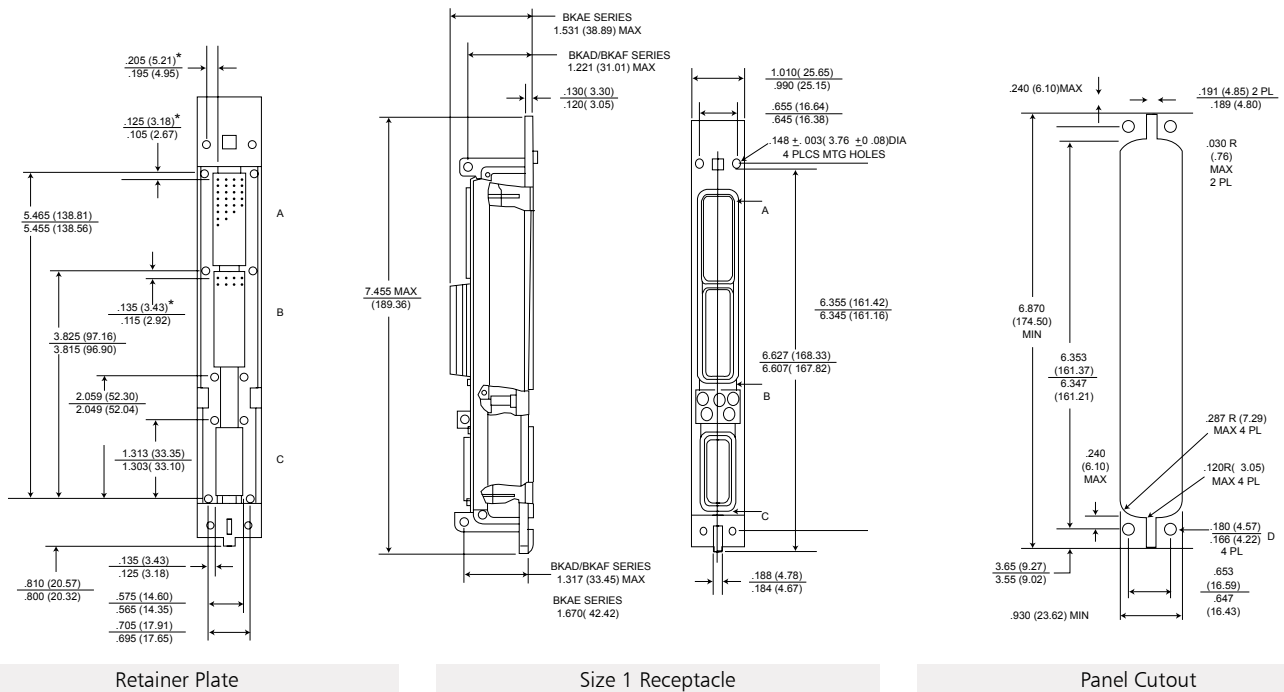

For further information, refer to ARINC 600 specification or consult your account representative.
 *This dimension indicates distance from centerline of retaining screw to the centerline of first contact cavity.

Dimensions shown in inches (mm)
 Specifications and dimensions subject to change

BKA (ARINC 600)

Shell Dimensions - (continued)

Plug Dimensions - Shell Size 2

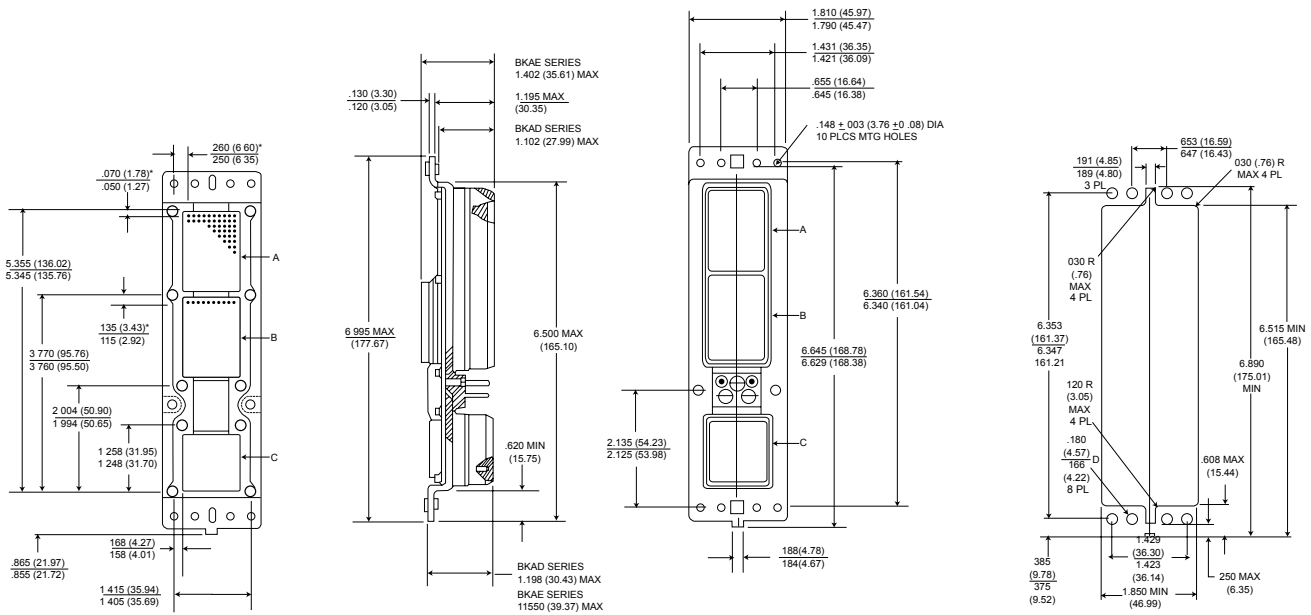

Retainer Plate

Size 2 Plug

Panel Cutout

Receptacle Dimensions - Shell Size 2

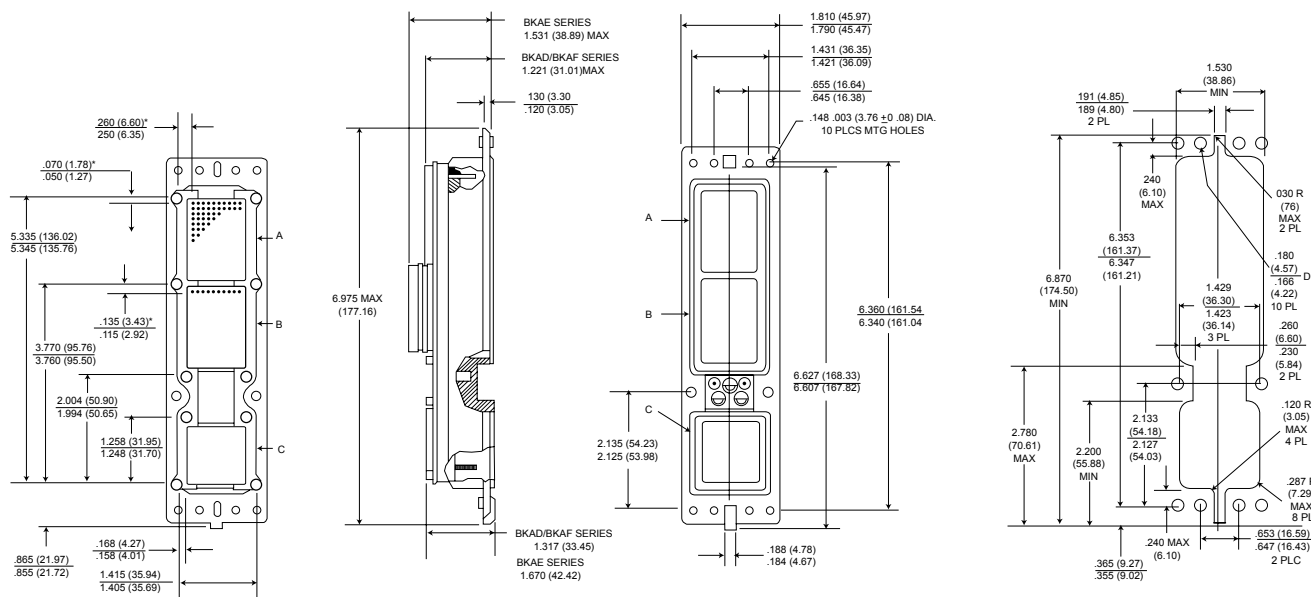

Retainer Plate

Size 2 Receptacle

Panel Cutout

*This dimension indicates distance from centerline of retaining screw to the centerline of first contact cavity. For further information, refer to ARINC 600 specification or consult factory.

Dimensions shown in inches (mm)
Specifications and dimensions subject to change

BA (ARINC 600)

Shell Dimensions - (continued)

Plug Dimensions - Shell Size 3

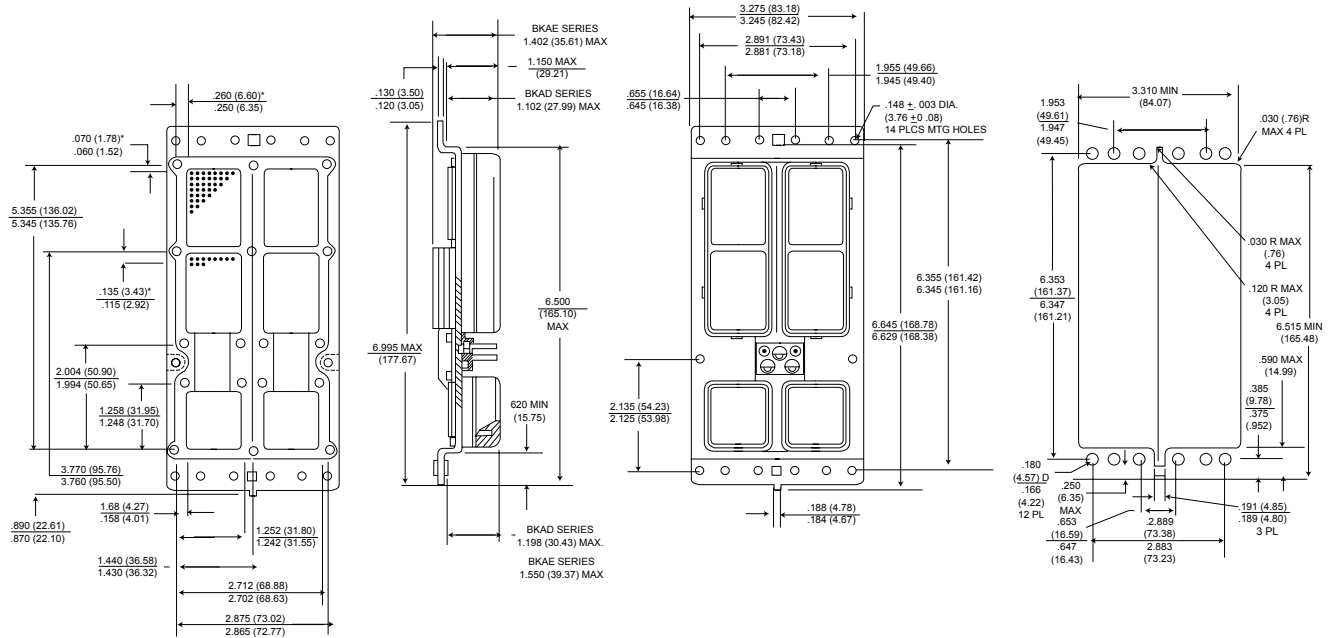

Retainer Plate

Size 3 Plug

Panel Cutout

Receptacle Dimensions - Shell Size 3

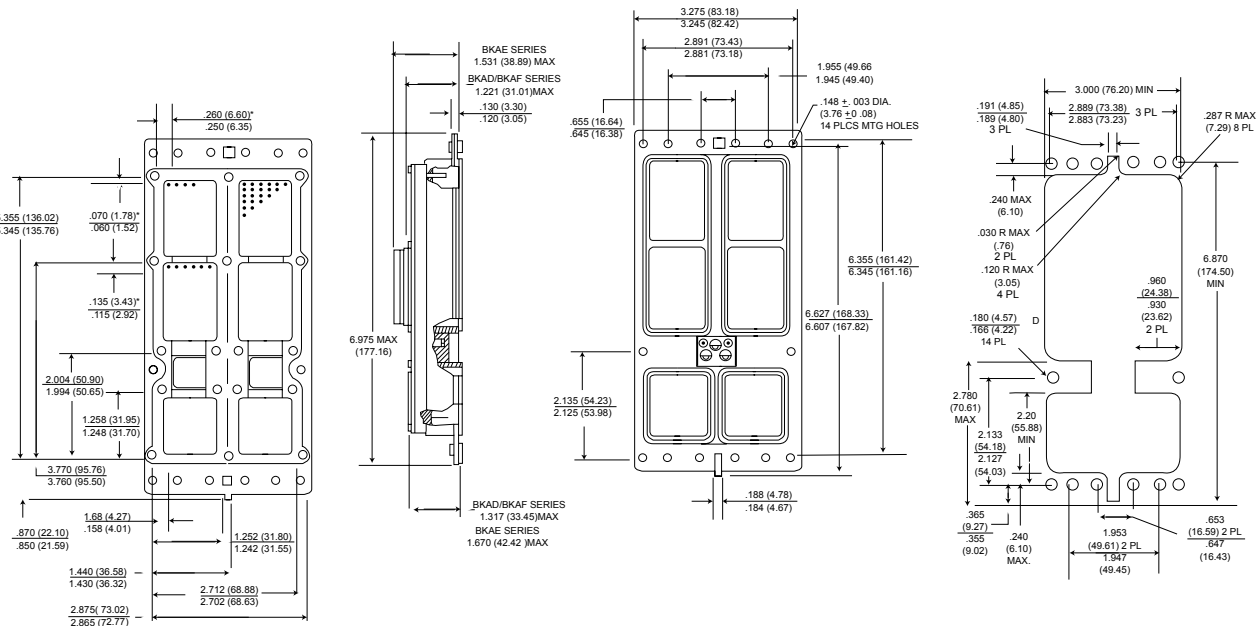

Retainer Plate

Size 3 Receptacle

Panel Cutout

*This dimension indicates distance from centerline of retaining screw to the centerline of first contact cavity. For further information, refer to ARINC 600 specification or consult factory.

Dimensions shown in inches (mm)

Specifications and dimensions subject to change

BA (ARINC 600)

Shell Dimensions (continued)

ARINC 600 Connector Engaging Sequence

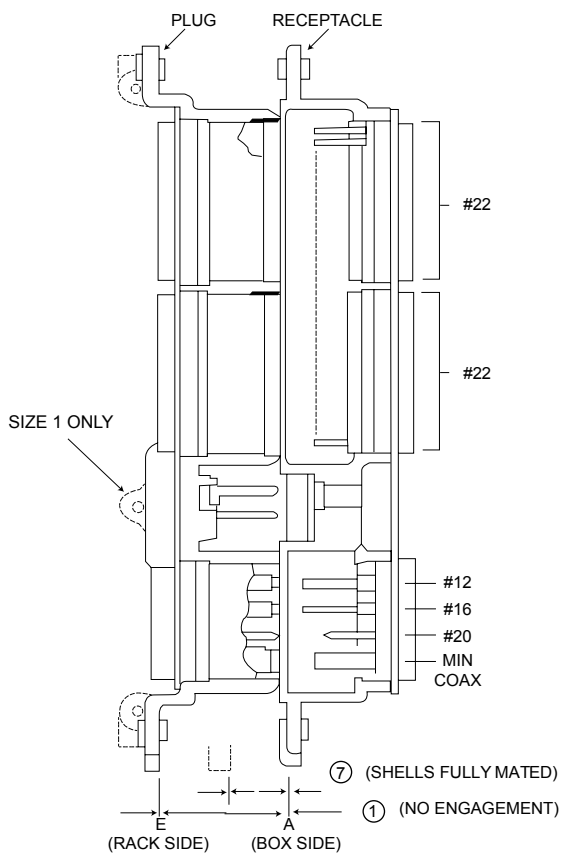

Mating Sequence	Flange Position With:	Flange Spacing in. (mm)
①	No Engagement	1.245 (31.62) Nom.
2	Shells Initially Engaged	1.110 (28.19) 1.073 (27.25)
3	Polarizing Pins Entering Keys	1.073 (27.25) 1.023 (25.88)
4	Contacts Entering Mating Insulator	#22 .800 (22.32) .748 (18.99)
		#20 .805 (20.44) .741 (18.82)
		#16 1.012 (25.70) .949 (24.10)
		#12 1.008 (23.60) .953 (24.20)
		Miniature Coax Varies; See Mil-Spec. (#5 Coax)
5	Contacts Electrically Engaged	#22 .642 (16.30) .547 (13.89)
		#20 .649 (16.48) .553 (14.04)
		#16 .728 (18.49) .818 (20.77)
		#12 .772 (19.60) .692 (17.57)
		Miniature Coax Varies; See Mil-Spec. (#5 Coax)
6	"0" Ring Engagement (BKAE Only)	.618 (15.70) .578 (14.68)
⑦	Shells Fully Mated	.522 (13.26) .488 (12.40)

Notes:

Flush head screws are not permitted for connector mounting as they would position connector incorrectly

Dimension 7 was calculated to provide clearance for:

MCU backplate material thickness of 2.5 mm (.10 in)

Rack backplate material thickness of 2.5 mm (.10 in)

Connector mounting pan head screws, MCU 2.0 mm (.08 in)

Tolerance allowance: 3.2 mm (.13 in.) rack 2.0 mm (.08 in.)

Total: 12.2 (.50 in) (minimum)

Dimensions shown in inches (mm)
Specifications and dimensions subject to change

BA (ARINC 600)

Shell Dimensions (continued)

Waveguide Connections

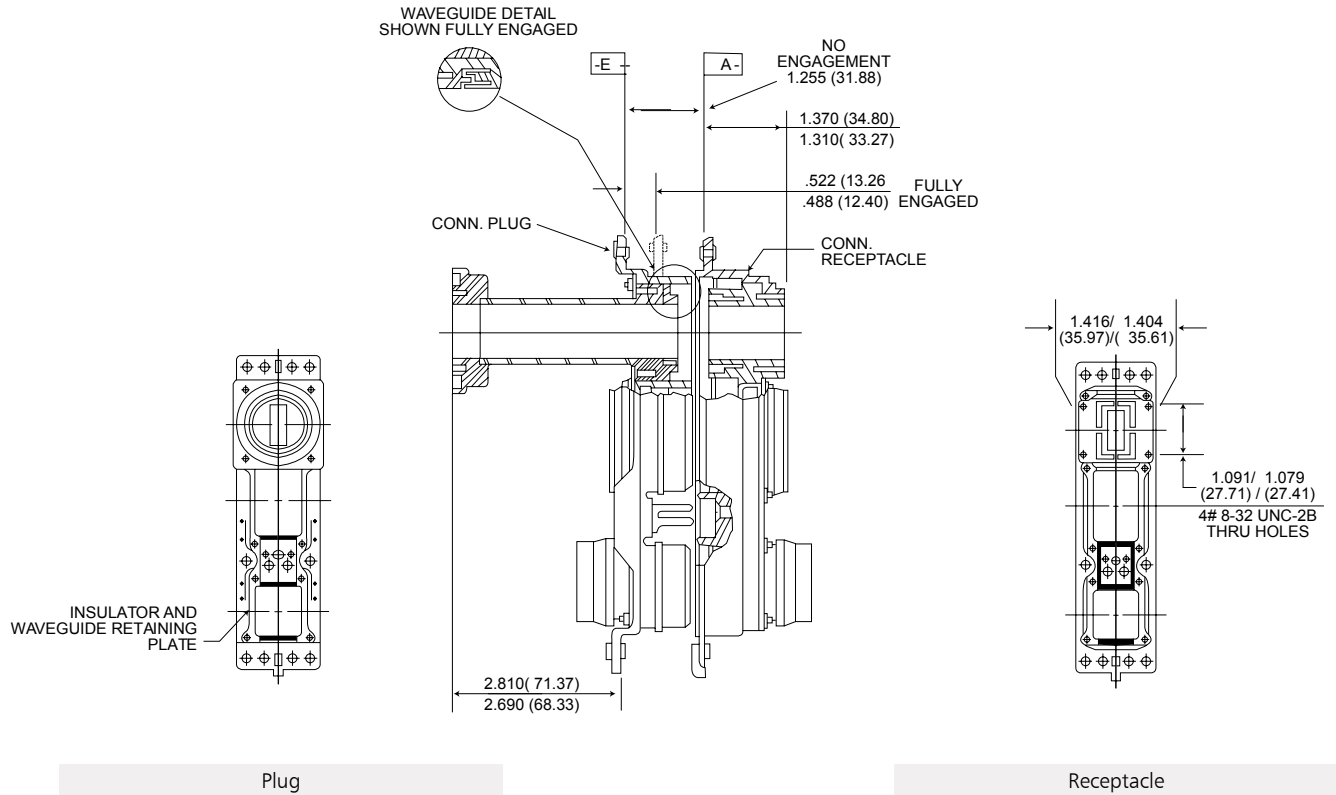

Polarization (Engaging End)

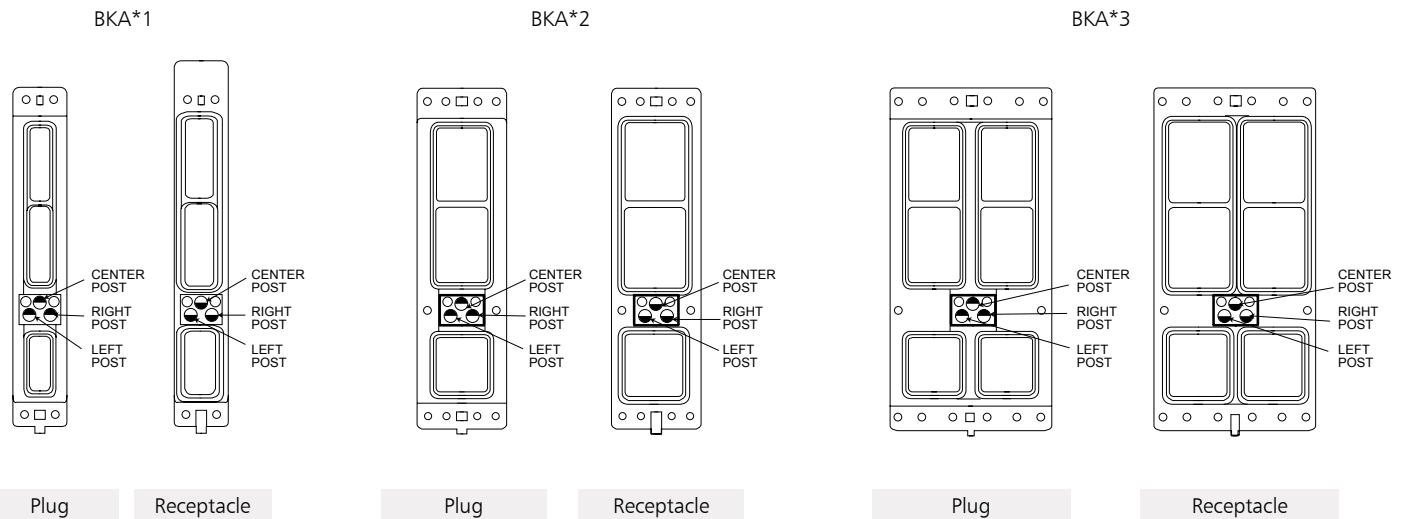

Dimensions shown in inches (mm)
Specifications and dimensions subject to change

BJA (ARINC 600)

Polarization

Polarizing Positions



Dark area represents post on a plug, light area represents key opening on a receptacle

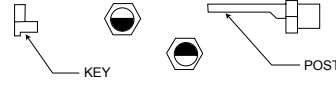

Polarization Kits available
- See Page 77

CONNECTOR PLUG												CONNECTOR RECEPTACLE											
Position	Last Post	Center Post	Right Post	Position	Last Post	Center Post	Right Post	Position	Last Post	Center Post	Right Post	Position	Last Post	Center Post	Right Post	Position	Last Post	Center Post	Right Post				
01	1	1	1	73	1	3	1	145	1	5	1	01	4	4	4	73	4	2	4	145	4	6	4
02	2	1	1	74	2	3	1	146	2	5	1	02	4	4	3	74	4	2	3	146	4	6	3
03	3	1	1	75	3	3	1	147	3	5	1	03	4	4	2	75	4	2	2	147	4	6	2
04	4	1	1	76	4	3	1	148	4	5	1	04	4	4	1	76	4	2	1	148	4	6	1
05	5	1	1	77	5	3	1	149	5	5	1	05	4	4	6	77	4	2	6	149	4	6	6
06	6	1	1	78	6	3	1	150	6	5	1	06	4	4	5	78	4	2	5	150	4	6	5
07	1	1	6	79	1	3	6	151	1	5	6	07	5	4	4	79	5	2	4	151	5	6	4
08	2	1	6	80	2	3	6	152	2	5	6	08	5	4	3	80	5	2	3	152	5	6	3
09	3	1	6	81	3	3	6	153	3	5	6	09	5	4	2	81	5	2	2	153	5	6	2
10	4	1	6	82	4	3	6	154	4	5	6	10	5	4	1	82	5	2	1	154	5	6	1
11	5	1	6	83	5	3	6	155	5	5	6	11	5	4	6	83	5	2	6	155	5	6	6
12	6	1	6	84	6	3	6	156	6	5	6	12	5	4	5	84	5	2	5	156	5	6	5
13	1	1	5	85	1	3	5	157	1	5	5	13	6	4	4	85	6	2	4	157	6	6	4
14	2	1	5	86	2	3	5	158	2	5	5	14	6	4	3	86	6	2	3	158	6	6	3
15	3	1	5	87	3	3	5	159	3	5	5	15	6	4	2	87	6	2	2	159	6	6	2
16	4	1	5	88	4	3	5	160	4	5	5	16	6	4	1	88	6	2	1	160	6	6	1
17	5	1	5	89	5	3	5	161	5	5	5	17	6	4	6	89	6	2	6	161	6	6	6
18	6	1	5	90	6	3	5	162	6	5	5	18	6	4	5	90	6	2	5	162	6	6	5
19	1	1	4	91	1	3	4	163	1	5	4	19	1	4	4	91	1	2	4	163	1	6	4
20	2	1	4	92	2	3	4	164	2	5	4	20	1	4	3	92	1	2	3	164	1	6	3
21	3	1	4	93	3	3	4	165	3	5	4	21	1	4	2	93	1	2	2	165	1	6	2
22	4	1	4	94	4	3	4	166	4	5	4	22	1	4	1	94	1	2	1	166	1	6	1
23	5	1	4	95	5	3	4	167	5	5	4	23	1	4	6	95	1	2	6	167	1	6	6
24	6	1	4	96	6	3	4	168	6	5	4	24	1	4	5	96	1	2	5	168	1	6	5
25	1	1	3	97	1	3	3	169	1	5	3	25	2	4	4	97	2	2	4	169	2	6	4
26	2	1	3	98	2	3	3	170	2	5	3	26	2	4	3	98	2	2	3	170	2	6	3
27	3	1	3	99	3	3	3	171	3	5	3	27	2	4	2	99	2	2	2	171	2	6	2
28	4	1	3	100	4	3	3	172	4	5	3	28	2	4	1	100	2	2	1	172	2	6	1
29	5	1	3	101	5	3	3	173	5	5	3	29	2	4	6	101	2	2	6	173	2	6	6
30	6	1	3	102	6	3	3	174	6	5	3	30	2	4	5	102	2	2	5	174	2	6	5
31	1	1	2	103	1	3	2	175	1	5	2	31	3	4	4	103	3	2	4	175	3	6	4
32	2	1	2	104	2	3	2	176	2	5	2	32	3	4	3	104	3	2	3	176	3	6	3
33	3	1	2	105	3	3	2	177	3	5	2	33	3	4	2	105	3	2	2	177	3	6	2
34	4	1	2	106	4	3	2	178	4	5	2	34	3	4	1	106	3	2	1	178	3	6	1
35	5	1	2	107	5	3	2	179	5	5	2	35	3	4	6	107	3	2	6	179	3	6	6
36	6	1	2	108	6	3	2	180	6	5	2	36	3	4	5	108	3	2	5	180	3	6	5
37	1	2	1	109	1	4	1	181	1	6	1	37	4	3	4	109	4	1	4	181	4	5	4
38	2	2	1	110	2	4	1	182	2	6	1	38	4	3	3	110	4	1	3	182	4	5	3
39	3	2	1	111	3	4	1	183	3	6	1	39	4	3	2	111	4	1	2	183	4	5	2
40	4	2	1	112	4	4	1	184	4	6	1	40	4	3	1	112	4	1	1	184	4	5	1
41	5	2	1	113	5	4	1	185	5	6	1	41	4	3	6	113	4	1	6	185	4	5	6
42	6	2	1	114	6	4	1	186	6	6	1	42	4	3	5	114	4	1	5	186	4	5	5
43	1	2	6	115	1	4	6	187	1	6	6	43	5	3	4	115	5	1	4	187	5	5	4
44	2	2	6	116	2	4	6	188	2	6	6	44	5	3	3	116	5	1	3	188	5	5	3
45	3	2	6	117	3	4	6	189	3	6	6	45	5	3	2	117	5	1	2	189	5	5	2
46	4	2	6	118	4	4	6	190	4	6	6	46	5	3	1	118	5	1	1	190	5	5	1
47	5	2	6	119	5	4	6	191	5	6	6	47	5	3	6	119	5	1	6	191	5	5	6
48	6	2	6	120	6	4	6	192	6	6	6	48	5	3	5	120	5	1	5	192	5	5	5
49	1	2	5	121	1	4	5	193	1	6	5	49	6	3	4	121	6	1	4	193	6	5	4
50	2	2	5	122	2	4	5	194	2	6	5	50	6	3	3	122	6	1	3	194	6	5	3
51	3	2	5	123	3	4	5	195	3	6	5	51	6	3	2	123	6	1	2	195	6	5	2
52	4	2	5	124	4	4	5	196	4	6	5	52	6	3	1	124	6	1	1	196	6	5	1
53	5	2	5	125	5	4	5	197	5	6	5	53	6	3	6	125	6	1	6	197	6	5	6
54	6	2	5	126	6	4	5	198	6	6	5	54	6	3	5	126	6	1	5	198	6	5	5
55	1	2	4	127	1	4	4	199	1	6	4	55	1	3	4	127	1	1	4	199	1	5	4
56	2	2	4	128	2	4	4	200	2	6	4	56	1	3	3	128	1	1	3	200	1	5	3
57	3	2	4	129	3	4	4	201	3	6	4	57	1	3	2	129	1	1	2	201	1	5	2
58	4	2	4	130	4	4	4	202	4	6	4	58	1	3	1	130	1	1	1	202	1	5	1
59	5	2	4	131	5	4	4	203	5	6	4	59	1	3	6	131	1	1	6	203	1	5	6
60	6	2	4	132	6	4	4	204	6	6	4	60	1	3	5	132	1	1	5	204	1	5	5
61	1	2	3	133	1	4	3	205	1	6	3	61	2	3	4	133	2	1	4	205	2	5	4
62	2	2	3	134	2	4	3	206	2	6	3	62	2	3	3	134	2	1	3	206	2	5	3
63	3	2	3	135	3	4	3	207	3	6	3	63	2	3	2	135	2	1	2	207	2	5	2
64	4	2	3	136	4	4	3	208	4	6	3	64	2	3	1	136	2	1	1	208	2	5	1
65	5	2	3	137	5	4	3	209	5	6	3	65	2	3	6	137	2	1	6	209	2	5	6
66	6	2	3	138	6	4	3	210	6	6	3	66	2	3	5	138	2	1	5	210	2	5	5
67	1	2	2	139	1	4	2	211	1	6	2	67	3	3	4	139	3	1	4	211	3	5	4
68	2	2	2	140	2	4	2	212	2	6	2	68	3	3	3	140	3	1	3	212	3	5	3
69	3	2	2	141	3	4	2	213	3	6	2	69	3	3	2	141	3	1	2	213	3	5	2
70	4	2	2	142	4	4	2	214	4	6	2	70	3	3	1	142	3	1	1	214	3	5	1
71	5	2	2	143	5	4	2	215	5	6	2	71	3	3	6	143	3	1	6	215	3	5	6
72	6	2	2	144	6	4	2	216	6	6	2	72	3	3	5	144	3	1	5	216	3	5	5

Dimensions shown in inches (mm)
Specifications and dimensions subject to change

SGA (Single Gang ARINC 600)

Product Overview

- Available Rear Release/Rear Removable Front Release/ Front Removable
- Low Insertion force contacts
- Both environmental and non-environmental versions
- Polarizing post that are removable from the mating face
- Field replaceable inserts
- Up to 150 Size #22 contacts per connector
- Crimp, coax, twinax, printed circuit and wire wrapable post style contacts
- Uses standard DPX crimp, insertion/extraction tooling



SGA connectors utilize all the Signal cavity inserts and contacts from the ARINC 600 connector series. They are designed to be used where there are space constraints, in which a standard ARINC 600 connector cannot be used. ITT's SGA connector fills the need for a 150 maximum contact connector with a smaller shell design than Shell Size 2 of ARINC 600, and it has more contacts available than single gang DPX with 106 Size 22 cont acts.

Material Specifications

		SGAD	SGAE	SGAF	Specifications
Shell	Material	Aluminum alloy			QQ-A-591/A380
	Finish	Clear chromate over cadmium			QQ-P-416
Insulator	Material	Thermoplastic		Thermoset	N/A
Contacts	Material	Copper alloy			QQ-C-533
	Finish	Gold over Nickel			MIL-G-45204
	Termination	Crimp		P.C./Wrap Post	N/A
Grommets & Seals	Material	N/A	Silicone-based Elastomer	N/A	
O-Ring					

Dimensions shown in inches (mm)
Specifications and dimensions subject to change

SGA (Single Gang ARINC 600)

How to Order

Product	SGA (Per ARINC 600)	SGA	4	R	F	150	S	00	01	*	-	F0
Shell Style:	<p>3 - Plug (Rack side)</p> <p>4 - Receptacle (Box side)</p>											
RoHS Version:	R - RoHS Compliant Finish: Trivalent Chromate											
Class:	<p>C - Non-environmental with Grommet only, insulators are not potted into the connector shell</p> <p>D - Non-environmental (rear release crimp contacts)</p> <p>E - Environmentally sealed (rear release crimp contacts)</p> <p>F - Non-environmental (front release, printed circuit or wire wrap posts)</p>											
Contact Arrangements:	See Pages 12-14 (BKA ARINC 600 contact arrangements)											
Contact Type:	<p>P - Pin Contacts</p> <p>S - Socket Contacts</p>											
Connector Mounting Modifier:	See Page 25 for Connector Mounting Modifiers											
Polarizing Position:	<p>01 - See Polarization Position chart on Page 28 for Positions 01 through 36</p> <p>00 - 00 for polarization indicates that polarizing hardware is not supplied. Blank or no position indicated means - Polarizing posts or keys not installed but supplied with connector. This allows the user to position the post and stamp the appropriate number on the shell.</p>											
Plating Finish Modifier:	A - PTFE-Ni RoHS Compliant Shell Finish											
Modifier (Contact, Finish, Material):	See Page 10 for Modifiers (Contact, Finish, Material).											

A Refer to page 61 for replacement contact part numbers and required termination tooling information

ANY OTHER COMBINATION OF INSERTS WITHIN A SPECIFIC SHELL IS AVAILABLE UPON REQUEST: For additional layouts, consult your account representative.

Dimensions shown in inches (mm)
Specifications and dimensions subject to change

SGA (Single Gang ARINC 600)

How to Order (continued)

Connector Mounting Modifier

Mounting modifiers 00, 03, 06, 14, 15, hole location is .705 basic from connector vertical centerline

00 - .151 Dia. Mounting holes.

03 - .156 with #4-40 Self-Locking Clinch Nuts (ESNA #22NCFMA2-40) 4 per connector.

06 - .188 Dia. For #6-32 Clinch nuts (ESNA #12NCFMA2-62) 4 per connector.

14 - .137 Dia. Countersunk 82° x .230 Dia., Engaging face of mounting flange.

15 - .137 Dia. Countersunk 82° x .230 Dia., Engaging face of mounting flange. Supplied with slant shield grounding spring.

Mounting modifiers 05, 07, 08, 09, 10, 11, 12, 13, hole location is .650 basic from connector vertical centerline

05 - .208 Dia. for Floating Eyelet.

07 - .212/.204 Slot 4 places.

08 - .120 Dia. Countersunk 82° x .230 Dia., Engaging face of mounting flange.

09 - .120 Dia. Countersunk 82° x .230 Dia., Rear face of mounting flange.

10 - .120 Dia. Countersunk 100° x .230 Dia., Engaging face of mounting flange.

11 - .120 Dia. Countersunk 100° x .230 Dia., Rear face of mounting flange.

13 - .137 Dia. Countersunk 82° x .230 Dia., Rear face of mounting flange.