



Chipsmall Limited consists of a professional team with an average of over 10 year of expertise in the distribution of electronic components. Based in Hongkong, we have already established firm and mutual-benefit business relationships with customers from,Europe,America and south Asia,supplying obsolete and hard-to-find components to meet their specific needs.

With the principle of “Quality Parts,Customers Priority,Honest Operation,and Considerate Service”,our business mainly focus on the distribution of electronic components. Line cards we deal with include Microchip,ALPS,ROHM,Xilinx,Pulse,ON,Everlight and Freescale. Main products comprise IC,Modules,Potentiometer,IC Socket,Relay,Connector.Our parts cover such applications as commercial,industrial, and automotives areas.

We are looking forward to setting up business relationship with you and hope to provide you with the best service and solution. Let us make a better world for our industry!



Contact us

Tel: +86-755-8981 8866 Fax: +86-755-8427 6832

Email & Skype: info@chipsmall.com Web: www.chipsmall.com

Address: A1208, Overseas Decoration Building, #122 Zhenhua RD., Futian, Shenzhen, China



Chrome DIN Rail Power Supply

24V 91.2W 1 Phase (Class II & NEC Class 2) / DRC-24V100W1A□



*This picture is for reference to DRC-24V100W series only.

CHROME

Highlights & Features

- Protection Class II, Double Isolation (No Earth connection is required)
- Universal AC input voltage and full power up to 55°C
- Power will not de-rate for the entire input voltage range
- Up to 89.0% efficiency @ 230Vac
- NEC Class 2 / Limited Power Source (LPS) certified
- Overvoltage / Overcurrent / Over Temperature Protections

Safety Standards



CB Certified for worldwide use

Model Number:	DRC-24V100W1A□
Unit Weight:	0.35 kg (0.77 lb)
Dimensions (L x W x D):	91.0 x 89.9 x 55.6 mm (3.58 x 3.54 x 2.19 inch)

General Description

The DRC-24V100W1A□ is part of the Chrome DIN Rail Power Supply series, which is designed for use in compact cabinets for home automations and the food and beverage industry. Delta's Chrome DIN Rail Power Supply series offers double isolated input. This means that no Earth connection is required thus resulting in low leakage current. This product provides a universal input voltage range of 90-264Vac, and a wide temperature range of -25°C to 71°C. The Chrome series is certified to safety standard according to IEC/EN/UL 60950-1 Information Technology Equipment (ITE) and UL 508 Industrial Control Equipment (ICE). The series is also fully compliant with RoHS Directive 2011/65/EU for environmental protection. NEC Class 2 and Limited Power Source (LPS) approvals are available for this product.

Model Information

Chrome DIN Rail Power Supply

Model Number	Input Voltage Range	Rated Output Voltage	Rated Output Current
DRC-24V100W1A□	90-264Vac (125-375Vdc)	24Vdc	3.80A

Model Numbering

DR	C -	24V	100W	1	A	□
DIN Rail	Product Series C - Isolation Class II Power Supply	Output Voltage	Output Power (100W series)	Single Phase	No PFC	Z - Black Plastic Case G - Grey Plastic

Chrome DIN Rail Power Supply

24V 91.2W 1 Phase (Class II & NEC Class 2) / DRC-24V100W1A□

Specifications

Input Ratings / Characteristics

Nominal Input Voltage	100-240Vac
Input Voltage Range	90-264Vac
Nominal Input Frequency	50-60Hz
Input Frequency Range	47-63Hz
Nominal DC Input Voltage*	125-250Vdc
DC Input Voltage Range*	125-375Vdc
Input Current	< 2.20A @ 115Vac, < 1.00A @ 230Vac
Efficiency at 100% Load	> 87.0% @ 115Vac, > 89.0% @ 230Vac
Max Inrush Current (Cold Start)	< 30A @ 115Vac, < 60A @ 230Vac
Leakage Current	< 0.25mA @ 240Vac

*Safety approval according to IEC/EN/UL 60950-1.

Output Ratings / Characteristics**

Nominal Output Voltage	24Vdc
Factory Set Point Tolerance	24Vdc \pm 2%
Output Voltage Adjustment Range	22-24Vdc
Output Current	3.80A
Output Power	91.2W
Line Regulation	< 1% typ. (@ 90-264Vac, 100% load)
Load Regulation	< 2% typ. (@ 90-264Vac, 100% load)
Residual Ripple / PARD*** (20MHz)	< 50mVpp / 150mVpp
Rise Time	< 100ms @ nominal input (100% load)
Start-up Time	< 3,000ms @ nominal input (100% load)
Hold-up Time	> 10ms @ 115Vac (100% load) > 30ms @ 230Vac (100% load)
Dynamic Response (Overshoot & Undershoot O/P Voltage)	\pm 5% @ 10-100% load
Start-up with Capacitive Loads	3,000 μ F Max

**For power de-rating from 55°C to 70°C, see power de-rating on page 3.

***PARD is measured with an AC coupling mode, 5cm wires, and in parallel with 0.1 μ F ceramic capacitor & 47 μ F electrolytic capacitor.

Mechanical

Case Cover	Plastic
Dimensions (L x W x D)	91.0 x 89.9 x 55.6 mm (3.58 x 3.54 x 2.19 inch)
Unit Weight	0.35 kg (0.77 lb)
Indicator	Green LED (DC OK)
Cooling System	Convection
Terminal	Input 2 Pins (Rated 300V/25A) Output 4 Pins (Rated 300V/25A)
Wire	Input / Output AWG 22-12 (1 piece), AWG 24-12 (2 pieces)
Mounting Rail	Standard TS35 DIN Rail in accordance with EN 60715

Chrome DIN Rail Power Supply

24V 91.2W 1 Phase (Class II & NEC Class 2) / DRC-24V100W1A□

Environment

Surrounding Air Temperature	Operating	-25°C to +71°C
	Storage	-25°C to +85°C
Power De-rating		> 55°C de-rate power by 2.5% / °C
Operating Humidity		5 to 95% RH (Non-Condensing)
Operating Altitude		0 to 2,000 Meters (6,560 ft.)
Shock Test	Operating	IEC 60068-2-27, Half Sine Wave: 4G for a duration of 22ms, 3 shocks for each 3 directions, 9 times in total
Vibration	Operating	IEC 60068-2-6, Sine Wave: 10-500Hz @ 19.6m/S ² (2G peak); 10 min per cycle, 60 min for all X, Y, Z directions
Pollution Degree		2

Protections

Overvoltage	< 34.8V, SELV Output, Latch Mode
Overload / Overcurrent	> 102~108% of rated load current, Fold Forward Mode (current rises, voltage drops) Auto-recovery when the fault is removed
Over Temperature	> 75°C Surrounding Air Temperature @ 100% load, Latch Mode
Short Circuit	Hicc-up Mode, Non-Latching (Auto-Recovery when the fault is removed)
Internal Fuse	T3.15AH
Degree of Protection	IP20
Protection Against Shock	Class II (No PE* connection is required)

*PE: Primary Earth

Reliability Data

MTBF	Telcordia SR-332	> 500,000 hrs., I/P: 100Vac O/P: 100% load, Ta: 35°C
Expected Cap Life Time		10 years (115Vac & 230Vac, 50% load @ 40°C)

Chrome DIN Rail Power Supply

24V 91.2W 1 Phase (Class II & NEC Class 2) / DRC-24V100W1A□

Safety Standards / Directives

Safety Entry Low Voltage		SELV (EN 60950)
Electrical Safety	TUV Bauart UL/cUL recognized CB scheme	EN 60950-1 UL 60950-1 and CSA C22.2 No. 60950-1 (File No. E131881) IEC 60950-1, Limited Power Source (LPS)
Industrial Control Equipment	UL/cUL listed	UL 508 and CSA C22.2 No. 107.1-01 (File No. E338991)
Class 2 Power Supply	UL/cUL recognized	UL 60950-1 and CSA C22.2 No. 60950-1 (File No. E131881)
CE		In conformance with EMC Directive 2014/30/EU and Low Voltage Directive 2014/35/EU
Material and Parts		RoHS Directive 2011/65/EU Compliant
Galvanic Isolation	Input to Output	3.0KVac

EMC

EMC / Emissions		CISPR 22, EN 55022, FCC Title 47: Class B
Immunity to		EN 55024
Electrostatic Discharge	IEC 61000-4-2	Level 3 Criteria A ¹⁾ Air Discharge: 8kV Contact Discharge: 4kV
Radiated Field	IEC 61000-4-3	Level 2 Criteria A ¹⁾ 80MHz-1GHz, 3V/M with 1kHz tone / 80% modulation
Electrical Fast Transient / Burst	IEC 61000-4-4	Level 3 Criteria A ¹⁾ 1kV
Surge	IEC 61000-4-5	Level 3 Criteria A ¹⁾ Differential Mode ²⁾ : 1kV
Conducted	IEC 61000-4-6	Level 2 Criteria A ¹⁾ 150kHz-80MHz, 3Vrms
Power Frequency Magnetic Fields	IEC 61000-4-8	Criteria A ¹⁾ 1A/Meter
Voltage Dips and Interruptions	IEC 61000-4-11	> 95% dip; 0.5 cycle (10ms)
Harmonic Current Emission		IEC/EN 61000-3-2, Class A
Voltage Fluctuation and Flicker		IEC/EN 61000-3-3

1) Criteria A: Normal performance within the specification limits

2) Symmetrical: Differential mode (Line to line)

Chrome DIN Rail Power Supply

24V 91.2W 1 Phase (Class II & NEC Class 2) / DRC-24V100W1A□

Block Diagram

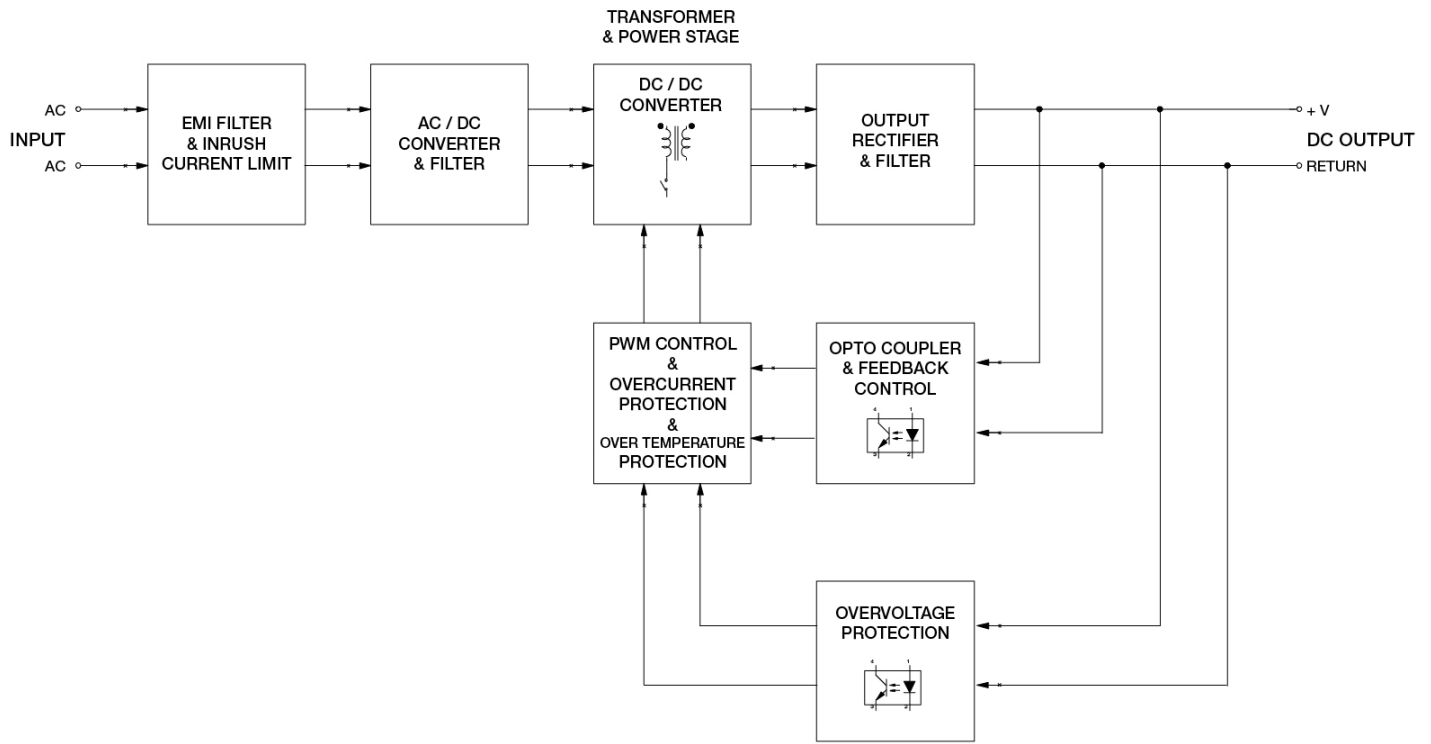

Device Description

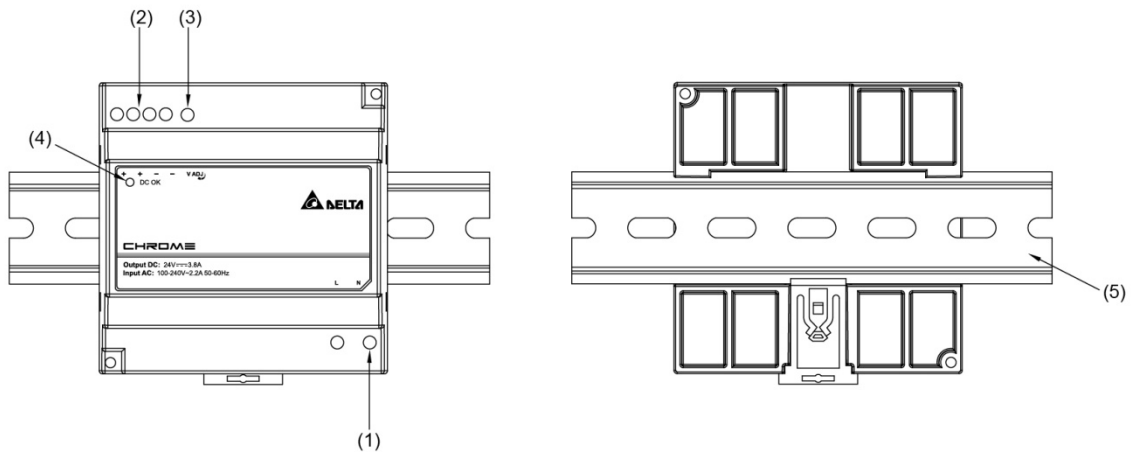

- 1) Input terminal block connector
- 2) Output terminal block connector
- 3) DC voltage adjustment potentiometer
- 4) DC OK control LED (Green)
- 5) Universal mounting system

Chrome DIN Rail Power Supply

24V 91.2W 1 Phase (Class II & NEC Class 2) / DRC-24V100W1A□

Dimensions

L x W x D: 91.0 x 89.9 x 55.6 mm (3.58 x 3.54 x 2.19 inch)

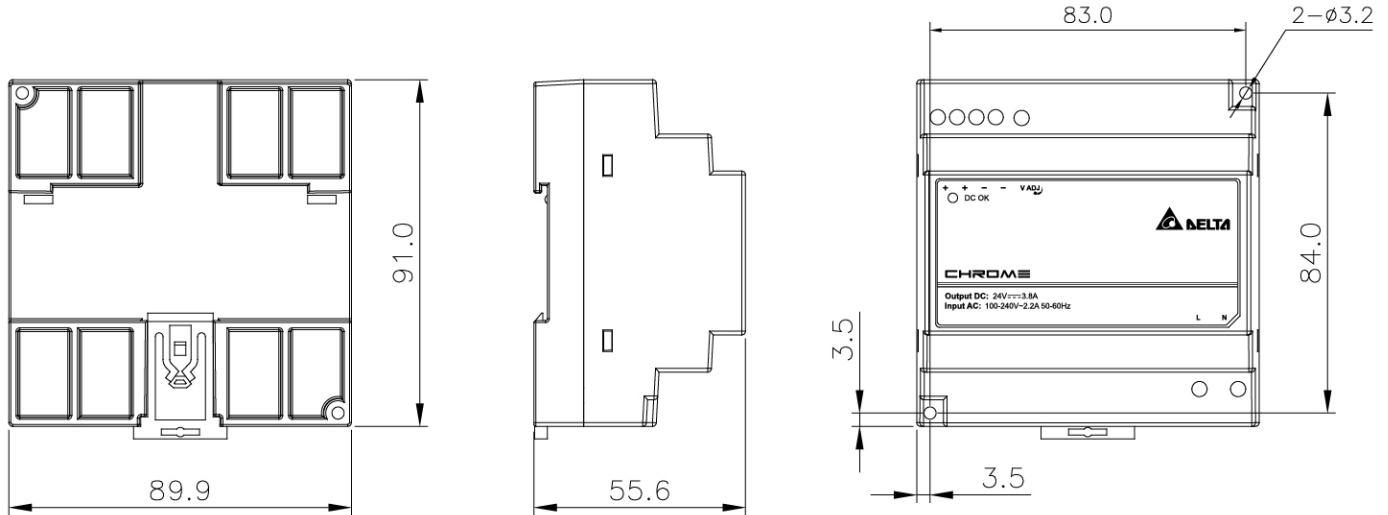

Engineering Data

Output Load De-rating VS Surrounding Air Temperature

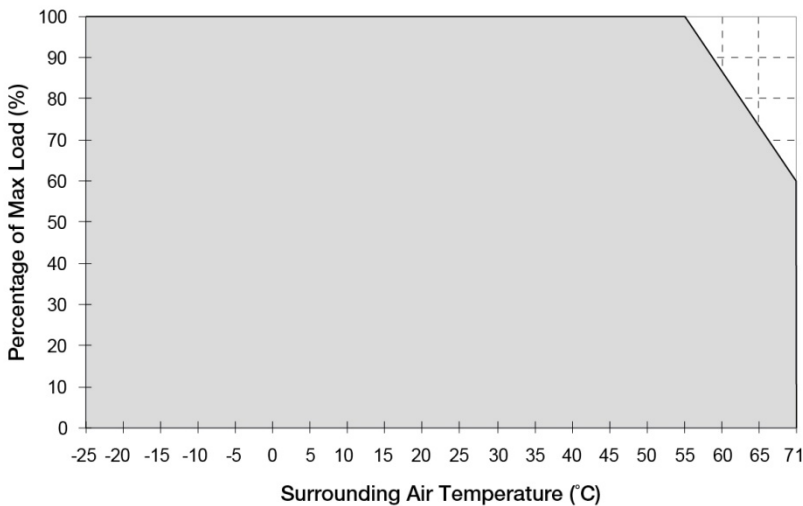

Fig. 1 De-rating for Vertical Mounting Orientation
 > 55°C de-rate power by 2.5% / °C

Note

1. Power supply components may degrade, or be damaged, when the power supply is continuously used outside the shaded region, refer to the graph shown in Fig. 1.
2. If the output capacity is not reduced when the surrounding air temperature >55°C, the device will run into Over Temperature Protection. When activated, power supply will latch off, until the surrounding air temperature is lowered or the load is reduced as far as necessary to keep the device in working condition, and require removal/re-application of input AC voltage in order to restart.
3. In order for the device to function in the manner intended, it is also necessary to keep a safety distance of 50mm (1.97 inch) above and below the device as well as a lateral distance of 25mm (0.98 inch) to other units while the device is in operation.
4. Depending on the surrounding air temperature and output load delivered by the power supply, the device can be very hot!
5. If the device has to be mounted in any other orientation, please contact info@deltapsu.com for more details.

Chrome DIN Rail Power Supply

24V 91.2W 1 Phase (Class II & NEC Class 2) / DRC-24V100W1A□

Output Load De-rating VS Input Voltage

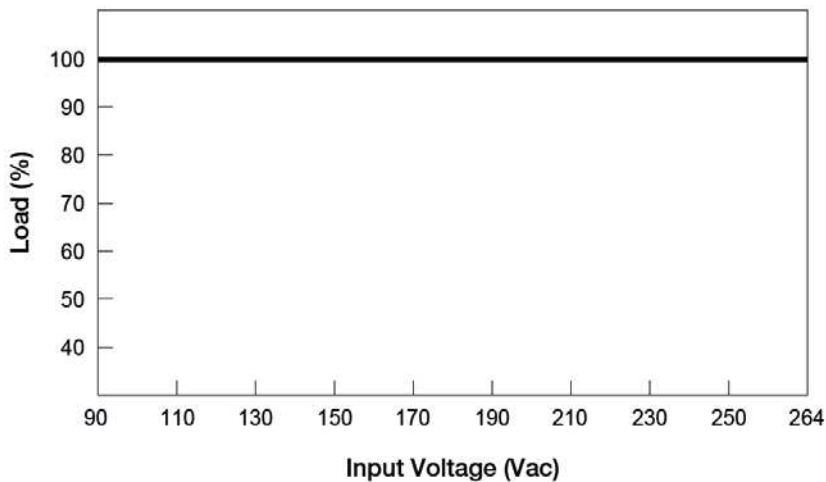

■ No output power de-rating across the entire input voltage range

Assembly & Installation

The power supply unit (PSU) can be mounted on 35mm DIN rails in accordance with EN 60715. The device should be installed with input terminal block at the bottom.

Each device is delivered ready to install.

Mounting

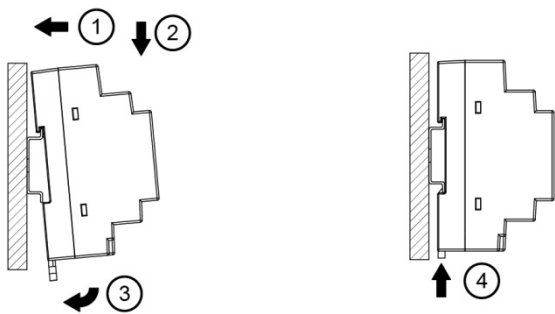

Fig. 2.1 Mounting

Snap on the DIN rail as shown in Fig. 2.1:

1. Tilt the unit upwards and insert it onto the DIN rail.
2. Push downwards until stopped.
3. Press against the bottom front side for locking.
4. Shake the unit slightly to ensure that it is secured.

Dismounting

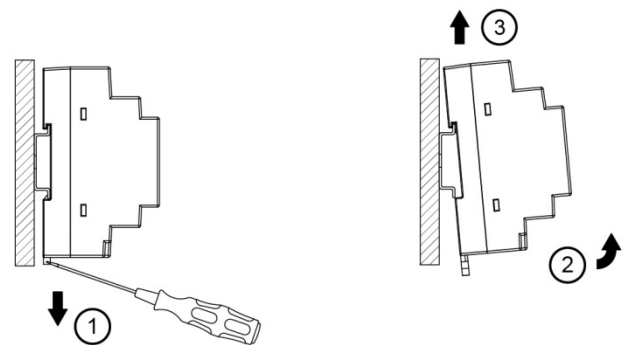

Fig. 2.2 Dismounting

To uninstall, pull or slide down the latch with screw driver as shown in Fig. 2.2. Then slide the power supply unit (PSU) in the opposite direction, release the latch and pull out the power supply unit (PSU) from the rail.

Chrome DIN Rail Power Supply

24V 91.2W 1 Phase (Class II & NEC Class 2) / DRC-24V100W1A□

Safety Instructions

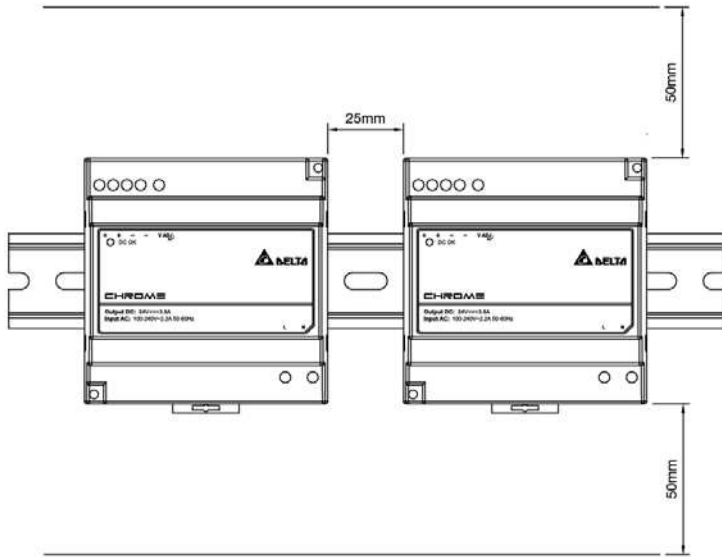

- ALWAYS switch mains of input power OFF before connecting and disconnecting the input voltage to the unit. If mains are not turned OFF, there is risk of explosion / severe damage.
- **To guarantee sufficient convection cooling, keep a distance of 50mm (1.97 inch) above and below the device as well as a lateral distance of 25mm (0.98 inch) to other units.**
- Note that the enclosure of the device can become very hot depending on the surrounding air temperature and load of the power supply. Risk of burns!
- DO NOT insert any objects into the unit.
- Hazardous voltages may be present for up to 5 minutes after the input mains voltage is disconnected. Do not touch the unit during this time.
- The power supplies unit should be installed in minimum IP54 rated enclosure.
- The power supplies are built in units and must be installed in a cabinet or room (condensation free environment and indoor location) that is relatively free of conductive contaminants.

Functions

■ Graph illustrating the Start-up Time, Rise Time, and Hold-up Time

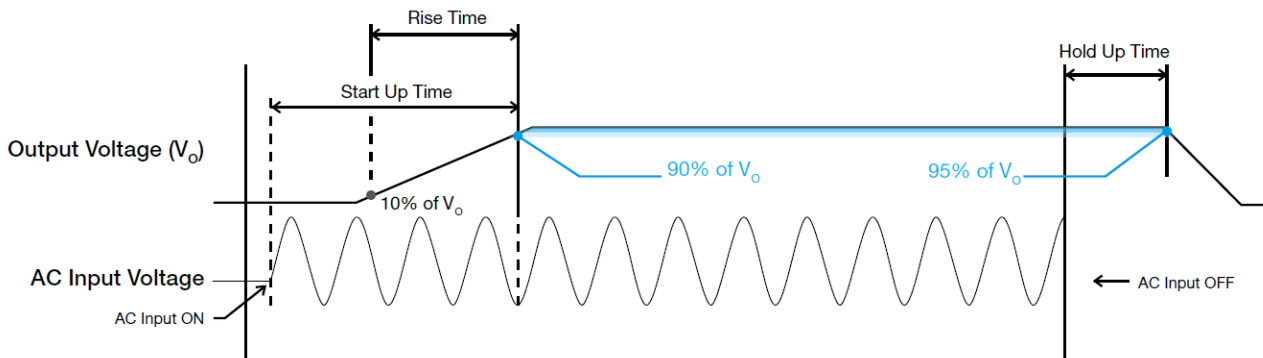

Start-up Time

The time required for the output voltage to reach 90% of its final steady state set value, after the input voltage is applied.

Rise Time

The time required for the output voltage to change from 10% to 90% of its final steady state set value.

Hold-up Time

Time between the collapse of the AC input voltage, and the output falling to 95% of its steady state set value.

Chrome DIN Rail Power Supply

24V 91.2W 1 Phase (Class II & NEC Class 2) / DRC-24V100W1A□

Inrush Current

Inrush current is the peak, instantaneous, input current measured and, occurs when the input voltage is first applied. For AC input voltages, the maximum peak value of inrush current will occur during the first half cycle of the applied AC voltage. This peak value decreases exponentially during subsequent cycles of AC voltage.

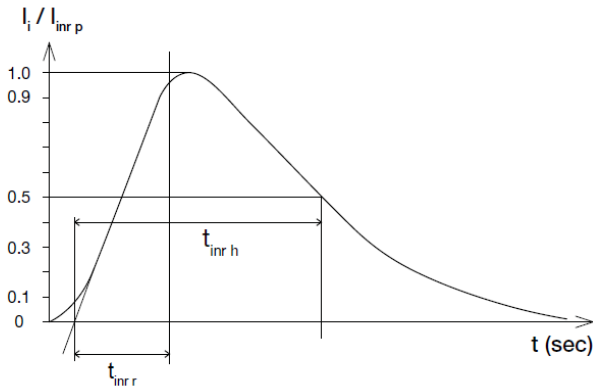

Dynamic Response

The power supply output voltage will remain within $\pm 5\%$ of its steady state value, when subjected to a dynamic load from 10 to 100% of its rated current.

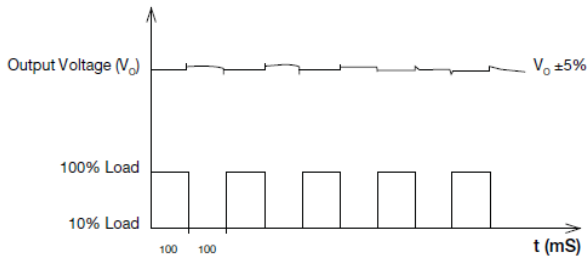

Overvoltage Protection (Latch Mode)

The power supply's overvoltage circuit will be activated when its internal feedback circuit fails. The output voltage shall not exceed its specifications defined on Page 3 under "Protections". Power supply will latch off, and require removal/re-application of input AC voltage in order to restart.

The power supply should be latch.

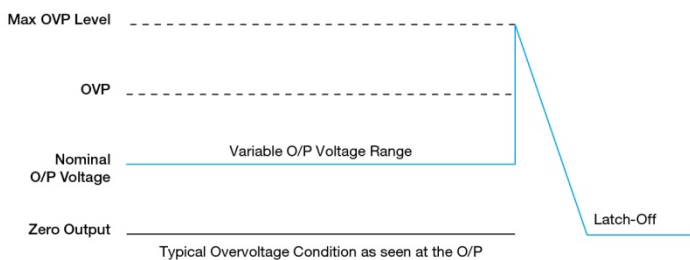

Overload & Overcurrent Protections (Auto-Recovery)

The power supply's Overload (OLP) and Over current (OCP) Protections will be activated when output current is $3.8A I_o$ (Max load) $< 5.7A$. In such occurrence, the V_o will start to droop and once the output voltage is below 13Vdc typ., the power supply will go into "Hiccup mode" (Auto-Recovery). The power supply will recover once the fault condition of the OLP and OCP is removed and I_o is back within the specifications.

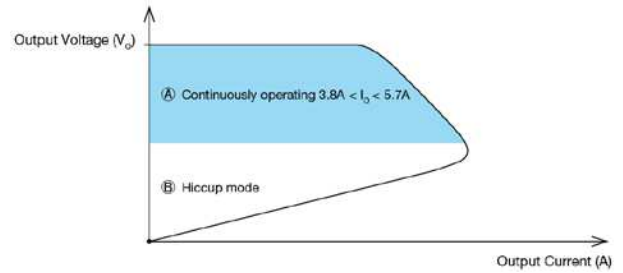

Additionally, if the I_o is $>102\sim 108\%$ for a prolonged period of time (depending on the load), the Over Temperature Protection (OTP) will be activated due to high temperature on critical components. The power supply will then go into "Latch mode" until the PSU cools down and the AC power is recycled.

Over Temperature Protection (Latch Mode)

As described in load de-rating section, the power supply also has Over Temperature Protection (OTP). In the event of a higher operating temperature at 100% load; or, when the operating temperature is beyond what is recommended in the de-rating graph, the OTP circuit will be activated. When activated, power supply will latch off, until the surrounding air temperature drops to its normal operating temperature or the load is reduced as recommended in the de-rating graph. Removal/re-application of input AC voltage will then be required in order to restart.

Short Circuit Protection (Auto-Recovery)

The power supply's output Short Circuit Protection function also provides protection against short circuits. When a short circuit is applied, the output current will operate in "Hiccup mode". The power supply will return to normal operation after the short circuit is removed.

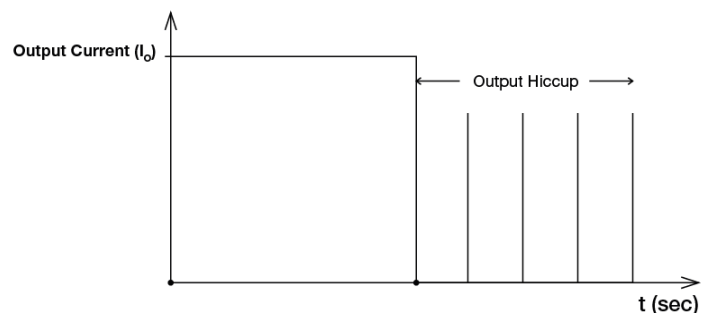

Chrome DIN Rail Power Supply

24V 91.2W 1 Phase (Class II & NEC Class 2) / DRC-24V100W1A □

Operating Mode

■ Redundant Operation

In order to ensure proper redundant operation for the power supply units (PSUs), the output voltage difference between the two units must be kept at 0.45~0.50V for these 24V supplies. Follow simple steps given below to set them up for the redundant operation:

Step 1.

Measure output voltage of PSU 1 and PSU 2. If PSU 1 is the master unit, then V_O of PSU 1 must be higher than PSU 2. In order to set the output voltage, individually connect each power supply to 50% of rated load at any line voltage from 85-264Vac, and set the PSU 1 and PSU 2 output voltage.

Step 2.

Connect the power supply units PSU 1 and PSU 2 to Vin 1 & Vin 2, respectively, of the DRR-20N (or 20A) module shown on the right of above diagram.

Step 3.

Connect the system load to V_{out} . Please note that output voltage V_{out} from DRR module will be = V_O (output voltage of power supply) – V_{drop}^* (in DRR module).

* V_{drop} will vary from 0.60V to 0.90V (Typical 0.65V) depending on the load current and surrounding air temperature.

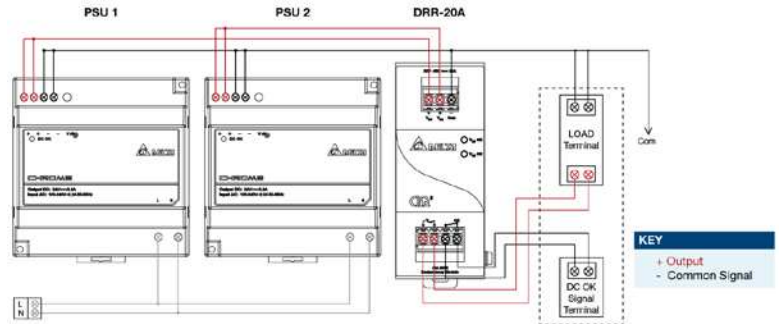

Fig. 3 Redundancy Operation Connection Diagram

■ Parallel Operation

The power supply units (PSUs) can also be used for parallel operation in order to increase the output power. The difference in output voltage between the two units must be kept to within 25mV of each other. This difference must be verified with the same output load connected independently to each unit.

Parameters such as EMI, inrush current, leakage current, PARD, start up time will be different from those on the datasheet, when two units are connected in parallel. The user will need to verify that any differences will still allow the two power supplies connected in parallel will work properly in their product/application.

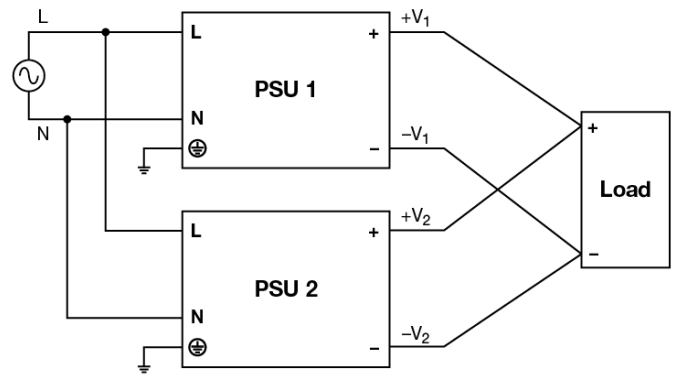

Fig. 4 Parallel Operation Connection Diagram

Chrome DIN Rail Power Supply

24V 91.2W 1 Phase (Class II & NEC Class 2) / DRC-24V100W1A□

Others

Delta RoHS Compliant



Restriction of the usage of hazardous substances

The European directive 2011/65/EU limits the maximum impurity level of homogeneous materials such as lead, mercury, cadmium, chrome, polybrominated flame retardants PBB and PBDE for the use in electrical and electronic equipment. RoHS is the abbreviation for “Restriction of the use of certain hazardous substances in electrical and electronic equipment”.

This product conforms to this standard.

PFC – Norm EN 61000-3-2

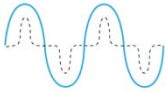

Line Current Harmonic content

Typically, the input current waveform is not sinusoidal due to the periodical peak charging of the input capacitor. In industrial environment, complying with EN 61000-3-2 is only necessary under special conditions. Complying to this standard can have some technical drawbacks, such as lower efficiency as well as some commercial aspects such as higher purchasing costs. Frequently, the user does not profit from fulfilling this standard, therefore, it is important to know whether it is mandatory to meet this standard for a specific application.