



Chipsmall Limited consists of a professional team with an average of over 10 year of expertise in the distribution of electronic components. Based in Hongkong, we have already established firm and mutual-benefit business relationships with customers from,Europe,America and south Asia,supplying obsolete and hard-to-find components to meet their specific needs.

With the principle of “Quality Parts,Customers Priority,Honest Operation,and Considerate Service”,our business mainly focus on the distribution of electronic components. Line cards we deal with include Microchip,ALPS,ROHM,Xilinx,Pulse,ON,Everlight and Freescale. Main products comprise IC,Modules,Potentiometer,IC Socket,Relay,Connector.Our parts cover such applications as commercial,industrial, and automotives areas.

We are looking forward to setting up business relationship with you and hope to provide you with the best service and solution. Let us make a better world for our industry!



## Contact us

Tel: +86-755-8981 8866 Fax: +86-755-8427 6832

Email & Skype: info@chipsmall.com Web: www.chipsmall.com

Address: A1208, Overseas Decoration Building, #122 Zhenhua RD., Futian, Shenzhen, China



# Multiphase Spread-Spectrum EconOscillator

**DS1094L**

## General Description

The DS1094L is a silicon oscillator that generates four multiphase, spread-spectrum, square-wave outputs. Frequencies between 2MHz and 31.25kHz can be output in either two, three, or four-phase mode. The internal master oscillator can be dithered by either 0, 2, 4, or 8% to reduce the amount of peak spectral energy at the fundamental and harmonic clock frequencies. This significantly reduces the amount of electromagnetic interference (EMI) radiation that is generated at the system level. The DS1094L is ideally suited as a clock generator for switched-mode power supplies. The outputs generated by the DS1094L are used by DC-DC circuitry to efficiently shift voltages either up or down. The DS1094L can be programmed using the I<sup>2</sup>C-compatible, 2-wire serial interface to select the output frequency, number of clock phases, and dither rate, or optionally it can be shipped from the factory custom programmed.

## Applications

- Switch-Mode Power Supplies
- Servers
- Printers
- Automotive Telematics and Infotainment

## Features

- ◆ EconOscillator™ with Two, Three, or Four Phase Outputs
- ◆ Ideally Suited as the Clock Generator for Switch-Mode Power Supplies
- ◆ Output Frequencies Programmable from 2MHz to 31.25kHz
- ◆ Dithered Output Significantly Reduces EMI Emissions
- ◆ No External Timing Components Required
- ◆ Nonvolatile (NV) Configuration Settings
- ◆ User-Programmable—Factory Programmed Options Available
- ◆ Operating Temperature Range: -40°C to +85°C

## Ordering Information

PART	TEMP RANGE	PIN-PACKAGE
DS1094LU	-40°C to +85°C	8 μSOP

## Typical Operating Circuit

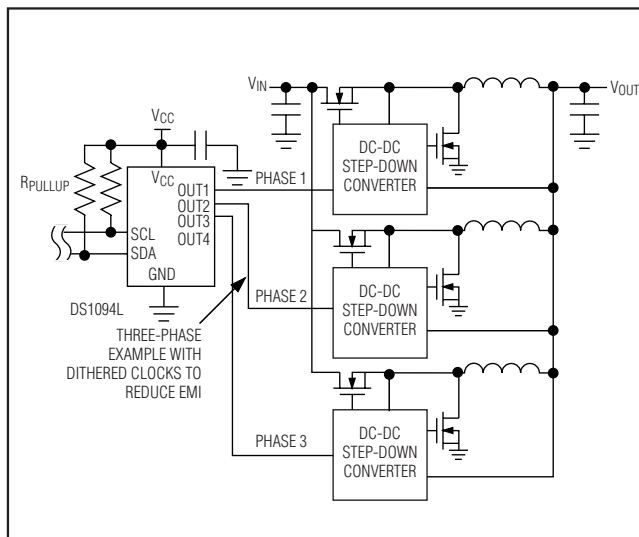

EconOscillator is a trademark of Dallas Semiconductor.

## Pin Configuration

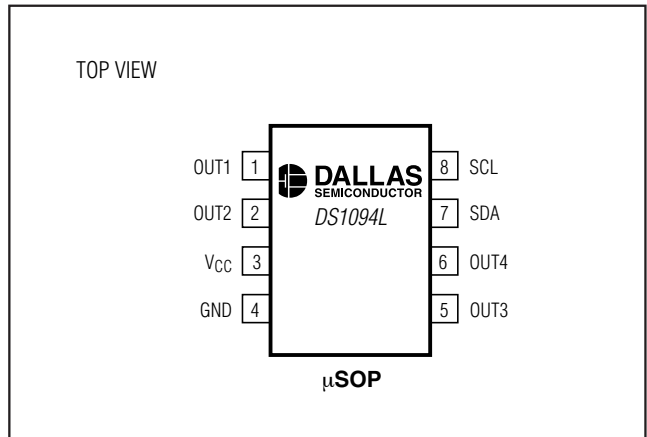

# Multiphase Spread-Spectrum EconOscillator

## ABSOLUTE MAXIMUM RATINGS

Voltage Range on V<sub>CC</sub>, SDA, and SCL

Relative to Ground.....-0.5V to +6.0V

Operating Temperature Range .....-40°C to +85°C

EEPROM Programming Temperature Range .....0°C to +70°C

Storage Temperature Range .....-55°C to +125°C

Soldering Temperature .....See IPC/JEDEC

J-STD-020A Specification

*Stresses beyond those listed under "Absolute Maximum Ratings" may cause permanent damage to the device. These are stress ratings only, and functional operation of the device at these or any other conditions beyond those indicated in the operational sections of the specifications is not implied. Exposure to absolute maximum rating conditions for extended periods may affect device reliability.*

## RECOMMENDED DC OPERATING CONDITIONS

(T<sub>A</sub> = -40°C to +85°C)

PARAMETER	SYMBOL	CONDITIONS	MIN	TYP	MAX	UNITS
Supply Voltage	V <sub>CC</sub>	(Note 1)	3.0		3.6	V
Input Logic 1 (SDA, SCL)	V <sub>IH</sub>		0.7 x V <sub>CC</sub>		V <sub>CC</sub> + 0.3	V
Input Logic 0 (SDA, SCL)	V <sub>IL</sub>		-0.3		+0.3 x V <sub>CC</sub>	V

## DC ELECTRICAL CHARACTERISTICS

(V<sub>CC</sub> = +3.0 to 3.6V, T<sub>A</sub> = -40°C to +85°C, unless otherwise noted.)

PARAMETER	SYMBOL	CONDITIONS	MIN	TYP	MAX	UNITS
Active Supply Current	I <sub>CC</sub>	C <sub>L</sub> = 15pF per output, SDA = SCL = V <sub>CC</sub>		1.4	3	mA
High-Level Output Voltage (OUT1-4)	V <sub>OH</sub>	I <sub>OH</sub> = -4mA; V <sub>CC</sub> = min	2.4			V
Low-Level Output Voltage (OUT1-4)	V <sub>OL</sub>	I <sub>OL</sub> = 3.5mA			0.4	V
Low-Level Output Voltage (SDA)	V <sub>OL</sub>	3mA sink current			0.4	V
		6mA sink current			0.6	
High-Level Input Current (SDA, SCL)	I <sub>IH</sub>	V <sub>IH</sub> = V <sub>CC</sub>			+1.0	μA
Low-Level Input Current (SDA, SCL)	I <sub>IL</sub>	V <sub>IL</sub> = 0.0V	-1.0			μA

# Multiphase Spread-Spectrum EconOscillator

DS1094L

## AC ELECTRICAL CHARACTERISTICS

( $V_{CC} = +3.0V$  to  $3.6V$ ,  $T_A = -40^{\circ}C$  to  $+85^{\circ}C$ , unless otherwise noted.)

PARAMETER	SYMBOL	CONDITIONS	MIN	TYP	MAX	UNITS
Master Oscillator Frequency	$f_{MOSC}$		1		2	MHz
Output Frequency Tolerance	$\Delta f_{OUT}$	$V_{CC} = 3.3V$ , $T_A = +25^{\circ}C$ (Note 8)	-2.5		+2.5	%
Voltage Frequency Variation	$\Delta f_{OUT}$	$T_A = +25^{\circ}C$ (Note 2)	-0.5		+0.5	%
Temperature Frequency Variation	$\Delta f_{OUT}$	$V_{CC} = 3.3V$ (Note 2)	0 to $+70^{\circ}C$	-1.1	+1.1	%
			$-40^{\circ}C$ to $+85^{\circ}C$	-2.5	+1.1	
DAC Step Size			-0.75		+0.75	%
Peak-to-Peak Jitter ( $3\sigma$ )		P1:P0 = 11 (Note 3)		8		%
Load Capacitance	$C_L$			15	50	pF
Output Duty Cycle (Note 4)		2 Phase		50		%
		3 Phase		33.3		
		4 Phase		50		
Power-Up Time	$t_{POR} + t_{STAB}$	(Note 5)		0.1	0.5	ms

## AC ELECTRICAL CHARACTERISTICS (See Figure 3)

( $V_{CC} = +3.0V$  to  $3.6V$ ,  $T_A = -40^{\circ}C$  to  $+85^{\circ}C$ , unless otherwise noted. Timing referenced to  $V_{IL(MAX)}$  and  $V_{IH(MIN)}$ .)

PARAMETER	SYMBOL	CONDITIONS	MIN	TYP	MAX	UNITS
SCL Clock Frequency	$f_{SCL}$	(Note 6)	0		400	kHz
Bus Free Time Between Stop and Start Conditions	$t_{BUF}$		1.3			$\mu s$
Hold Time (Repeated) Start Condition	$t_{HD:STA}$		0.6			$\mu s$
Low Period of SCL	$t_{LOW}$		1.3			$\mu s$
High Period of SCL	$t_{HIGH}$		0.6			$\mu s$
Data Hold Time	$t_{HD:DAT}$		0		0.9	$\mu s$
Data Setup Time	$t_{SU:DAT}$		100			ns
Start Setup time	$t_{SU:STA}$		0.6			$\mu s$
SDA and SCL Rise Time	$t_R$	(Note 7)	20 + $0.1C_B$		300	ns
SDA and SCL Fall Time	$t_F$	(Note 7)	20 + $0.1C_B$		300	ns
Stop Setup Time	$t_{SU:STO}$		0.6			$\mu s$
SDA and SCL Capacitive Loading	$C_B$	(Note 7)			400	pF
EEPROM Write Time	$t_{WR}$			5	10	ms
Input Capacitance	$C_I$			5		pF



# Multiphase Spread-Spectrum EconOscillator

## NONVOLATILE MEMORY CHARACTERISTICS

(VCC = +3.0V to 3.6V, unless otherwise noted.)

PARAMETER	SYMBOL	CONDITIONS	MIN	TYP	MAX	UNITS
EEPROM Writes		+70°C (Note 4)	10,000			

**Note 1:** All voltages referenced to ground.

**Note 2:** This is the change observed in output frequency due to changes in temperature or voltage.

**Note 3:** This is a percentage of the output period. Parameter is characterized but not production tested. This can be varied from 2%, 4%, or 8%.

**Note 4:** This parameter is guaranteed by design.

**Note 5:** This indicates the time between power-up and the outputs becoming active. An on-chip delay is intentionally introduced to allow the oscillator to stabilize.  $t_{STAB}$  is equivalent to approximately 64  $f_{MOSC}$  cycles and, hence, will depend on the programmed clock frequency.

**Note 6:** Timing shown is for fast-mode (400kHz) operation. This device is also backward compatible with I<sup>2</sup>C standard-mode timing.

**Note 7:** CB—total capacitance of one bus line in picofarads.

**Note 8:** Typical frequency shift due to aging is  $\pm 0.5\%$ . Aging stressing includes Level 1 moisture reflow preconditioning (24hr +125°C bake, 168hr 85°C/85%RH moisture soak, and 3 solder reflow passes +240 +0/-5°C peak) followed by 1000hr max VCC biased 125°C HTOL, 1000 temperature cycles at -55°C to +125°C, and 168hr 121°C/2 ATM Steam/Unbiased Autoclave.

## Typical Operating Characteristics

(VCC = +3.3V, T<sub>A</sub> = +25°C, unless otherwise noted.)

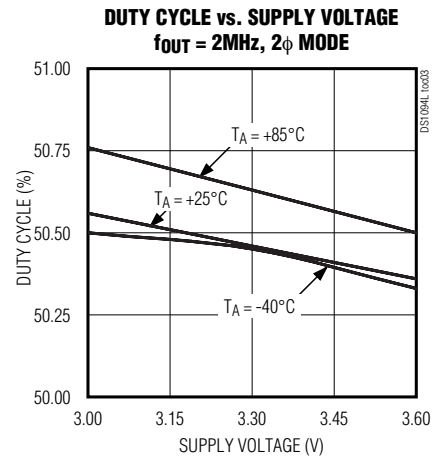
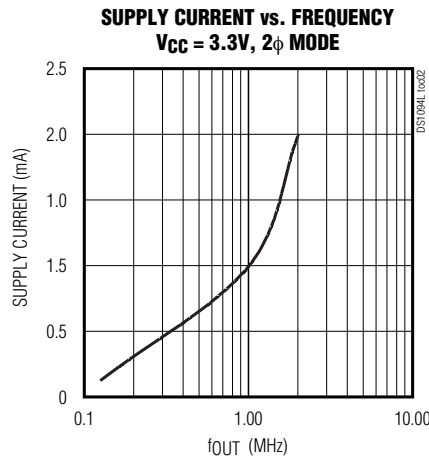
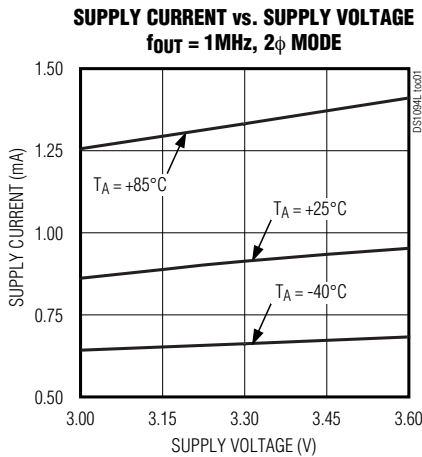

# Multiphase Spread-Spectrum EconOscillator

DS1094L

## Typical Operating Characteristics (continued)

( $V_{CC} = +3.3V$ ,  $T_A = +25^\circ C$ , unless otherwise noted.)

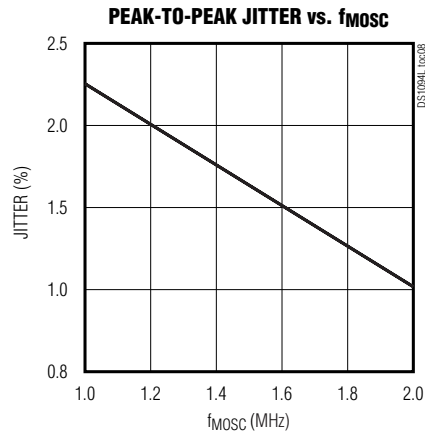
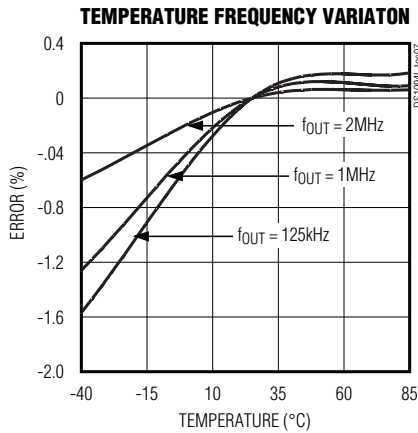
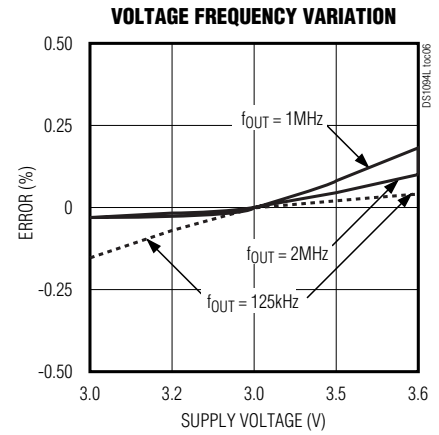
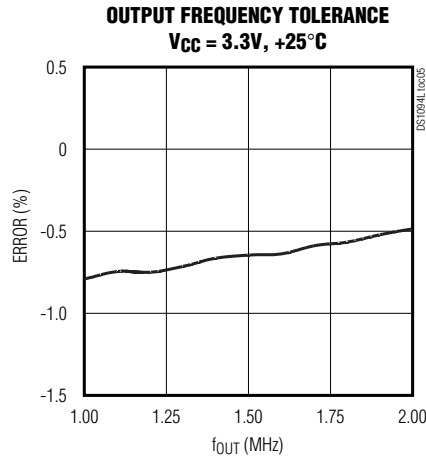
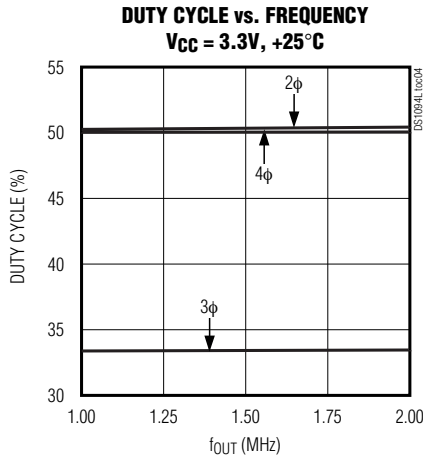

## Pin Description

PIN	NAME	FUNCTION
1	OUT1	Oscillator Output 1
2	OUT2	Oscillator Output 2
3	$V_{CC}$	Positive Supply Terminal
4	GND	Ground
5	OUT3	Oscillator Output 3
6	OUT4	Oscillator Output 4
7	SDA	2-Wire Serial-Interface Data Input/Output
8	SCL	2-Wire Serial-Interface Clock Input

# Multiphase Spread-Spectrum EconOscillator

## Functional Diagram

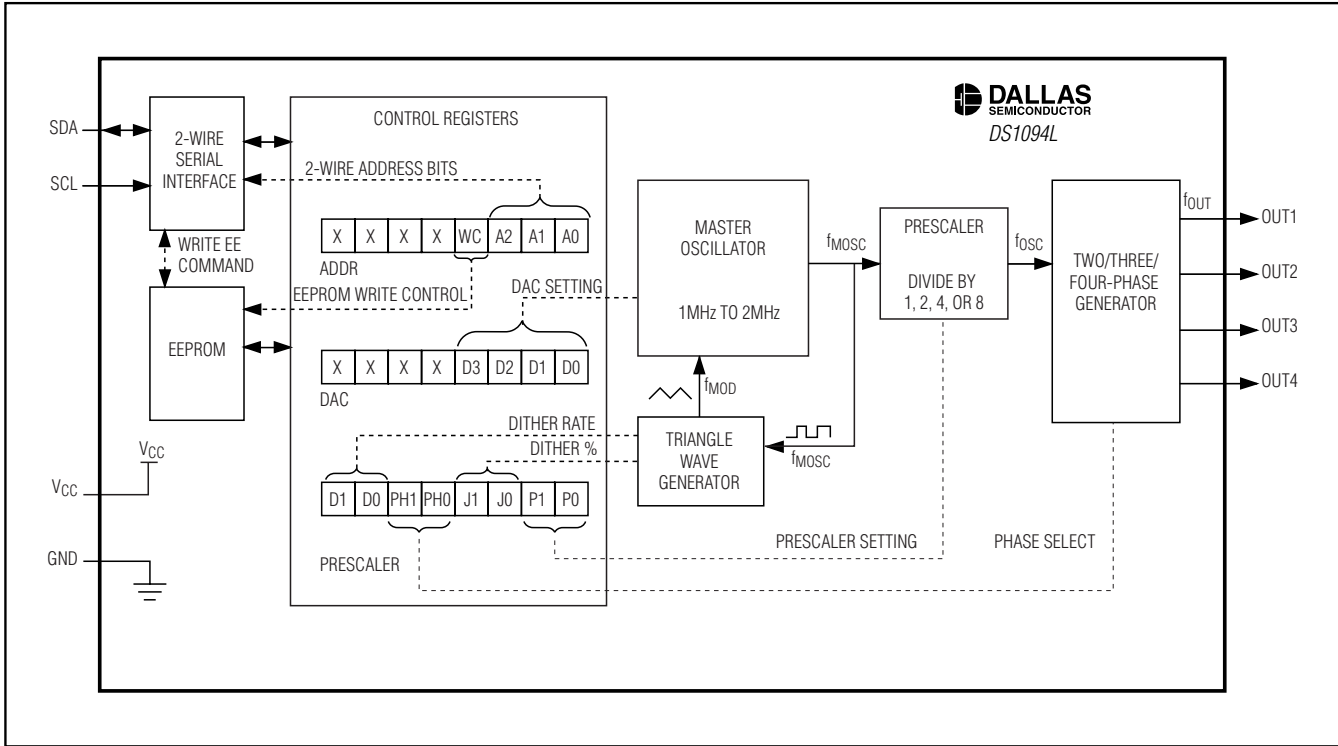

### Detailed Description

The DS1094L consists of a master oscillator, prescaler, phase generator, and triangle-wave generator (used to dither the master oscillator), which are all programmable using the 2-wire interface and stored in NV memory.

#### Master Oscillator

The master oscillator is responsible for generating the timing (frequency) of the outputs. The master oscillator frequency,  $f_{MOSC}$ , can be programmed anywhere between 1MHz to 2MHz in 100kHz steps. The master oscillator is programmed using the DAC register. The four MSBs of the DAC register are don't cares, while the four

LSBs (D3 to D0) are the DAC value. The master oscillator frequency is determined using the following equation:

$$f_{MOSC} = 1\text{MHz} + (\text{DAC value} \times 100\text{kHz})$$

Valid values for DAC are 0 to 10 (dec). DAC values greater than 10 exceed the 2MHz limit and are not permitted.

The master oscillator also determines the spread-spectrum dither frequency. This is described in the *Triangle Wave Generator* section.

**Table 1. Master Oscillator Settings**

DAC VALUE (dec)	DAC REGISTER	$f_{MOSC}$
0	00h	1.0MHz
1	01h	1.1MHz
2	02h	1.2MHz
—	—	—
10	0Ah	2.0MHz
11 to 15	0Bh to 0Fh	Reserved

**Table 2. Prescaler Settings**

BITS P1, P0	DIVISOR	$f_{OSC} =$
00	$2^0$	$f_{MOSC}/1$
01	$2^1$	$f_{MOSC}/2$
10	$2^2$	$f_{MOSC}/4$
11	$2^3$	$f_{MOSC}/8$

# Multiphase Spread-Spectrum EconOscillator

**Table 3. Phase Generator Settings**

BITS Ph1, Ph0	MODE
00	Two-Phase
01	Three-Phase
10	Four-Phase
11	Reserved

**Table 4. Dither Amount Settings**

BITS J1, J0	DITHER AMOUNT*
00	0%
01	2%
10	4%
11	8%

\*The frequency is dithered down from the programmed value of  $f_{MOSC}$ .

**Table 5. Dither Frequency Settings**

BITS D1, D0	DITHER FREQUENCY
00	$f_{MOSC}/128$
01	$f_{MOSC}/256$
10	$f_{MOSC}/512$
11	$f_{MOSC}/1024$

### Prescaler

The prescaler divides the master oscillator frequency,  $f_{MOSC}$ , by 1, 2, 4, or 8. The resultant frequency,  $f_{OSC}$ , is calculated using the following formula:

$$f_{OSC} = f_{MOSC} / 2^{PRESCALER}$$

where PRESCALER can be 0 to 3. The prescaler is configured using bits P1 and P0 in the PRESCALER register. Valid settings are shown in Table 2. The location of bits P1 and P0 in the PRESCALER register is shown in the *Control Registers* section.

Note that the PRESCALER register also contains bits controlling other features of the device (dither amount, dither rate, and phase).

### Phase Generator

The four oscillator outputs (OUT1 to OUT4) can be configured in either two-phase, three-phase, or four-phase mode. The output waveforms of each mode are illustrated in Figure 1. Likewise, the figure also shows a comparison of  $f_{OUT}$ , the duty cycle, and the output phase shifts between the three modes. Bits Ph1 and Ph0 in the PRESCALER register are used to select the desired mode (see Table 3). The location of bits Ph1

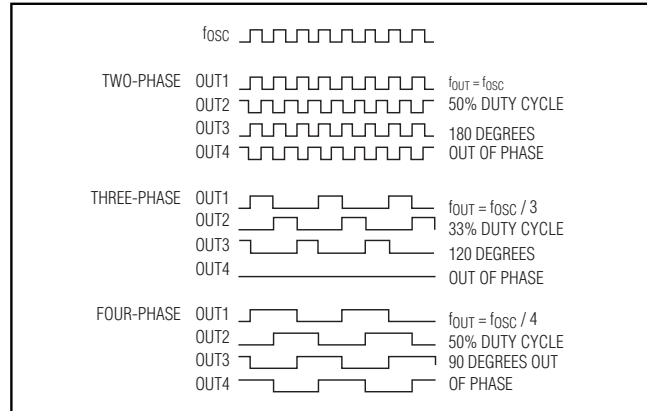

Figure 1. DS1094L Output Waveforms

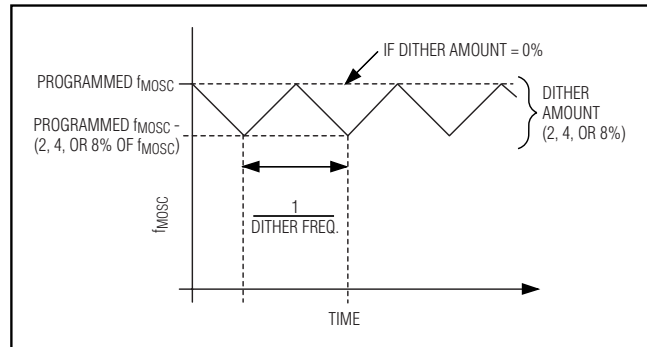

Figure 2. DS1094L Dither Waveform

and Ph0 in the PRESCALER register is shown in the *Control Registers* section.

### Triangle Wave Generator

The triangle wave generator is used to dither the master oscillator frequency, adding spread-spectrum functionality to the DS1094L by injecting an offset element into the master oscillator. Both the dither amount (%) and dither frequency are programmable. The dither amount is controlled by bits J1 and J0 in the PRESCALER register. The dither frequency is controlled by bits D1 and D0, also in the PRESCALER register. The bit settings are shown in Table 4 and 5. The location of bits J1, J0, D1, and D0 in the PRESCALER register is shown in the *Control Registers* section.

When dither is enabled (by selecting a percentage other than 0%), the master oscillator frequency,  $f_{MOSC}$ , is dithered between the programmed  $f_{MOSC}$  and the selected percentage down from the programmed  $f_{MOSC}$  (see Figure 2). For example, if  $f_{MOSC}$  is programmed to 2MHz (DAC register = 0Ah) and the dither amount is programmed to 2%, the frequency of  $f_{MOSC}$



# Multiphase Spread-Spectrum EconOscillator

will dither between 2MHz and 1.96MHz at a modulation frequency determined by the selected dither frequency. Continuing with the same example, if D1 and D0 both equal zero, selecting  $f_{MOSC}/128$ , then the dither frequency would be 15.625kHz.

## 2-Wire Slave Address

The 2-wire serial interface is used to read and write the control registers of the DS1094L. The default slave address of the DS1094L is B0h (see Figure 4). Using the 3 address bits (A2, A1, and A0) in the ADDR register, the slave address can be changed to allow as many as eight DS1094Ls reside on the same 2-wire bus or to simply prevent address conflicts with other 2-wire devices. The location of the address bits within the ADDR register is shown in the *Control Registers* section. A detailed description of the 2-wire interface is found in the *2-Wire Serial Interface Description* section.

## EEPROM Write Control

Since EEPROM does have a limited number of lifetime write cycles (specified in the *NONVOLATILE MEMORY CHARACTERISTICS* electrical table), it is possible to configure the DS1094L to prevent EEPROM wear out and eliminate the EEPROM write cycle time by using the WC bit in the ADDR register. When the WC bit is 0 (default), register writes are automatically written into EEPROM. The Write EE Command is not needed. However, if WC = 1, then register writes are stored in SRAM and only written to EEPROM when the user sends the Write EE Command. If power to the device is cycled, the last value stored in EEPROM is recalled. The time required to store the values is one EEPROM write cycle time. WC = 1 is ideal for applications that frequently modify the frequency/registers.

Regardless of the value of the WC bit, the value of the ADDR register is always written immediately to EEPROM.

## Control Registers

The DS1094L control registers are used to program the frequency and features of the device. Table 6 lists the

**Table 6. Control Registers**

REGISTER	ADDRESS	BINARY								DEFAULT	ACCESS
		MSB				LSB					
PRESCALER	02h	D1	D0	Ph1	Ph0	J1	J0	P1	P0	11001101b	R/W
DAC	08h	X <sub>1</sub>	X <sub>1</sub>	X <sub>1</sub>	X <sub>1</sub>	D3	D2	D1	D0	XXXX0000b	R/W
ADDR	0Dh	X <sub>1</sub>	X <sub>1</sub>	X <sub>1</sub>	X <sub>1</sub>	WC	A2	A1	A0	XXXX0000b	R/W
WRITE EE Command	3Fh	No Data									W

X = Don't care

X<sub>1</sub> = Don't care, reads as 1

DS1094L's control registers and illustrates bit locations as well as other valuable information. The memory address of each register is shown in the ADDRESS column. The factory default values programmed into EEPROM are shown in the DEFAULT column. Refer to the corresponding sections to determine what values to write to the registers.

## PRESCALER (02h)

D1, D0 Selects the dither frequency. Refer to Table 5.

Ph1, Ph0 Determines whether the two-phase, three-phase, or four-phase mode is selected. Refer to Table 3.

J1, J0 Selects the dither amount. Refer to Table 4.

P1, P0 Determines the prescaler value. Refer to Table 2.

## DAC (08h)

D3 to D0 This four-bit value determines the master oscillator frequency,  $f_{MOSC}$ . Refer to Table 1 and the *Master Oscillator* section for a detailed information on calculating the DAC value.

## ADDR (0Dh)

WC The EEPROM write control bit determines if writes to control registers are automatically backed up in NV memory (EEPROM) or whether a write EE command is required to write to NV memory. See the *EEPROM Write Control* section for more information.

A2 to A0 This three-bit value determines the 2-wire slave address.

## WRITE EE COMMAND (3Fh)

This command can be used when the WC bit = 1 (see explanation in the *EEPROM Write Control* section) to transfer registers internally from SRAM to EEPROM. The time required to store the values is one EEPROM write cycle time. This command is not needed if WC = 0.

# Multiphase Spread-Spectrum EconOscillator

DS1094L

## 2-Wire Serial Interface Description

### Definitions

The following terminology is commonly used to describe 2-wire data transfers.

**Master Device:** The master device controls the slave devices on the bus. The master device generates SCL clock pulses, start, and stop conditions.

**Slave Devices:** Slave devices send and receive data at the master's request.

**Bus Idle or Not Busy:** Time between stop and start conditions when both SDA and SCL are inactive and in their logic high states. When the bus is idle it often initiates a low-power mode for slave devices.

**Start Condition:** A start condition is generated by the master to initiate a new data transfer with a slave. Transitioning SDA from high to low while SCL remains high generates a start condition. See the timing diagram for applicable timing.

**Stop Condition:** A stop condition is generated by the master to end a data transfer with a slave. Transitioning SDA from low to high while SCL remains high generates a stop condition. See the timing diagram for applicable timing.

**Repeated Start Condition:** The master can use a repeated start condition at the end of one data transfer to indicate that it will immediately initiate a new data transfer following the current one. Repeated starts are commonly used during read operations to identify a specific memory address to begin a data transfer. A repeated start condition is issued identically to a normal start condition. See the timing diagram for applicable timing.

**Bit Write:** Transitions of SDA must occur during the low state of SCL. The data on SDA must remain valid and unchanged during the entire high pulse of SCL plus the setup and hold time requirements (see Figure 3). Data is shifted into the device during the rising edge of the SCL.

**Bit Read:** At the end of a write operation, the master must release the SDA bus line for the proper amount of setup time (see Figure 3) before the next rising edge of SCL during a bit read. The device shifts out each bit of data on SDA at the falling edge of the previous SCL pulse, and the data bit is valid at the rising edge of the current SCL pulse. Remember that the master generates all SCL clock pulses including when it is reading bits from the slave.

**Acknowledgement (ACK and NACK):** An Acknowledgement (ACK) or Not Acknowledge (NACK) is always the 9th bit transmitted during a byte transfer. The device receiving data (the master during a read or the slave during a write operation) performs an ACK by transmitting a zero during the 9th bit. A device performs a NACK by transmitting a one during the 9th bit. Timing (Figure 3) for the ACK and NACK is identical to all other bit writes. An ACK is the acknowledgement that the device is properly receiving data. A NACK is used to terminate a read sequence or as an indication that the device is not receiving data.

**Byte Write:** A byte write consists of 8 bits of information transferred from the master to the slave (most significant bit first) plus a 1-bit acknowledgement from the slave to the master. The 8 bits transmitted by the master are done according to the bit write definition, and the acknowledgement is read using the bit read definition.

**Byte Read:** A byte read is an 8-bit information transfer from the slave to the master plus a 1-bit ACK or NACK from the master to the slave. The 8 bits of information

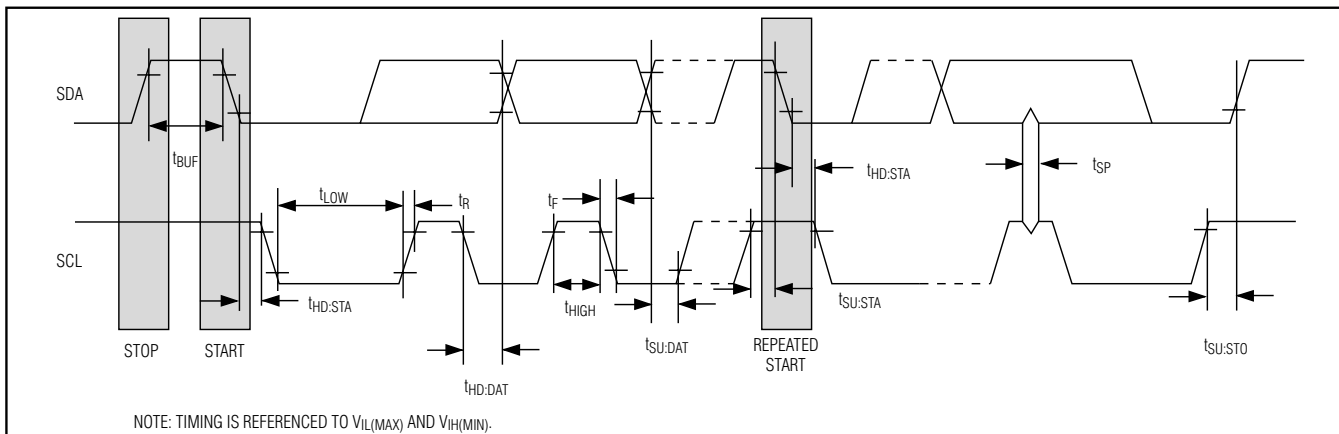

Figure 3. 2-Wire Timing Diagram

# Multiphase Spread-Spectrum EconOscillator

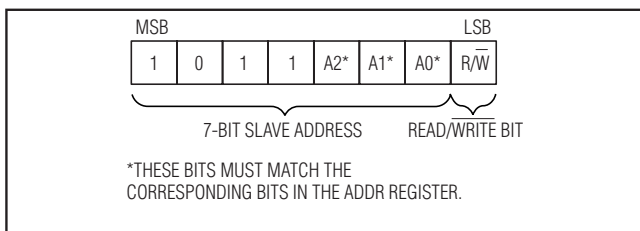

Figure 4. Slave Address Byte

that are transferred (most significant bit first) from the slave to the master are read by the master using the bit read definition above, and the master transmits an ACK using the bit write definition to receive additional data bytes. The master must NACK the last byte read to terminate communication so the slave will return control of SDA to the master.

**Slave Address Byte:** The slave address byte consists of a 7-bit slave address followed by the R/W bit (see Figure 4). The slave address is the most significant 7 bits and the R/W bit is the least significant bit. The 3 address bits in the slave address (A2 to A0) permit a maximum of eight DS1094Ls to share the same 2-wire bus.

Each slave on the 2-wire bus has a unique slave address, which is used by the master to select which slave it wishes to communicate with. Following a start condition, all slaves on the 2-wire bus await the slave address byte from the master. Each slave compares its own slave address with the slave address sent from the master. If the slave address matches, the slave acknowledges and continues communication with the master (based on the R/W bit). Otherwise, if the slave address does not match, the slave ignores communication until the next start condition.

When the R/W bit is zero, the master writes data to the specified slave. When the R/W is one, the master reads data from the specified slave.

**Memory Address:** During a 2-wire write operation, the master must transmit a memory address to identify the memory location where the slave is to store the data. The memory address is always the second byte transmitted during a write operation following the slave address byte (R/W = 0).

## 2-Wire Communication

**Writing a Single Byte to a Slave:** The master must generate a start condition, write the slave address byte (with R/W = 0), write the memory address, write the byte of data, and generate a stop condition. The master must read the slave's acknowledgement following each byte write.

**Acknowledge Polling:** Any time EEPROM is written, the EEPROM write time ( $t_{w}$ ) is required following the stop condition to write to EEPROM. During the EEPROM write time, the DS1094L will not acknowledge its slave address because it is busy. It is possible to take advantage of this phenomenon by repeatedly addressing the DS1094L until it finally acknowledges its slave address. The alternative to acknowledge polling is to wait for maximum period of  $t_{w}$  to elapse before attempting to write to EEPROM again.

**Reading a Single Byte from a Slave:** A dummy write cycle is used to read a particular register. To do this the master generates a start condition, writes the slave address byte (with R/W = 0), writes the memory address of the desired register to read, generates a repeated start condition, writes the slave address byte (with R/W = 1), reads the register and follows with a NACK (since only one byte is read), and generates a stop condition. See Figure 5 for examples of reading DS1094L registers.

## Application Information

### SDA and SCL Pullup Resistors

SDA is an open-collector output and requires a pullup resistor to realize high logic levels. Because the DS1094L does not utilize clock cycle stretching, a master using either an open-collector output with a pullup resistor or CMOS output driver (push-pull) can be utilized for SCL. Pullup resistor values should be chosen to ensure that the rise and fall times listed in the AC electrical characteristics are within specification.

### Stand-Alone Operation

If the DS1094L is used stand-alone (without a 2-wire master), SDA and SCL should not be left unconnected, or floating. It is recommended that pullup resistors be used on both SDA and SCL to prevent the pins from floating to unknown voltages and transitions. Likewise, pullups are recommended over tying SDA and SCL directly to VCC to allow future programmability.

### Power-Supply Decoupling

To achieve best results, it is highly recommended that a decoupling capacitor is used on the IC power supply pins. Typical values of decoupling capacitors are 0.01 $\mu$ F and 0.1 $\mu$ F. Use high-quality, ceramic, surface-mount capacitors. Mount the capacitors as close as possible to the VCC and GND pins of the IC to minimize lead inductance.

# Multiphase Spread-Spectrum EconOscillator

DS1094L

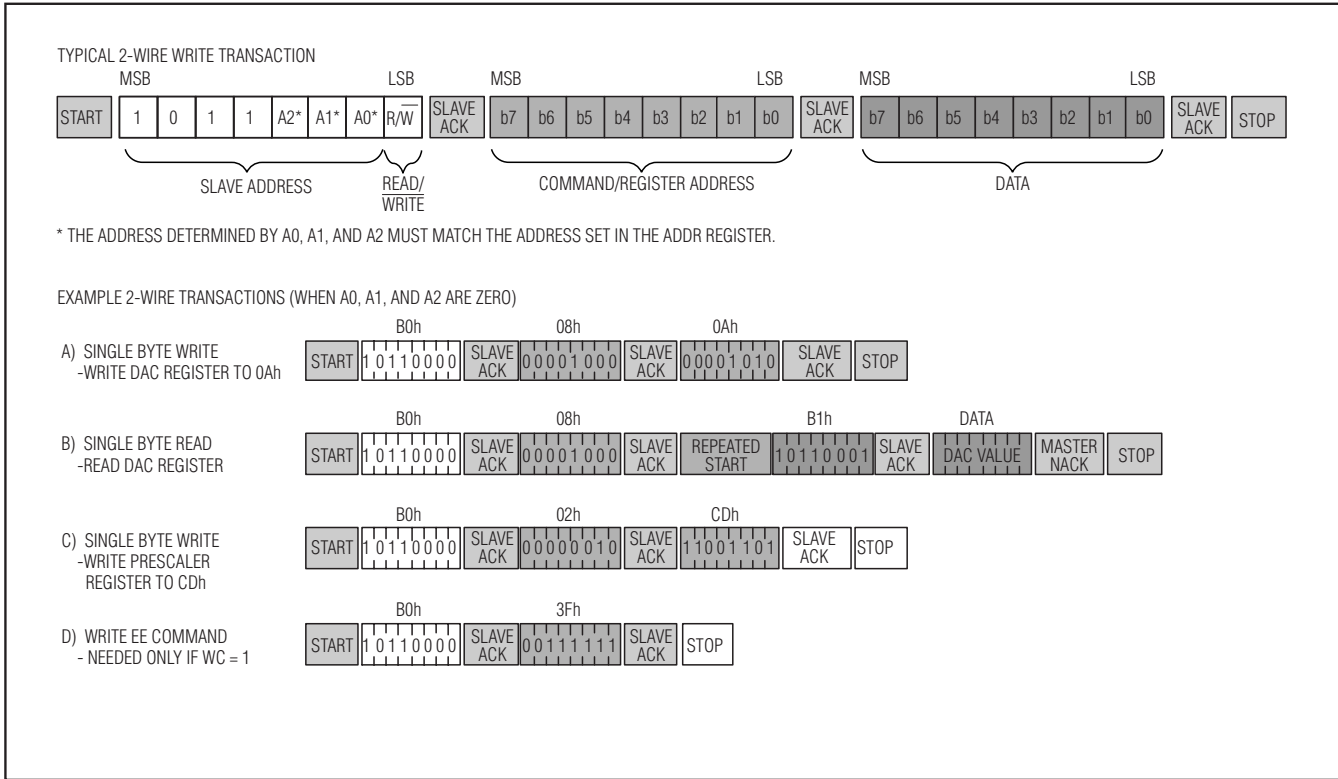

Figure 5. 2-Wire Communication Examples

## Chip Topology

TRANSISTOR COUNT: 7987  
SUBSTRATE CONNECTED TO: GROUND

## Package Information

For the latest package outline information, go to [www.maxim-ic.com/DallasPackInfo](http://www.maxim-ic.com/DallasPackInfo).

Maxim cannot assume responsibility for use of any circuitry other than circuitry entirely embodied in a Maxim product. No circuit patent licenses are implied. Maxim reserves the right to change the circuitry and specifications without notice at any time.

Maxim Integrated Products, 120 San Gabriel Drive, Sunnyvale, CA 94086 408-737-7600 \_\_\_\_\_ 11

© 2004 Maxim Integrated Products Printed USA **MAXIM** is a registered trademark of Maxim Integrated Products.

**DALLAS** SEMICONDUCTOR DALLAS is a registered trademark of Dallas Semiconductor Corporation.