



Chipsmall Limited consists of a professional team with an average of over 10 year of expertise in the distribution of electronic components. Based in Hongkong, we have already established firm and mutual-benefit business relationships with customers from,Europe,America and south Asia,supplying obsolete and hard-to-find components to meet their specific needs.

With the principle of “Quality Parts,Customers Priority,Honest Operation,and Considerate Service”,our business mainly focus on the distribution of electronic components. Line cards we deal with include Microchip,ALPS,ROHM,Xilinx,Pulse,ON,Everlight and Freescale. Main products comprise IC,Modules,Potentiometer,IC Socket,Relay,Connector.Our parts cover such applications as commercial,industrial, and automotives areas.

We are looking forward to setting up business relationship with you and hope to provide you with the best service and solution. Let us make a better world for our industry!



## Contact us

Tel: +86-755-8981 8866 Fax: +86-755-8427 6832

Email & Skype: info@chipsmall.com Web: www.chipsmall.com

Address: A1208, Overseas Decoration Building, #122 Zhenhua RD., Futian, Shenzhen, China



## Temperature Logger *i*Button with 8KB Data-Log Memory

### General Description

The DS1922L/DS1922T temperature logger *i*Buttons® are rugged, self-sufficient systems that measure temperature and record the result in a protected memory section. The recording is done at a user-defined rate. A total of 8192 8-bit readings or 4096 16-bit readings, taken at equidistant intervals ranging from 1s to 273hr, can be stored. Additionally, 512 bytes of SRAM store application-specific information and 64 bytes store calibration data. A mission to collect data can be programmed to begin immediately, after a user-defined delay, or after a temperature alarm. Access to the memory and control functions can be password protected. The DS1922L/DS1922T are configured and communicate with a host-computing device through the serial 1-Wire® protocol, which requires only a single data lead and a ground return. Each DS1922L/DS1922T is factory lasered with a guaranteed unique 64-bit registration number that allows for absolute traceability. The durable stainless-steel package is highly resistant to environmental hazards such as dirt, moisture, and shock. Accessories permit the DS1922L/DS1922T to be mounted on almost any object, including containers, pallets, and bags.

### Applications

High-Temperature Logging (Process Monitoring, Industrial Temperature Monitoring)

Temperature Logging in Cold Chain, Food Safety, Bio Science, and Pharmaceutical and Medical Products

### Features

- ◆ **Automatically Wakes Up, Measures Temperature, and Stores Values in 8KB of Data-Log Memory in 8-Bit or 16-Bit Format**
- ◆ **Digital Thermometer Measures Temperature with 8-Bit (0.5°C) or 11-Bit (0.0625°C) Resolution**
- ◆ **Accuracy of ±0.5°C from -10°C to +65°C (DS1922L), ± 0.5°C from +20°C to +75°C (DS1922T), with Software Corrections**
- ◆ **Water Resistant or Waterproof if Placed Inside DS9107 *i*Button Capsule (Exceeds Water Resistant 3 ATM Requirements)**
- ◆ **Sampling Rate from 1s Up to 273hr**
- ◆ **Programmable High and Low Trip Points for Temperature Alarms**
- ◆ **Programmable Recording Start Delay After Elapsed Time or Upon a Temperature Alarm Trip Point**
- ◆ **Quick Access to Alarmed Devices Through 1-Wire Conditional Search Function**
- ◆ **512 Bytes of General-Purpose Memory Plus 64 Bytes of Calibration Memory**

*i*Button and 1-Wire are registered trademarks of Maxim Integrated Products, Inc.

- ◆ **Two-Level Password Protection of All Memory and Configuration Registers**
- ◆ **Communicates to Host with a Single Digital Signal Up to 15.4kbps at Standard Speed or Up to 125kbps in Overdrive Mode Using 1-Wire Protocol**
- ◆ **Operating Temperature Range: DS1922L: -40°C to +85°C; DS1922T: 0°C to +125°C**

### Common *i*Button Features

- ◆ **Digital Identification and Information by Momentary Contact**
- ◆ **Unique Factory-Lasered 64-Bit Registration Number Ensures Error-Free Device Selection and Absolute Traceability Because No Two Parts Are Alike**
- ◆ **Built-In Multidrop Controller for 1-Wire Net**
- ◆ **Chip-Based Data Carrier Compactly Stores Information**
- ◆ **Data Can Be Accessed While Affixed to Object**
- ◆ **Button Shape is Self-Aligning with Cup-Shaped Probes**
- ◆ **Durable Stainless-Steel Case Engraved with Registration Number Withstands Harsh Environments**
- ◆ **Easily Affixed with Self-Stick Adhesive Backing, Latched by Its Flange, or Locked with a Ring Pressed Onto Its Rim**
- ◆ **Presence Detector Acknowledges When Reader First Applies Voltage**
- ◆ **Meets UL 913, 5th Ed., Rev. 1997-02-24; Intrinsically Safe Apparatus: Approved Under Entity Concept for Use in Class I, Division 1, Group A, B, C, and D Locations**

### Ordering Information

PART	TEMP RANGE	PIN-PACKAGE
DS1922L-F5#	-40°C to +85°C	F5 <i>i</i> Button
DS1922T-F5#	0°C to +125°C	F5 <i>i</i> Button

#Denotes a RoHS-compliant device that may include lead(Pb) that is exempt under the RoHS requirements.

### Examples of Accessories

PART	ACCESSORY
DS9096P	Self-Stick Adhesive Pad
DS9101	Multipurpose Clip
DS9093RA	Mounting Lock Ring
DS9093A	Snap-in FOB
DS9092	<i>i</i> Button Probe

Pin Configuration appears at end of data sheet.

**For pricing, delivery, and ordering information, please contact Maxim Direct at 1-888-629-4642, or visit Maxim's website at [www.maximintegrated.com](http://www.maximintegrated.com).**

# DS1922L/DS1922T

## Temperature Logger *i*Button with 8KB Data-Log Memory

### ABSOLUTE MAXIMUM RATINGS

IO Voltage Range to GND .....	-0.3V to +6V	Junction Temperature .....	+150°C
IO Sink Current .....	20mA	Storage Temperature Range*	
Operating Temperature Range		DS1922L .....	-40°C to +85°C*
DS1922L .....	-40°C to +85°C	DS1922T .....	0°C to +125°C*
DS1922T .....	0°C to +125°C		

\*Storage or operation above +50°C significantly reduces battery life.

Stresses beyond those listed under "Absolute Maximum Ratings" may cause permanent damage to the device. These are stress ratings only, and functional operation of the device at these or any other conditions beyond those indicated in the operational sections of the specifications is not implied. Exposure to absolute maximum rating conditions for extended periods may affect device reliability.

### ELECTRICAL CHARACTERISTICS

(V<sub>PUP</sub> = +3.0V to +5.25V.)

PARAMETER	SYMBOL	CONDITIONS	MIN	TYP	MAX	UNITS
Operating Temperature	T <sub>A</sub>	DS1922L (Note 1)	-40		+85	°C
		DS1922T (Note 1)	0		+125	
<b>IO PIN: GENERAL DATA</b>						
1-Wire Pullup Resistance	R <sub>PUP</sub>	(Notes 2, 3)			2.2	kΩ
Input Capacitance	C <sub>IO</sub>	(Note 4)		100	800	pF
Input Load Current	I <sub>L</sub>	IO pin at V <sub>PUP</sub>		6	10	μA
High-to-Low Switching Threshold	V <sub>TL</sub>	(Notes 5, 6)	0.4		3.2	V
Input Low Voltage	V <sub>IL</sub>	(Notes 2, 7)			0.3	V
Low-to-High Switching Threshold	V <sub>TH</sub>	(Notes 5, 8)	0.7		3.4	V
Switching Hysteresis	V <sub>HY</sub>	(Note 9)	0.09		N/A	V
Output Low Voltage	V <sub>OL</sub>	At 4mA (Note 10)			0.4	V
Recovery Time (Note 2)	t <sub>REC</sub>	Standard speed, R <sub>PUP</sub> = 2.2kΩ	5			μs
		Overdrive speed, R <sub>PUP</sub> = 2.2kΩ	2			
		Overdrive speed, directly prior to reset pulse; R <sub>PUP</sub> = 2.2kΩ	5			
Rising-Edge Hold-Off Time	t <sub>REH</sub>	(Note 11)	0.6		2.0	μs
Time-Slot Duration (Note 2)	t <sub>SLOT</sub>	Standard speed	65			μs
		Overdrive speed, V <sub>PUP</sub> > 4.5V	8			
		Overdrive speed (Note 12)	<b>9.5</b>			
<b>IO PIN: 1-Wire RESET, PRESENCE-DETECT CYCLE</b>						
Reset Low Time (Note 2)	t <sub>RSTL</sub>	Standard speed, V <sub>PUP</sub> > 4.5V	480		720	μs
		Standard speed (Note 12)	<b>690</b>		720	
		Overdrive speed, V <sub>PUP</sub> > 4.5V	48		80	
		Overdrive speed (Note 12)	<b>70</b>		80	
Presence-Detect High Time	t <sub>PDH</sub>	Standard speed, V <sub>PUP</sub> > 4.5V	15		60	μs
		Standard speed (Note 12)	15		<b>63.5</b>	
		Overdrive speed (Note 12)	2		<b>7</b>	
Presence-Detect Fall Time (Note 13)	t <sub>FPD</sub>	Standard speed, V <sub>PUP</sub> > 4.5V	1.5		5	μs
		Standard speed	1.5		8	
		Overdrive speed	0.15		1	

# DS1922L/DS1922T

## Temperature Logger *i*Button with 8KB Data-Log Memory

### ELECTRICAL CHARACTERISTICS (continued)

( $V_{PUP} = +3.0V$  to  $+5.25V$ .)

PARAMETER	SYMBOL	CONDITIONS	MIN	TYP	MAX	UNITS
Presence-Detect Low Time	$t_{PDL}$	Standard speed, $V_{PUP} > 4.5V$	60		240	$\mu s$
		Standard speed (Note 12)	60		<b>287</b>	
		Overdrive speed, $V_{PUP} > 4.5V$ (Note 12)	<b>7</b>		24	
		Overdrive speed (Note 12)	<b>7</b>		<b>28</b>	
Presence-Detect Sample Time (Note 2)	$t_{MSP}$	Standard speed, $V_{PUP} > 4.5V$	65		75	$\mu s$
		Standard speed	71.5		75	
		Overdrive speed	8		9	
<b>IO PIN: 1-Wire WRITE</b>						
Write-Zero Low Time (Notes 2, 14)	$t_{W0L}$	Standard speed	60		120	$\mu s$
		Overdrive Speed, $V_{PUP} > 4.5V$ (Note 12)	6		<b>12</b>	
		Overdrive speed (Note 12)	<b>7.5</b>		<b>12</b>	
Write-One Low Time (Notes 2, 14)	$t_{W1L}$	Standard speed	5		15	$\mu s$
		Overdrive speed	1		1.95	
<b>IO PIN: 1-Wire READ</b>						
Read Low Time (Notes 2, 15)	$t_{RL}$	Standard speed	5		$15 - \delta$	$\mu s$
		Overdrive speed	1		$1.95 - \delta$	
Read Sample Time (Notes 2, 15)	$t_{MSR}$	Standard speed	$t_{RL} + \delta$		15	$\mu s$
		Overdrive speed	$t_{RL} + \delta$		1.95	
<b>REAL-TIME CLOCK</b>						
Accuracy			See RTC Accuracy graphs			min/month
Frequency Deviation	$\Delta F$	-40°C to +85°C	-300		+60	PPM
		0°C to +125°C	-600		+60	
<b>TEMPERATURE CONVERTER</b>						
Conversion Time (Note 16)	$t_{CONV}$	8-bit mode	30		75	ms
		16-bit mode (11 bits)	240		600	
Thermal Response Time Constant (Note 17)	$\tau_{RESP}$	<i>i</i> Button package	130			s
Conversion Error Without Software Correction	$\Delta\theta$	(Notes 18, 19)	See Temperature Accuracy graphs			°C
Conversion Error with Software Correction	$\Delta\theta$	(Notes 19, 20)	See Temperature Accuracy graphs			°C

**Note 1:** Guaranteed by design, not production tested to -40°C or +125°C.

**Note 2:** System requirement.

**Note 3:** Maximum allowable pullup resistance is a function of the number of 1-Wire devices in the system and 1-Wire recovery times. The specified value here applies to systems with only one device and with the minimum 1-Wire recovery times. For more heavily loaded systems, an active pullup such as that found in the DS2480B may be required.

**Note 4:** Capacitance on the data pin could be 800pF when  $V_{PUP}$  is first applied. If a 2.2k $\Omega$  resistor is used to pull up the data line, 2.5 $\mu s$  after  $V_{PUP}$  has been applied, the parasite capacitance does not affect normal communications.

**Note 5:**  $V_{TL}$  and  $V_{TH}$  are functions of the internal supply voltage, which is a function of  $V_{PUP}$  and the 1-Wire recovery times. The  $V_{TH}$  and  $V_{TL}$  maximum specifications are valid at  $V_{PUP} = 5.25V$ . In any case,  $V_{TL} < V_{TH} < V_{PUP}$ .

**Note 6:** Voltage below which, during a falling edge on IO, a logic 0 is detected.

# DS1922L/DS1922T

## Temperature Logger *i*Button with 8KB Data-Log Memory

### ELECTRICAL CHARACTERISTICS (continued)

( $V_{PUP} = +3.0V$  to  $+5.25V$ .)

- Note 7:** The voltage on IO must be less than or equal to  $V_{ILMAX}$  whenever the master drives the line low.
- Note 8:** Voltage above which, during a rising edge on IO, a logic 1 is detected.
- Note 9:** After  $V_{TH}$  is crossed during a rising edge on IO, the voltage on IO must drop by  $V_{HY}$  to be detected as logic 0.
- Note 10:** The I-V characteristic is linear for voltages less than 1V.
- Note 11:** The earliest recognition of a negative edge is possible at  $t_{REH}$  after  $V_{TH}$  has been previously reached.
- Note 12:** Numbers in **bold** are **not** in compliance with the published *i*Button standards. See the *Comparison Table*.
- Note 13:** Interval during the negative edge on IO at the beginning of a presence-detect pulse between the time at which the voltage is 90% of  $V_{PUP}$  and the time at which the voltage is 10% of  $V_{PUP}$ .
- Note 14:**  $\epsilon$  in Figure 13 represents the time required for the pullup circuitry to pull the voltage on IO up from  $V_{IL}$  to  $V_{TH}$ . The actual maximum duration for the master to pull the line low is  $t_{W1LMAX} + t_F - \epsilon$  and  $t_{W0LMAX} + t_F - \epsilon$ , respectively.
- Note 15:**  $\delta$  in Figure 13 represents the time required for the pullup circuitry to pull the voltage on IO up from  $V_{IL}$  to the input-high threshold of the bus master. The actual maximum duration for the master to pull the line low is  $t_{RLMAX} + t_F$ .
- Note 16:** To conserve battery power, use 8-bit temperature logging whenever possible.
- Note 17:** This number was derived from a test conducted by Cemagref in Antony, France, in July 2000: [www.cemagref.fr/English/index.htm](http://www.cemagref.fr/English/index.htm) Test Report No. E42.
- Note 18:** Includes  $+0.1/-0.2^{\circ}C$  calibration chamber measurement uncertainty.
- Note 19: Warning:** Not for use as the sole method of measuring or tracking temperature in products and articles that could affect the health or safety of persons, plants, animals, or other living organisms, including but not limited to foods, beverages, pharmaceuticals, medications, blood and blood products, organs, flammable, and combustible products. User shall assure that redundant (or other primary) methods of testing and determining the handling methods, quality, and fitness of the articles and products should be implemented. Temperature tracking with this product, where the health or safety of the aforementioned persons or things could be adversely affected, is only recommended when supplemental or redundant information sources are used. Data-logger products are 100% tested and calibrated at time of manufacture by Maxim to ensure that they meet all data sheet parameters, including temperature accuracy. User shall be responsible for proper use and storage of this product. As with any sensor-based product, user shall also be responsible for occasionally rechecking the temperature accuracy of the product to ensure it is still operating properly.
- Note 20:** Assumes using calibration memory with calibration equations for error compensation. Includes  $+0.1/-0.2^{\circ}C$  calibration chamber measurement uncertainty. Guaranteed by design.

### COMPARISON TABLE

PARAMETER	LEGACY VALUES				DS1922L/DS1922T VALUES			
	STANDARD SPEED ( $\mu s$ )		OVERDRIVE SPEED ( $\mu s$ )		STANDARD SPEED ( $\mu s$ )		OVERDRIVE SPEED ( $\mu s$ )	
	MIN	MAX	MIN	MAX	MIN	MAX	MIN	MAX
$t_{SLOT}$ (including $t_{REC}$ )	61	(undefined)	7	(undefined)	65	(undefined)	<b>9.5</b>	(undefined)
$t_{RSTL}$	480	(undefined)	48	80	<b>690</b>	720	<b>70</b>	80
$t_{PDH}$	15	60	2	6	15	<b>63.5</b>	2	<b>7</b>
$t_{PDL}$	60	240	8	24	60	<b>287</b>	<b>7</b>	<b>28</b>
$t_{WOL}$	60	120	6	16	60	120	<b>7.5</b>	<b>12</b>

\*Intentional change; longer recovery time requirement due to modified 1-Wire front-end.

**Note:** Numbers in **bold** are **not** in compliance with the published *i*Button standards.

### *i*Button CAN PHYSICAL SPECIFICATION

<b>SIZE</b>	See the <i>Package Information</i> section.
<b>WEIGHT</b>	Ca. 3.3 grams
<b>SAFETY</b>	Meets UL 913, 5th Ed., Rev. 1997-02-24; Intrinsically Safe Apparatus, approval under Entity Concept for use in Class I, Division 1, Group A, B, C, and D Locations.

# DS1922L/DS1922T

## Temperature Logger *i*Button with 8KB Data-Log Memory

### DS1922L Minimum Product Lifetime vs. Temperature, Slow Sampling

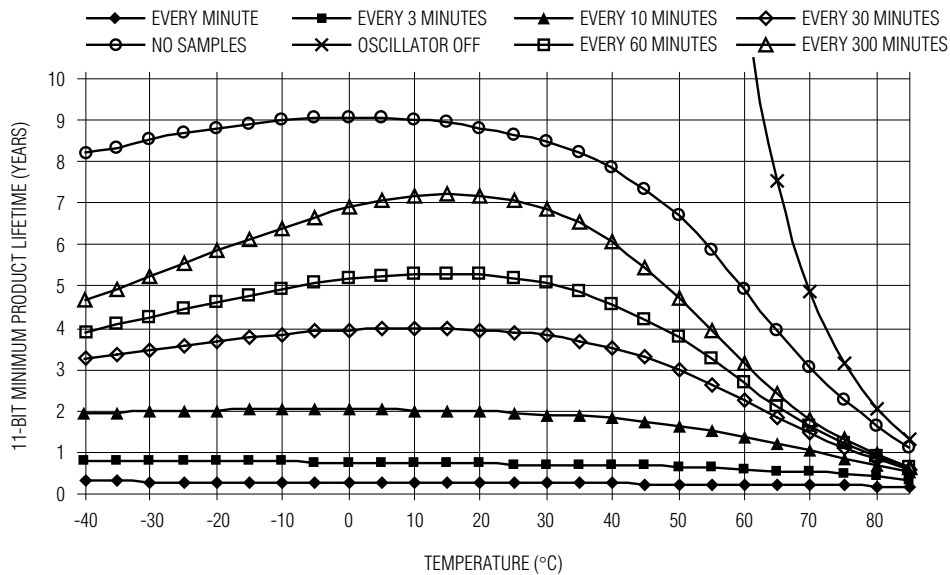
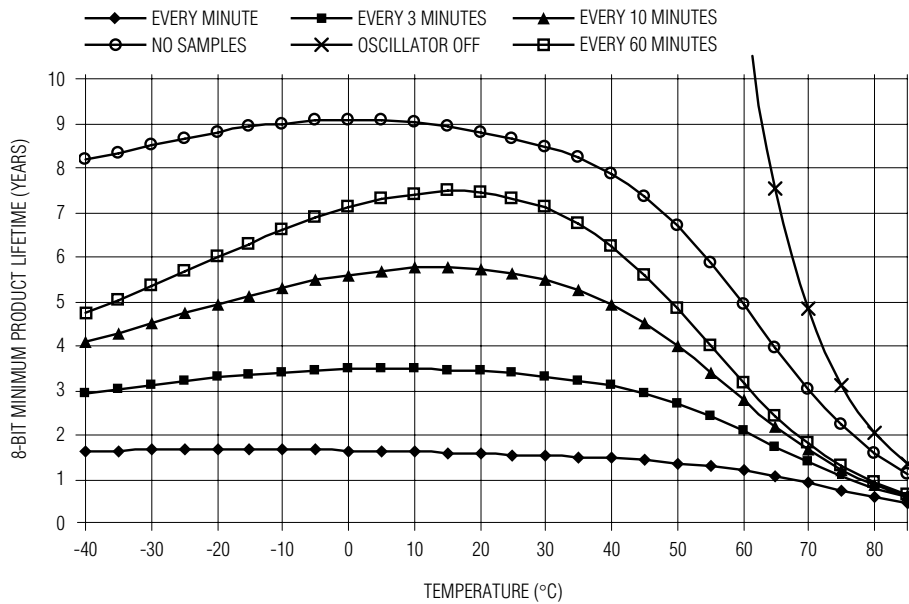

# DS1922L/DS1922T

## Temperature Logger *i*Button with 8KB Data-Log Memory

### DS1922L Minimum Product Lifetime vs. Temperature, Fast Sampling

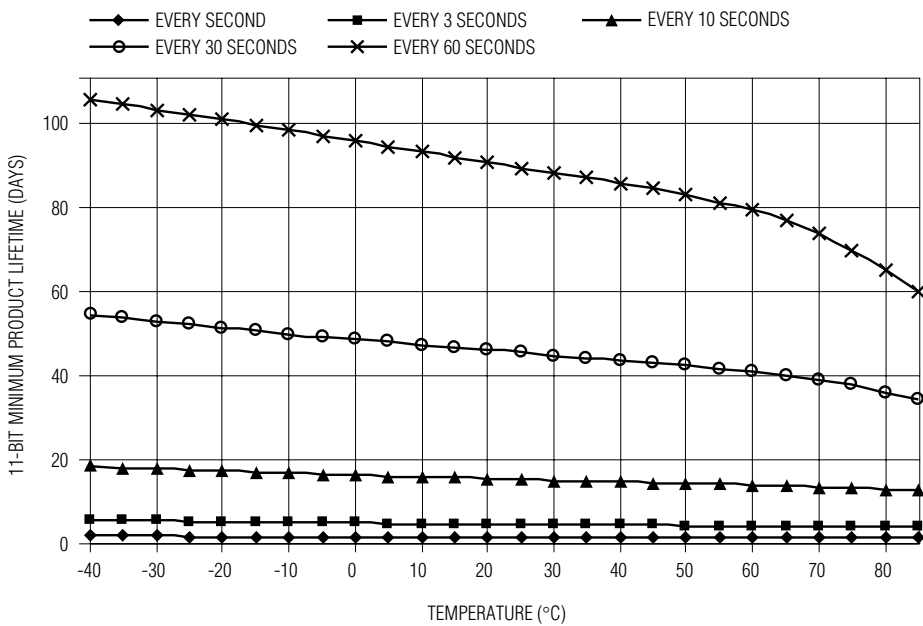
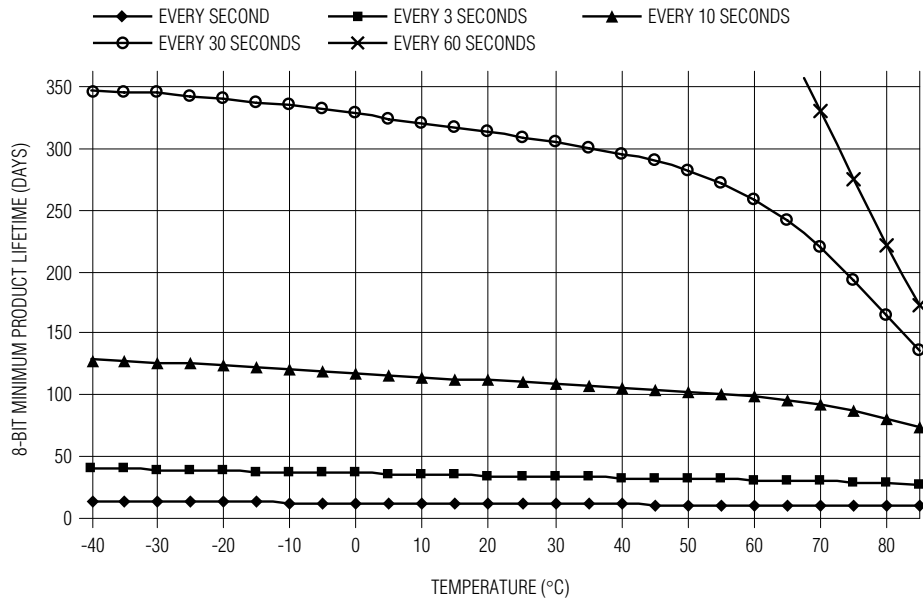

# DS1922L/DS1922T

## Temperature Logger iButton with 8KB Data-Log Memory

### DS1922T Minimum Product Lifetime vs. Temperature, Slow Sampling

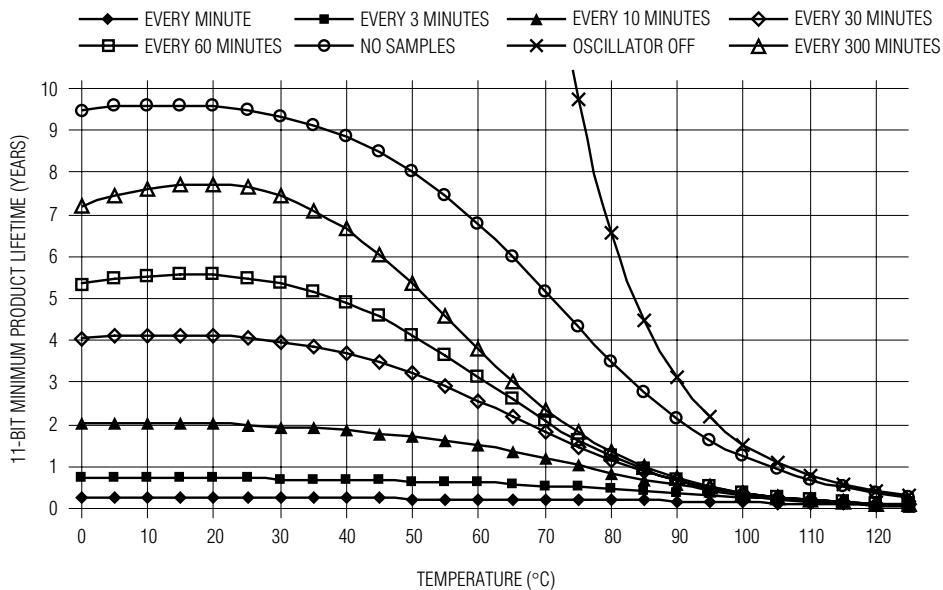
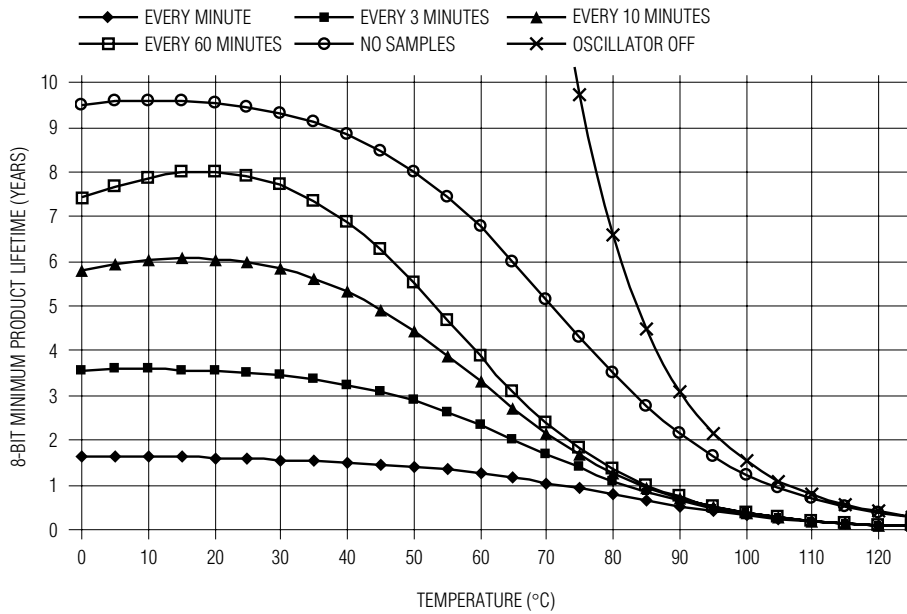



# DS1922L/DS1922T

## Temperature Logger *i*Button with 8KB Data-Log Memory

### DS1922T Minimum Product Lifetime vs. Temperature, Fast Sampling

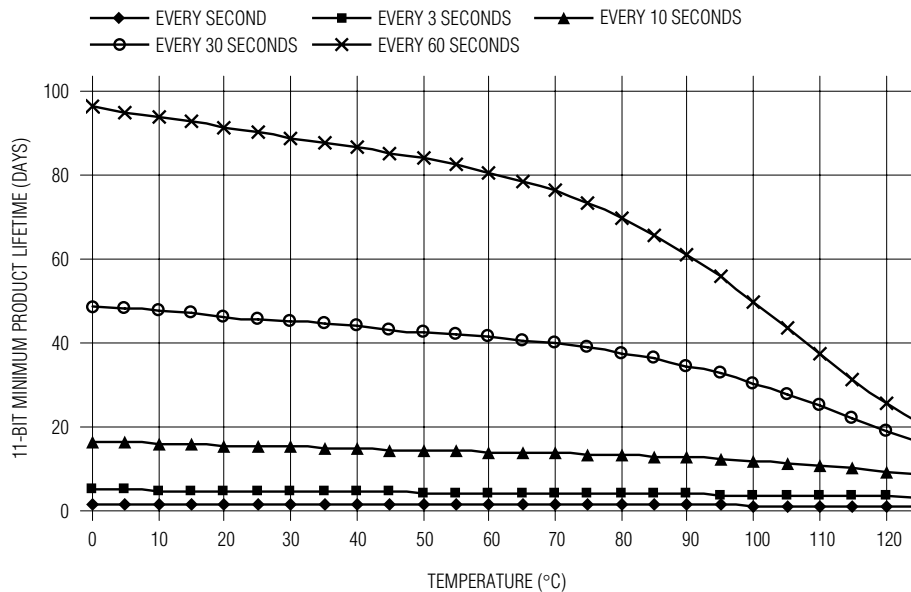
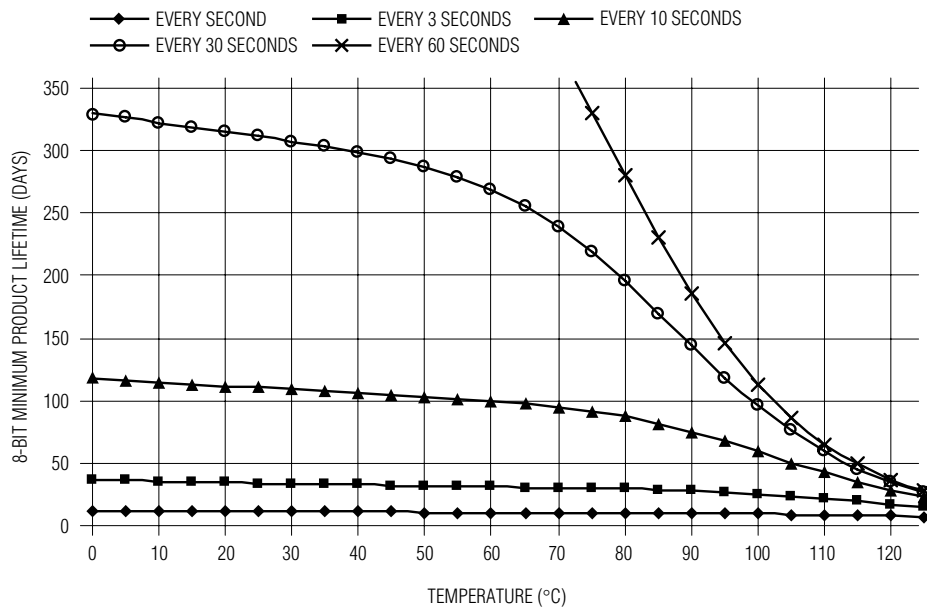

# DS1922L/DS1922T

## Temperature Logger *i*Button with 8KB Data-Log Memory

**DS1922L Minimum Product Lifetime vs. Sample Rate**

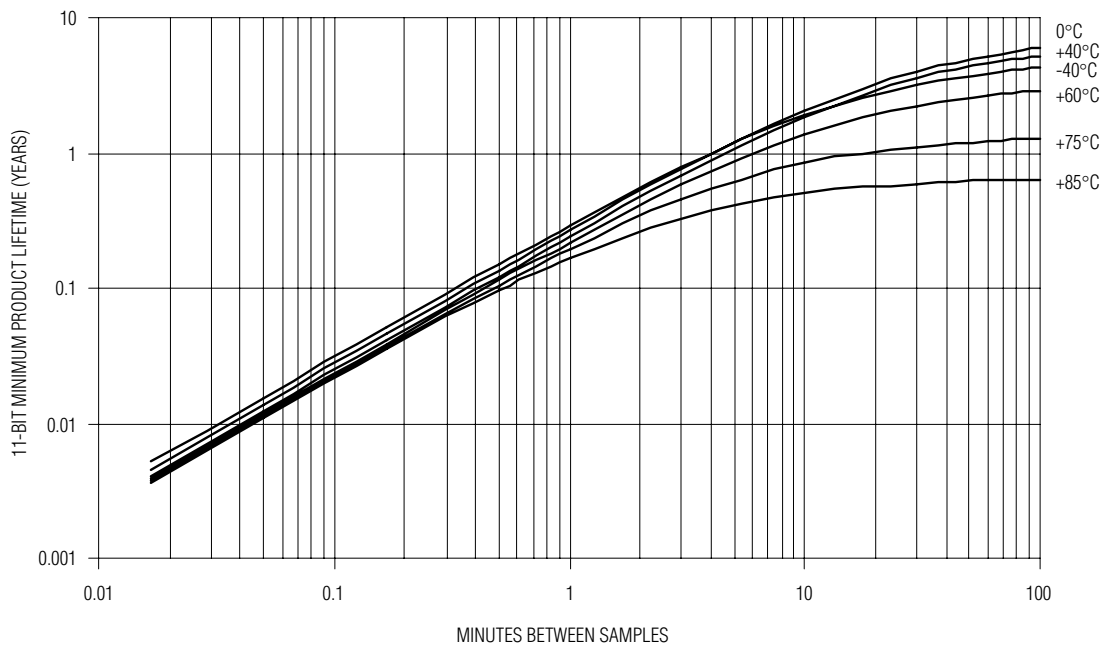
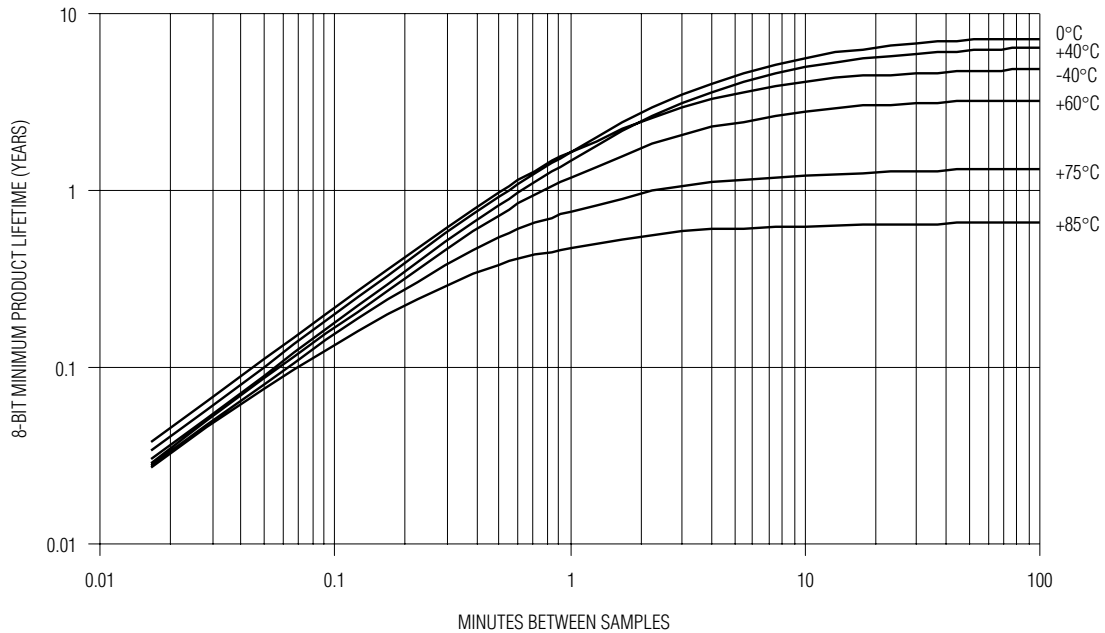

# DS1922L/DS1922T

## Temperature Logger *i*Button with 8KB Data-Log Memory

**DS1922T Minimum Product Lifetime vs. Sample Rate**

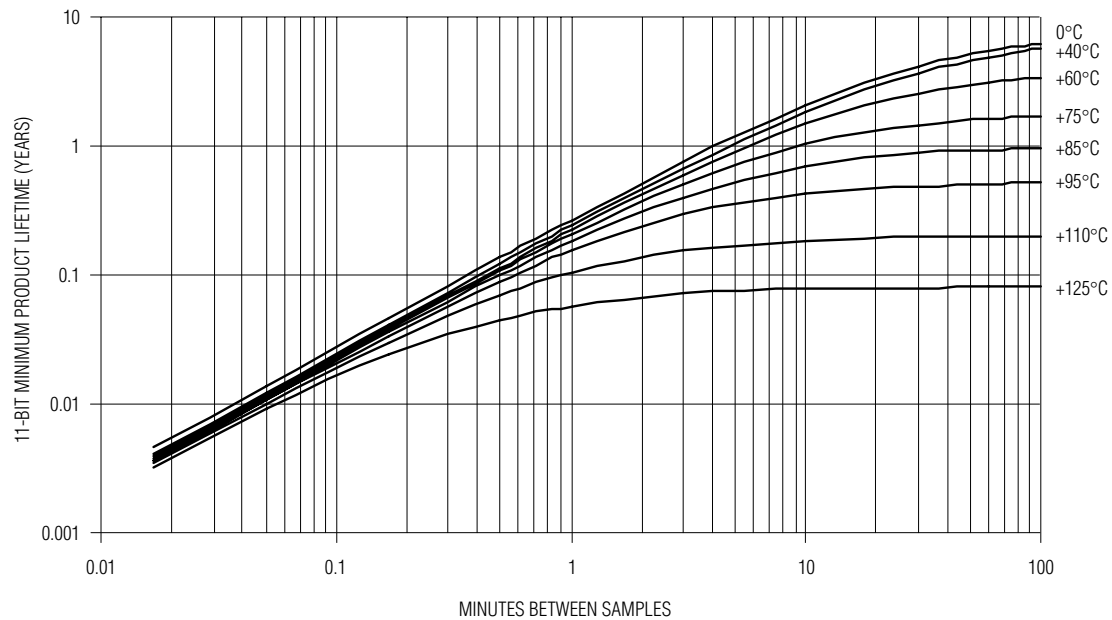
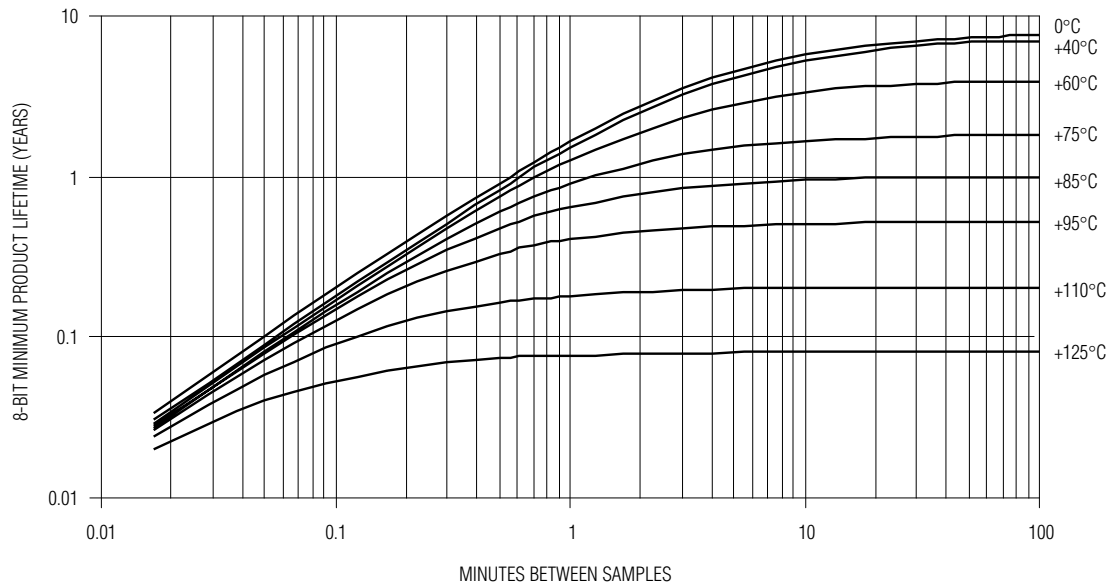

# DS1922L/DS1922T

## Temperature Logger *i*Button with 8KB Data-Log Memory

### DS1922L Temperature Accuracy

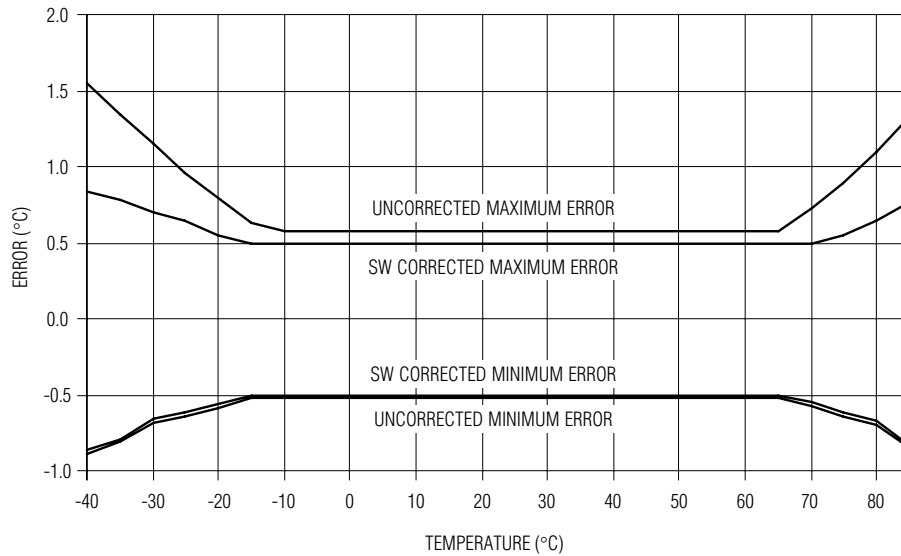

**NOTE:** THE GRAPHS ARE BASED ON 11-BIT DATA.

### DS1922T Temperature Accuracy

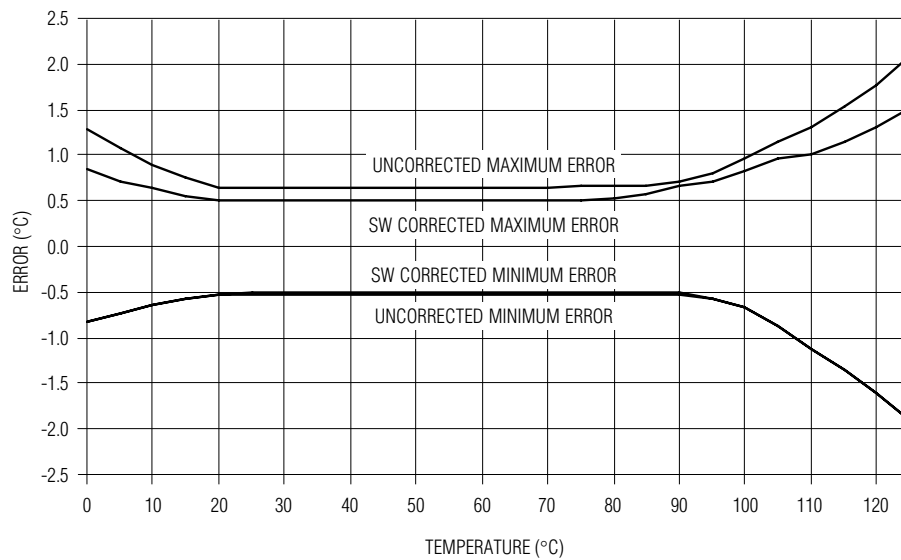

**NOTE:** THE GRAPHS ARE BASED ON 11-BIT DATA.

# DS1922L/DS1922T

## Temperature Logger *i*Button with 8KB Data-Log Memory

**DS1922L RTC Accuracy (Typical)**

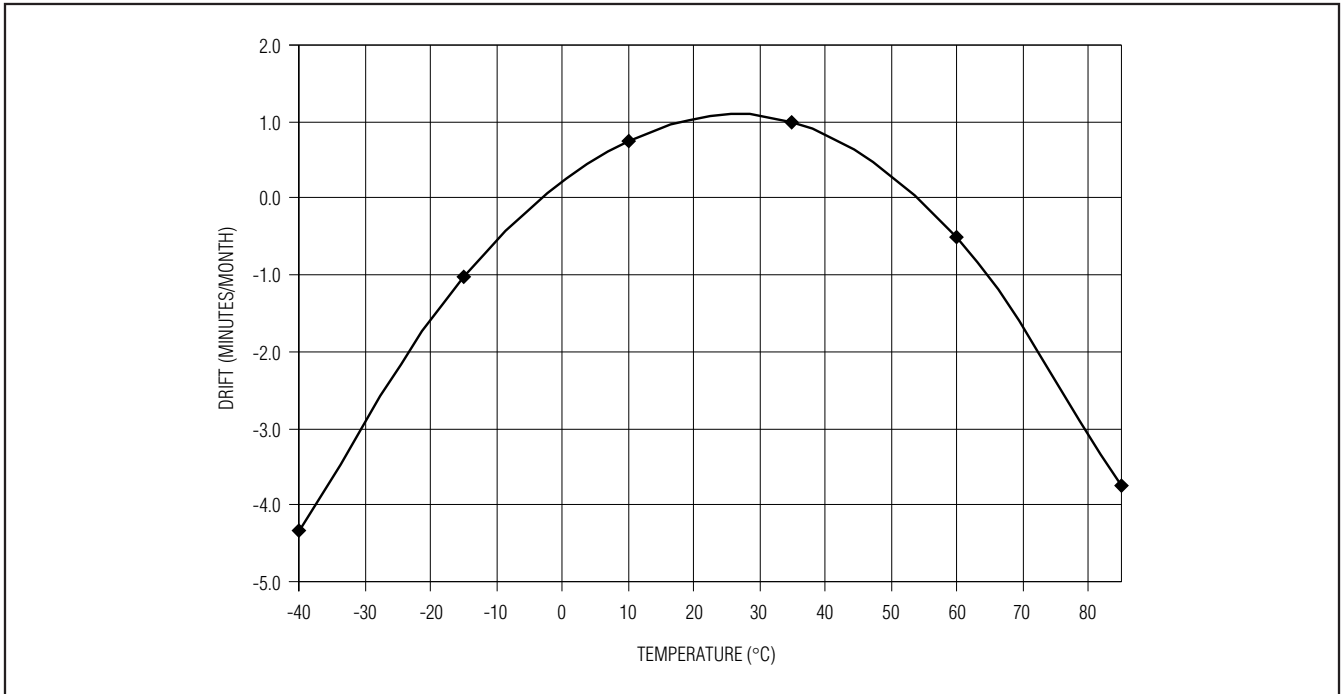

**DS1922T RTC Accuracy (Typical)**

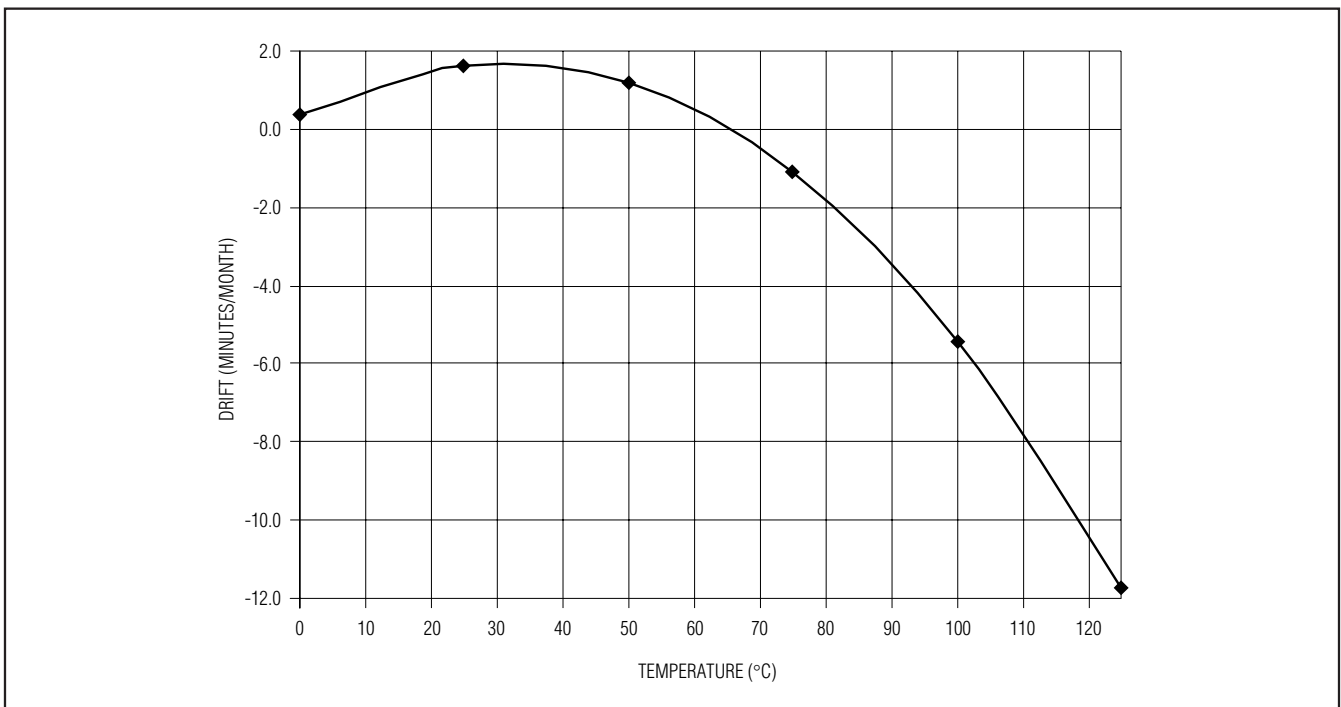

# DS1922L/DS1922T

## Temperature Logger iButton with 8KB Data-Log Memory

### Detailed Description

The DS1922L is an ideal device to monitor for extended periods of time the temperature of any object it is attached to or shipped with, such as fresh produce, medical drugs and supplies, and for use in refrigerators and freezers. With its shifted temperature range, the DS1922T is suited to monitor processes that require temperatures close to the boiling point of water, such as pasteurization of food items. Note that the initial sealing level of the DS1922L/DS1922T achieves the equivalent of IP56. Aging and use conditions can degrade the integrity of the seal over time, so for applications with significant exposure to liquids, sprays, or other similar environments, it is recommended to place the DS1922L/DS1922T in the DS9107 iButton capsule. The DS9107 provides a watertight enclosure that has been rated to IP68 (refer to Application Note 4126: *Understanding the IP (Ingress Protection) Ratings of iButton Data Loggers and Capsules*). Software for setup and data retrieval through the 1-Wire interface is available for free download from the iButton website ([www.ibutton.com](http://www.ibutton.com)). This software also includes drivers for the serial and USB port of a PC and routines to access the general-purpose memory for storing application-specific or equipment-specific data files.

All iButton data loggers are calibrated/validated against NIST traceable reference devices. Maxim offers a web application to generate validation certificates for the DS1922L, DS1922T, DS1922E, and DS1923 (temperature portion only) data loggers. Input is the iButton's ROM code (or list of codes) and the output is a validation certificate in PDF format. For more information, refer to Application Note 4629: *iButton® Data-Logger Calibration and NIST Certificate FAQs*.

### Overview

The block diagram in Figure 1 shows the relationships between the major control and memory sections of the DS1922L/DS1922T. The devices have six main data components: 64-bit lasered ROM; 256-bit scratchpad; 512-byte general-purpose SRAM; two 256-bit register pages of timekeeping, control, status, and counter registers, and passwords; 64 bytes of calibration memory; and 8192 bytes of data-logging memory. Except for the ROM and the scratchpad, all other memory is arranged in a single linear address space. The data-logging memory, counter registers, and several other registers are read only for the user. Both register pages are write protected while the device is programmed for a mission. The password registers, one for a read password and another one for a read/write password, can only be written, never read.

Figure 2 shows the hierarchical structure of the 1-Wire protocol. The bus master must first provide one of the eight ROM function commands: Read ROM, Match ROM, Search ROM, Conditional Search ROM, Skip ROM, Overdrive-Skip ROM, Overdrive-Match ROM, or Resume. Upon completion of an Overdrive ROM command executed at standard speed, the device enters overdrive mode, where all subsequent communication occurs at a higher speed. The protocol required for these ROM function commands is described in Figure 11. After a ROM function command is successfully executed, the memory and control functions become accessible and the master can provide any one of the eight available commands. The protocol for these memory and control function commands is described in Figure 9. **All data is read and written least significant bit first.**

### Parasite Power

The block diagram (Figure 1) shows the parasite-powered circuitry. This circuitry “steals” power whenever the IO input is high. IO provides sufficient power as long as the specified timing and voltage requirements are met. The advantages of parasite power are twofold: 1) By parasiting off this input, battery power is not consumed for 1-Wire ROM function commands, and 2) if the battery is exhausted for any reason, the ROM may still be read normally. The remaining circuitry of the DS1922 is solely operated by battery energy.

### 64-Bit Lasered ROM

Each DS1922L/DS1922T contains a unique ROM code that is 64 bits long. The first 8 bits are a 1-Wire family code. The next 48 bits are a unique serial number. The last 8 bits are a cyclic redundancy check (CRC) of the first 56 bits (see Figure 3 for details). The 1-Wire CRC is generated using a polynomial generator consisting of a shift register and XOR gates as shown in Figure 4. The polynomial is  $X^8 + X^5 + X^4 + 1$ . Additional information about the 1-Wire CRC is available in Application Note 27: *Understanding and Using Cyclic Redundancy Checks with Maxim iButton Products*.

The shift register bits are initialized to 0. Then, starting with the least significant bit of the family code, one bit at a time is shifted in. After the 8th bit of the family code has been entered, the serial number is entered. After the last bit of the serial number has been entered, the shift register contains the CRC value. Shifting in the 8 bits of CRC returns the shift register to all 0s.

# DS1922L/DS1922T

## Temperature Logger *i*Button with 8KB Data-Log Memory

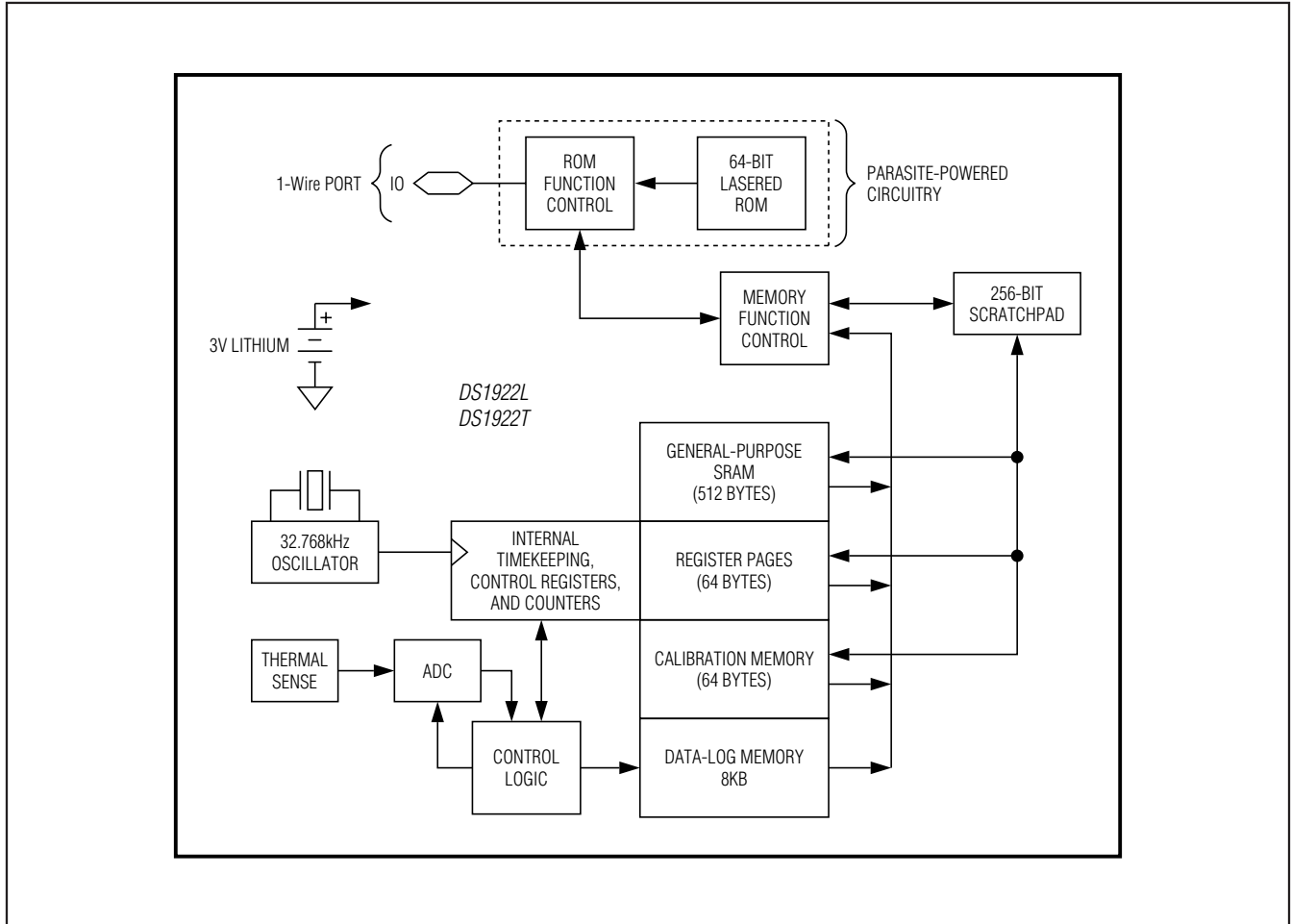

Figure 1. Block Diagram

# DS1922L/DS1922T

## Temperature Logger iButton with 8KB Data-Log Memory

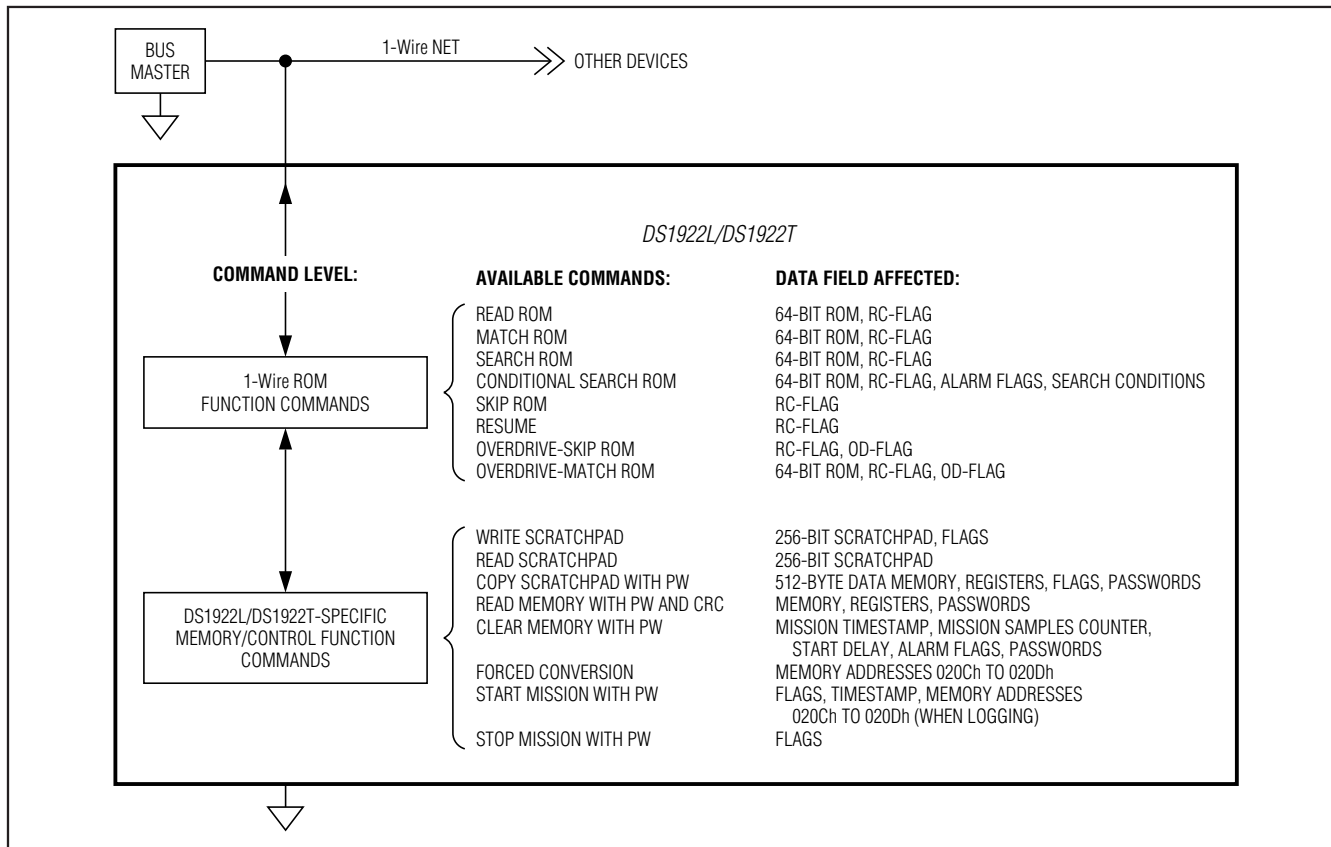

Figure 2. Hierarchical Structure for 1-Wire Protocol

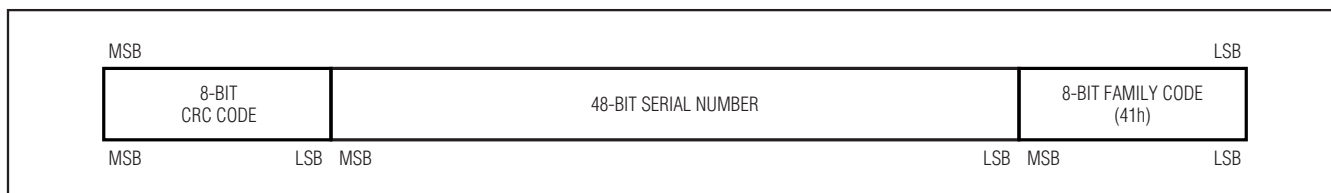

Figure 3. 64-Bit Lasered ROM

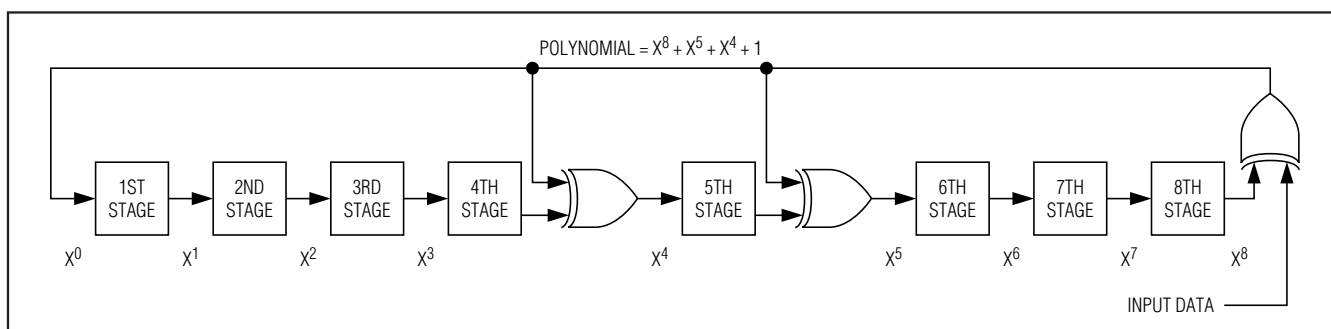

Figure 4. 1-Wire CRC Generator



# DS1922L/DS1922T

## Temperature Logger *i*Button with 8KB Data-Log Memory

### Memory

Figure 5 shows the DS1922L/DS1922T memory map. Pages 0 to 15 contain 512 bytes of general-purpose SRAM. The various registers to set up and control the device fill pages 16 and 17, called register pages 1 and 2 (see Figure 6 for details). Pages 18 and 19 provide storage space for calibration data. They can alternatively be used as an extension of the general-purpose memory. The data-log logging memory starts at address 1000h (page 128) and extends over 256 pages. The memory pages 20 to 127 are reserved for future extensions. The scratchpad is an additional page that acts as a buffer when writing to the SRAM memory or the register pages. The data memory can be written at any time. The calibration memory holds data from the device calibration that can be used to further improve the accuracy of 11-bit temperature readings. See the

*Software Correction Algorithm for Temperature* section for details. The last byte of the calibration memory page stores an 8-bit CRC of the preceding 31 bytes. Page 19 is an exact copy of the data in page 18. While calibration memory can be overwritten by the user, this is not recommended. See the *Security by Password* section for ways to protect the memory. The access type for the register pages is register-specific and depends on whether the device is programmed for a mission. Figure 6 shows the details. The data-log memory is read only for the user. It is written solely under supervision of the on-chip control logic. Due to the special behavior of the write access logic (write scratchpad, copy scratchpad), it is recommended to only write full pages at a time. This also applies to the register pages and the calibration memory. See the *Address Registers and Transfer Status* section for details.

ADDRESS		
	<b>32-BYTE INTERMEDIATE STORAGE SCRATCHPAD</b>	
0000h TO 001Fh	<b>32-BYTE GENERAL-PURPOSE SRAM (R/W)</b>	PAGE 0
0020h TO 01FFh	<b>GENERAL-PURPOSE SRAM (R/W)</b>	PAGES 1 TO 15
0200h TO 021Fh	<b>32-BYTE REGISTER PAGE 1</b>	PAGE 16
0220h TO 023Fh	<b>32-BYTE REGISTER PAGE 2</b>	PAGE 17
0240h TO 025Fh	<b>CALIBRATION MEMORY PAGE 1 (R/W)</b>	PAGE 18
0260h TO 027Fh	<b>CALIBRATION MEMORY PAGE 2 (R/W)</b>	PAGE 19
0280h TO 0FFFh	(RESERVED FOR FUTURE EXTENSIONS)	PAGES 20 TO 127
1000h TO 2FFFh	<b>DATA-LOG MEMORY (READ ONLY)</b>	PAGES 128 TO 383

Figure 5. Memory Map

# DS1922L/DS1922T

## Temperature Logger *i*Button with 8KB Data-Log Memory

ADDRESS	BIT 7	BIT 6	BIT 5	BIT 4	BIT 3	BIT 2	BIT 1	BIT 0	FUNCTION	ACCESS*	
0200h	0	10 Seconds			Single Seconds				Real-Time Clock Registers	R/W	R
0201h	0	10 Minutes			Single Minutes						
0202h	0	12/24	20 Hour AM/PM	10 Hour	Single Hours						
0203h	0	0	10 Date		Single Date						
0204h	CENT	0	0	10 Months	Single Months						
0205h	10 Years				Single Years				Sample Rate	R/W	R
0206h	Low Byte										
0207h	0	0	High Byte								
0208h	Low Threshold								Temperature Alarms	R/W	R
0209h	High Threshold										
020Ah	(No Function with the DS1922L/DS1922T)								—	R/W	R
020Bh	(No Function with the DS1922L/DS1922T)										
020Ch	Low Byte			0	0	0	0	0	Latest Temperature	R	R
020Dh	High Byte										
020Eh	(No Function with the DS1922L/DS1922T)								—	R	R
020Fh	(No Function with the DS1922L/DS1922T)										
0210h	0	0	0	0	0	0	ETHA	ETLA	Temperature Alarm Enable	R/W	R
0211h	1	1	1	1	1	1	0	0	—	R/W	R
0212h	0	0	0	0	0	0	EHSS	EOSC	RTC Control	R/W	R
0213h	1	1	SUTA	RO	(X)	TLFS	0	ETL	Mission Control	R/W	R
0214h	BOR	1	1	1	0	0	THF	TLF	Alarm Status	R	R
0215h	1	1	0	WFTA	MEMCLR	0	MIP	0	General Status	R	R
0216h	Low Byte								Start Delay Counter	R/W	R
0217h	Center Byte										
0218h	High Byte										

*\*The left entry in the ACCESS column is valid between missions. The right entry shows the applicable access type while a mission is in progress.*

Figure 6. Register Pages Map

# DS1922L/DS1922T

## Temperature Logger *i*Button with 8KB Data-Log Memory

ADDRESS	BIT 7	BIT 6	BIT 5	BIT 4	BIT 3	BIT 2	BIT 1	BIT 0	FUNCTION	ACCESS*	
0219h	0	10 Seconds			Single Seconds				Mission Timestamp	R	R
021Ah	0	10 Minutes			Single Minutes						
021Bh	0	12/24	20 Hour AM/PM	10 Hour	Single Hours						
021Ch	0	0	10 Date		Single Date						
021Dh	CENT	0	0	10 Months	Single Months						
021Eh	10 Years			Single Years							
021Fh	(No Function; Reads 00h)								—	R	R
0220h	Low Byte								Mission Samples Counter	R	R
0221h	Center Byte										
0222h	High Byte										
0223h	Low Byte								Device Samples Counter	R	R
0224h	Center Byte										
0225h	High Byte										
0226h	Configuration Code								Flavor	R	R
0227h	EPW								PW Control	R/W	R
0228h	First Byte								Read Access Password	W	—
...	...										
022Fh	Eighth Byte										
0230h	First Byte										
...	...								Full Access Password	W	—
0237h	Eighth Byte										
0238h	(No Function; All These Bytes Read 00h)								—	R	R
...											
023Fh											

*\*The left entry in the ACCESS column is valid between missions. The right entry shows the applicable access type while a mission is in progress.*

Figure 6. Register Pages Map (continued)

# DS1922L/DS1922T

## Temperature Logger iButton with 8KB Data-Log Memory

### Detailed Register Descriptions

#### Timekeeping and Calendar

The RTC and calendar information is accessed by reading/writing the appropriate bytes in the register page, address 0200h to 0205h. For readings to be valid, all RTC registers must be read sequentially starting at address 0200h. Some of the RTC bits are set to 0. These bits always read 0 regardless of how they are written. The number representation of the RTC registers is binary-coded decimal (BCD) format.

The DS1922L/DS1922T's RTC can run in either 12hr or 24hr mode. Bit 6 of the Hours register (address 0202h) is defined as the 12hr- or 24hr-mode select bit. When high, the 12hr mode is selected. In the 12hr mode, bit 5 is the AM/PM bit with logic 1 being PM. In the 24hr mode, bit 5 is the 20hr bit (20hr to 23hr). The CENT bit, bit 7 of the Months register, can be written by the user. This bit changes its state when the years counter transitions from 99 to 00.

The calendar logic is designed to automatically compensate for leap years. For every year value that is

either 00 or a multiple of 4, the device adds a 29th of February. This works correctly up to (but not including) the year 2100.

#### Sample Rate

The content of the Sample Rate register (addresses 0206h, 0207h) specifies the time elapse (in seconds if EHSS = 1, or minutes if EHSS = 0) between two temperature-logging events. The sample rate can be any value from 1 to 16,383, coded as an unsigned 14-bit binary number. If EHSS = 1, the shortest time between logging events is 1s and the longest (sample rate = 3FFFh) is 4.55hr. If EHSS = 0, the shortest is 1min and the longest time is 273.05hr (sample rate = 3FFFh). The EHSS bit is located in the RTC Control register at address 0212h. It is important that the user sets the EHSS bit accordingly while setting the Sample Rate register. **Writing a sample rate of 0000h results in a sample rate = 0001h, causing the DS1922L/DS1922T to log the temperature either every minute or every second depending upon the state of the EHSS bit.**

#### RTC Registers Bitmap

ADDRESS	BIT 7	BIT 6	BIT 5	BIT 4	BIT 3	BIT 2	BIT 1	BIT 0
0200h	0	10 Seconds			Single Seconds			
0201h	0	10 Minutes			Single Minutes			
0202h	0	12/24	20 Hour AM/PM	10 Hour	Single Hours			
0203h	0	0	10 Date		Single Date			
0204h	CENT	0	0	10 Months	Single Months			
0205h	10 Years				Single Years			

**Note:** During a mission, there is only read access to these registers. Bit cells marked "0" always read 0 and cannot be written to 1.

#### Sample Rate Register Bitmap

ADDRESS	BIT 7	BIT 6	BIT 5	BIT 4	BIT 3	BIT 2	BIT 1	BIT 0
0206h	Sample Rate Low							
0207h	0	0	Sample Rate High					

**Note:** During a mission, there is only read access to these registers. Bit cells marked "0" always read 0 and cannot be written to 1.

# DS1922L/DS1922T

## Temperature Logger *i*Button with 8KB Data-Log Memory

### Temperature Conversion

The DS1922L's temperature range begins at -40°C and ends at +85°C. The temperature range for the DS1922T begins at 0 and ends at +125°C. Temperature values are represented as an 8-bit or 16-bit unsigned binary number with a resolution of 0.5°C in 8-bit mode and 0.0625°C in 16-bit mode.

The higher temperature byte TRH is always valid. In 16-bit mode, only the three highest bits of the lower byte TRL are valid. The five lower bits all read 0. TRL is undefined if the device is in 8-bit temperature mode. An out-of-range temperature reading is indicated as 00h or 0000h when too cold and FFh or FFE0h when too hot.

With TRH and TRL representing the decimal equivalent of a temperature reading, the temperature value is calculated as:

$$\vartheta(^{\circ}\text{C}) = \text{TRH}/2 - 41 + \text{TRL}/512 \text{ (16-bit mode, TLFS} = 1, \text{ see address 0213h)}$$

$$\vartheta(^{\circ}\text{C}) = \text{TRH}/2 - 41 \text{ (8-bit mode, TLFS} = 0, \text{ see address 0213h)}$$

This equation is valid for converting temperature readings stored in the data-log memory as well as for data read from the Latest Temperature Conversion Result register. The “-41” applies to the DS1922L. For the DS1922T, use “-1” instead of “-41.”

To specify the temperature alarm thresholds, the previous equations are resolved to:

$$\text{TALM} = 2 \times \vartheta(^{\circ}\text{C}) + 82$$

The “+82” applies to the DS1922L. For the DS1922T, use “+2.” Because the temperature alarm threshold is only one byte, the resolution or temperature increment is limited to 0.5°C. The TALM value must be converted into hexadecimal format before it can be written to one of the Temperature Alarm Threshold registers (Low Alarm address 0208h; High Alarm address 0209h). Independent of the conversion mode (8-bit or 16-bit), only the most significant byte of a temperature conversion is used to determine whether an alarm is generated.

### Latest Temperature Conversion Result Register Bitmap

ADDRESS	BIT 7	BIT 6	BIT 5	BIT 4	BIT 3	BIT 2	BIT 1	BIT 0	BYTE
020Ch	T2	T1	T0	0	0	0	0	0	TRL
020Dh	T10	T9	T8	T7	T6	T5	T4	T3	TRH

Table 1. Temperature Conversion Examples

MODE	TRH		TRL		$\vartheta(^{\circ}\text{C})$	
	HEX	DECIMAL	HEX	DECIMAL	DS1922L	DS1922T
8-Bit	54h	84	—	—	1.0	41.0
8-Bit	17h	23	—	—	-29.5	10.5
16-Bit	54h	84	00h	0	1.000	41.000
16-Bit	17h	23	60h	96	-29.3125	10.6875

Table 2. Temperature Alarm Threshold Examples

$\vartheta(^{\circ}\text{C})$	TALM (DS1922T)	
	HEX	DECIMAL
65.5	85h	133
30.0	3Eh	62

$\vartheta(^{\circ}\text{C})$	TALM (DS1922L)	
	HEX	DECIMAL
25.5	85h	133
-10.0	3Eh	62

# DS1922L/DS1922T

## Temperature Logger iButton with 8KB Data-Log Memory

### Temperature Sensor Control Register Bitmap

ADDRESS	BIT 7	BIT 6	BIT 5	BIT 4	BIT 3	BIT 2	BIT 1	BIT 0
0210h	0	0	0	0	0	0	ETHA	ETLA

**Note:** During a mission, there is only read access to this register. Bits 2 to 7 have no function. They always read 0 and cannot be written to 1.

### RTC Control Register Bitmap

ADDRESS	BIT 7	BIT 6	BIT 5	BIT 4	BIT 3	BIT 2	BIT 1	BIT 0
0212h	0	0	0	0	0	0	EHSS	EOSC

**Note:** During a mission, there is only read access to this register. Bits 2 to 7 have no function. They always read 0 and cannot be written to 1.

### Temperature Sensor Alarm

The DS1922L/DS1922T have two Temperature Alarm Threshold registers (address 0208h, 0209h) to store values that determine whether a critical temperature has been reached. A temperature alarm is generated if the device measures an alarming temperature and the alarm signaling is enabled. The bits ETLA and ETHA that enable the temperature alarm are located in the Temperature Sensor Control register. The temperature alarm flags TLF and THF are found in the Alarm Status register at address 0214h.

**Bit 1: Enable Temperature High Alarm (ETHA).** This bit controls whether, during a mission, the temperature high alarm flag (THF) can be set, if a temperature conversion results in a value equal to or higher than the value in the Temperature High Alarm Threshold register. If ETHA is 1, temperature high alarms are enabled. If ETHA is 0, temperature high alarms are not generated.

**Bit 0: Enable Temperature Low Alarm (ETLA).** This bit controls whether, during a mission, the temperature low alarm flag (TLF) can be set, if a temperature conversion results in a value equal to or lower than the value in the Temperature Low Alarm Threshold register. If ETLA is 1, temperature low alarms are enabled. If ETLA is 0, temperature low alarms are not generated.

### RTC Control

To minimize the power consumption of the DS1922L/DS1922T, the RTC oscillator should be turned off when these devices are not in use. The oscillator on/off bit is located in the RTC Control register. This register also includes the EHSS bit, which determines whether the sample rate is specified in seconds or minutes.

**Bit 1: Enable High-Speed Sample (EHSS).** This bit controls the speed of the sample rate counter. When set to logic 0, the sample rate is specified in minutes. When set to logic 1, the sample rate is specified in seconds.

**Bit 0: Enable Oscillator (EOSC).** This bit controls the crystal oscillator of the RTC. When set to logic 1, the oscillator starts. When written to logic 0, the oscillator stops and the device is in a low-power data-retention mode. This bit must be 1 for normal operation. A Forced Conversion or Start Mission command automatically starts the RTC by changing the EOSC bit to logic 1.

# DS1922L/DS1922T

## Temperature Logger *i*Button with 8KB Data-Log Memory

**Mission Control Register Bitmap**

ADDRESS	BIT 7	BIT 6	BIT 5	BIT 4	BIT 3	BIT 2	BIT 1	BIT 0
0213h	1	1	SUTA	RO	(X)	TLFS	0	ETL

**Note:** During a mission, there is only read access to this register. Bits 6 and 7 have no function. They always read 1 and cannot be written to 0. Bits 1 and 3 control functions that are not available with the DS1922L/DS1922T. Bit 1 must be set to 0. Under this condition the setting of bit 3 becomes a “don’t care.”

### **Mission Control**

The DS1922L/DS1922T are set up for operation by writing appropriate data to the special function registers, which are located in the two register pages. The settings in the Mission Control register determine which format (8 or 16 bits) applies and whether old data can be overwritten by new data once the data-log memory is full. An additional control bit can be set to tell the DS1922L/DS1922T to wait with logging data until a temperature alarm is encountered.

**Bit 5: Start Mission Upon Temperature Alarm (SUTA).** This bit specifies whether a mission begins immediately (includes delayed start) or if a temperature alarm is required to start the mission. If this bit is 1, the device performs an 8-bit temperature conversion at the selected sample rate and begins with data logging only if an alarming temperature (high alarm or low alarm) was found. The first logged temperature is when the alarm occurred. However, the mission sample counter does not increment. This functionality is guaranteed by design and not production tested.

**Bit 4: Rollover Control (RO).** This bit controls whether, during a mission, the data-log memory is overwritten with new data or whether data logging is stopped once the data-log memory is full. Setting this bit to 1 enables the rollover and data logging continues at the beginning, overwriting previously collected data. If this bit is 0, the logging and conversions stop once the data-log memory is full. However, the RTC continues to run and the MIP bit remains set until the Stop Mission command is performed.

**Bit 2: Temperature Logging Format Selection (TLFS).** This bit specifies the format used to store temperature readings in the data-log memory. If this bit is 0, the data is stored in 8-bit format. If this bit is 1, the 16-bit format is used (higher resolution). With 16-bit format, the most significant byte is stored at the lower address.

**Bit 0: Enable Temperature Logging (ETL).** To set up the device for a temperature-logging mission, this bit must be set to logic 1. The recorded temperature values start at address 1000h.

# DS1922L/DS1922T

## Temperature Logger iButton with 8KB Data-Log Memory

### Alarm Status Register Bitmap

ADDRESS	BIT 7	BIT 6	BIT 5	BIT 4	BIT 3	BIT 2	BIT 1	BIT 0
0214h	BOR	1	1	1	0	0	THF	TLF

**Note:** There is only read access to this register. Bits 4 to 6 have no function. They always read 1. Bits 2 and 3 have no function with the DS1922L/DS1922T. They always read 0. The alarm status bits are cleared simultaneously when the Clear Memory Function is invoked. See the Memory and Control Function Commands section for details.

### General Status Register Bitmap

ADDRESS	BIT 7	BIT 6	BIT 5	BIT 4	BIT 3	BIT 2	BIT 1	BIT 0
0215h	1	1	0	WFTA	MEMCLR	0	MIP	0

**Note:** There is only read access to this register. Bits 0, 2, 5, 6, and 7 have no function.

### Alarm Status

The fastest way to determine whether a programmed temperature threshold was exceeded during a mission is by reading the Alarm Status register. In a networked environment that contains multiple DS1922L/DS1922T iButtons, the devices that encountered an alarm can quickly be identified by means of the Conditional Search command (see the *1-Wire ROM Function Commands* section). The temperature alarm only occurs if enabled (see the *Temperature Sensor Alarm* section). The BOR alarm is always enabled.

**Bit 7: Battery-On Reset Alarm (BOR).** If this bit reads 1, the device has performed a power-on reset. This indicates that the device has experienced a shock big enough to interrupt the internal battery power supply. The device can still appear functional, but it has lost its factory calibration. Any data found in the data-log memory should be disregarded.

**Bit 1: Temperature High Alarm Flag (THF).** If this bit reads 1, there was at least one temperature conversion during a mission revealing a temperature equal to or higher than the value in the Temperature High Alarm register. A forced conversion can affect the THF bit. This bit can also be set with the initial alarm in the SUTA = 1 mode.

**Bit 0: Temperature Low Alarm Flag (TLF).** If this bit reads 1, there was at least one temperature conversion during a mission revealing a temperature equal to or lower than the value in the Temperature Low Alarm register. A forced conversion can affect the TLF bit. This bit can also be set with the initial alarm in the SUTA = 1 mode.

### General Status

The information in the General Status register tells the host computer whether a mission-related command was executed successfully. Individual status bits indicate whether the DS1922L/DS1922T are performing a mission, waiting for a temperature alarm to trigger the logging of data, or whether the data from the latest mission has been cleared.

**Bit 4: Waiting for Temperature Alarm (WFTA).** If this bit reads 1, the Mission Start Upon Temperature Alarm was selected and the Start Mission command was successfully executed, but the device has not yet experienced the temperature alarm. This bit is cleared after a temperature alarm event, but is not affected by the Clear Memory command. Once set, WFTA remains set if a mission is stopped before a temperature alarm occurs. To clear WFTA manually before starting a new mission, set the high temperature alarm (address 0209h) to -40°C and perform a forced conversion.

**Bit 3: Memory Cleared (MEMCLR).** If this bit reads 1, the Mission Timestamp, Mission Samples Counter, and all the alarm flags of the Alarm Status register have been cleared in preparation of a new mission. Executing the Clear Memory command clears these memory sections. The MEMCLR bit returns to 0 as soon as a new mission is started by using the Start Mission command. The memory must be cleared for a mission to start.

**Bit 1: Mission in Progress (MIP).** If this bit reads 1, the device has been set up for a mission and this mission is still in progress. The MIP bit returns from logic 1 to logic 0 when a mission is ended. See the *Start Mission with Password* and *Stop Mission with Password* sections.



# DS1922L/DS1922T

## Temperature Logger *i*Button with 8KB Data-Log Memory

### Mission Start Delay Counter Register Bitmap

ADDRESS	BIT 7	BIT 6	BIT 5	BIT 4	BIT 3	BIT 2	BIT 1	BIT 0
0216h	Delay Low Byte							
0217h	Delay Center Byte							
0218h	Delay High Byte							

**Note:** During a mission, there is only read access to this register.

### Mission Timestamp Register Bitmap

ADDRESS	BIT 7	BIT 6	BIT 5	BIT 4	BIT 3	BIT 2	BIT 1	BIT 0
0219h	0	10 Seconds			Single Seconds			
021Ah	0	10 Minutes			Single Minutes			
021Bh	0	12/24	20 Hours AM/PM	10 Hours	Single Hours			
021Ch	0	0	10 Date		Single Date			
021Dh	CENT	0	0	10 Months	Single Months			
021Eh	10 Years				Single Years			

**Note:** There is only read access to this register.

### Mission Samples Counter Register Bitmap

ADDRESS	BIT 7	BIT 6	BIT 5	BIT 4	BIT 3	BIT 2	BIT 1	BIT 0
0220h	Low Byte							
0221h	Center Byte							
0222h	High Byte							

**Note:** There is only read access to this register.

### Mission Start Delay

The content of the Mission Start Delay Counter register tells how many minutes must expire from the time a mission was started until the first measurement of the mission takes place (SUTA = 0) or until the device starts testing the temperature for a temperature alarm (SUTA = 1). The Mission Start Delay is stored as an unsigned 24-bit integer number. The maximum delay is 16,777,215min, equivalent to 11,650 days or roughly 31 years. If the start delay is nonzero and the SUTA bit is set to 1, first the delay must expire before the device starts testing for temperature alarms to begin logging data.

For a typical mission, the Mission Start Delay is 0. If a mission is too long for a single DS1922L/DS1922T to store all readings at the selected sample rate, one can use several devices and set the Mission Start Delay for the second device to start recording as soon as the memory of the first device is full, and so on. The RO bit in the Mission Control register (address 0213h) must be set to 0 to prevent overwriting of collected data once the data-log memory is full.

### Mission Timestamp

The Mission Timestamp register indicates the date and time of the first temperature sample of the mission. There is only read access to the Mission Timestamp register.

### Mission Progress Indicator

Depending on settings in the Mission Control register (address 0213h), the DS1922L/DS1922T log temperature in 8-bit or 16-bit format. The Mission Samples Counter together with the starting address and the logging format (8 or 16 bits) provide the information to identify valid blocks of data that have been gathered during the current (MIP = 1) or latest mission (MIP = 0). See the *Data-Log Memory Usage* section for an illustration.

The number read from the Mission Samples Counter indicates how often the DS1922L/DS1922T woke up during a mission to measure temperature. The number format is 24-bit unsigned integer. The Mission Samples Counter is reset through the Clear Memory command.

# DS1922L/DS1922T

## Temperature Logger iButton with 8KB Data-Log Memory

### Device Samples Counter Register Bitmap

ADDRESS	BIT 7	BIT 6	BIT 5	BIT 4	BIT 3	BIT 2	BIT 1	BIT 0
0223h	Low Byte							
0224h	Center Byte							
0225h	High Byte							

**Note:** There is only read access to this register.

### Device Configuration Register Bitmap

ADDRESS	BIT 7	BIT 6	BIT 5	BIT 4	BIT 3	BIT 2	BIT 1	BIT 0	PART
0226h	0	0	0	0	0	0	0	0	DS2422
	0	0	1	0	0	0	0	0	DS1923
	0	1	0	0	0	0	0	0	DS1922L
	0	1	1	0	0	0	0	0	DS1922T
	1	0	0	0	0	0	0	0	DS1922E

**Note:** There is only read access to this register.

### Password Control Register Bitmap

ADDRESS	BIT 7	BIT 6	BIT 5	BIT 4	BIT 3	BIT 2	BIT 1	BIT 0
0227h	EPW							

**Note:** During a mission, there is only read access to this register.

### Other Indicators

The Device Samples Counter register is similar to the Mission Samples Counter register. During a mission this counter increments whenever the DS1922L/DS1922T wake up to measure and log data and when these devices are testing for a temperature alarm in SUTA mode. Between missions, the counter increments whenever the Forced Conversion command is executed. This way the Device Samples Counter register functions like a gas gauge for the battery that powers the iButton.

The Device Samples Counter register is reset to zero when the iButton is assembled. The number format is 24-bit unsigned integer. The maximum number that can be represented in this format is 16,777,215. Due to the calibration and tests at the factory, new devices can have a count value of up to 35,000. The typical value is well below 10,000.

The code in the Device Configuration register allows the master to distinguish between the DS2422 chip and different versions of the DS1922 iButtons. The *Device Configuration Register Bitmap* shows the codes assigned to the various devices.

### Security by Password

The DS1922L/DS1922T are designed to use two passwords that control read access and full access. Reading from or writing to the scratchpad as well as the Forced Conversion command does not require a password. The password must be transmitted immediately after the command code of the memory or control function. If password checking is enabled, the password transmitted is compared to the passwords stored in the device. The data pattern stored in the Password Control register determines whether password checking is enabled.

To enable password checking, the EPW bits need to form a binary pattern of 10101010 (AAh). The default pattern of EPW is different from AAh. If the EPW pattern is different from AAh, any pattern is accepted as long as it has a length of exactly 64 bits. Once enabled, changing the passwords and disabling password checking requires the knowledge of the current full-access password.