



Chipsmall Limited consists of a professional team with an average of over 10 year of expertise in the distribution of electronic components. Based in Hongkong, we have already established firm and mutual-benefit business relationships with customers from,Europe,America and south Asia,supplying obsolete and hard-to-find components to meet their specific needs.

With the principle of “Quality Parts,Customers Priority,Honest Operation,and Considerate Service”,our business mainly focus on the distribution of electronic components. Line cards we deal with include Microchip,ALPS,ROHM,Xilinx,Pulse,ON,Everlight and Freescale. Main products comprise IC,Modules,Potentiometer,IC Socket,Relay,Connector.Our parts cover such applications as commercial,industrial, and automotives areas.

We are looking forward to setting up business relationship with you and hope to provide you with the best service and solution. Let us make a better world for our industry!



## Contact us

Tel: +86-755-8981 8866 Fax: +86-755-8427 6832

Email & Skype: info@chipsmall.com Web: www.chipsmall.com

Address: A1208, Overseas Decoration Building, #122 Zhenhua RD., Futian, Shenzhen, China



## Fast Current Mirror

### General Description

The DS3920 precision current mirror is designed for avalanche photodiode (APD) and PIN photodiode biasing and monitoring applications. The device offers a current clamp to limit current through the APD and a current mirror output that produces a signal proportional (5:1) to the APD current. A diode is also provided to limit the voltage at the current mirror output.

The device accepts a +2.97V to +76V current mirror supply voltage. Internal current limiting (4.4mA or 20mA, typ) protects the monitored device from a short circuit to ground. The provided internal clamp diode protects the current mirror output from overvoltage. Additionally, the device features thermal shutdown if the die temperature reaches +150°C.

The device is available in a 6-pin SOT23 package, and operates over the -40°C to +85°C extended temperature range.

### Features

- ◆ **Wide Voltage Input Range: 2.97V to 76V**
- ◆ **Current Monitor**
  - ◇ **Wide 250nA to 2mA Range**
  - ◇ **5:1 Mirror Ratio**
  - ◇ **Fast 50ns Time Constant**
- ◆ **Current Clamp (4.4mA or 20mA, typ)**
- ◆ **Voltage Clamp Protects Subsequent Output Circuitry**
- ◆ **6-Pin SOT23 (MAX4007 Compatible)**

### Applications

Avalanche Photodiode (APD) Biasing

PIN Photodiode Monitoring

GEAPON, GPON, 10GEAPON, XGPON: ONU and OLT

*Ordering Information appears at end of data sheet.*

### Typical Application Circuit

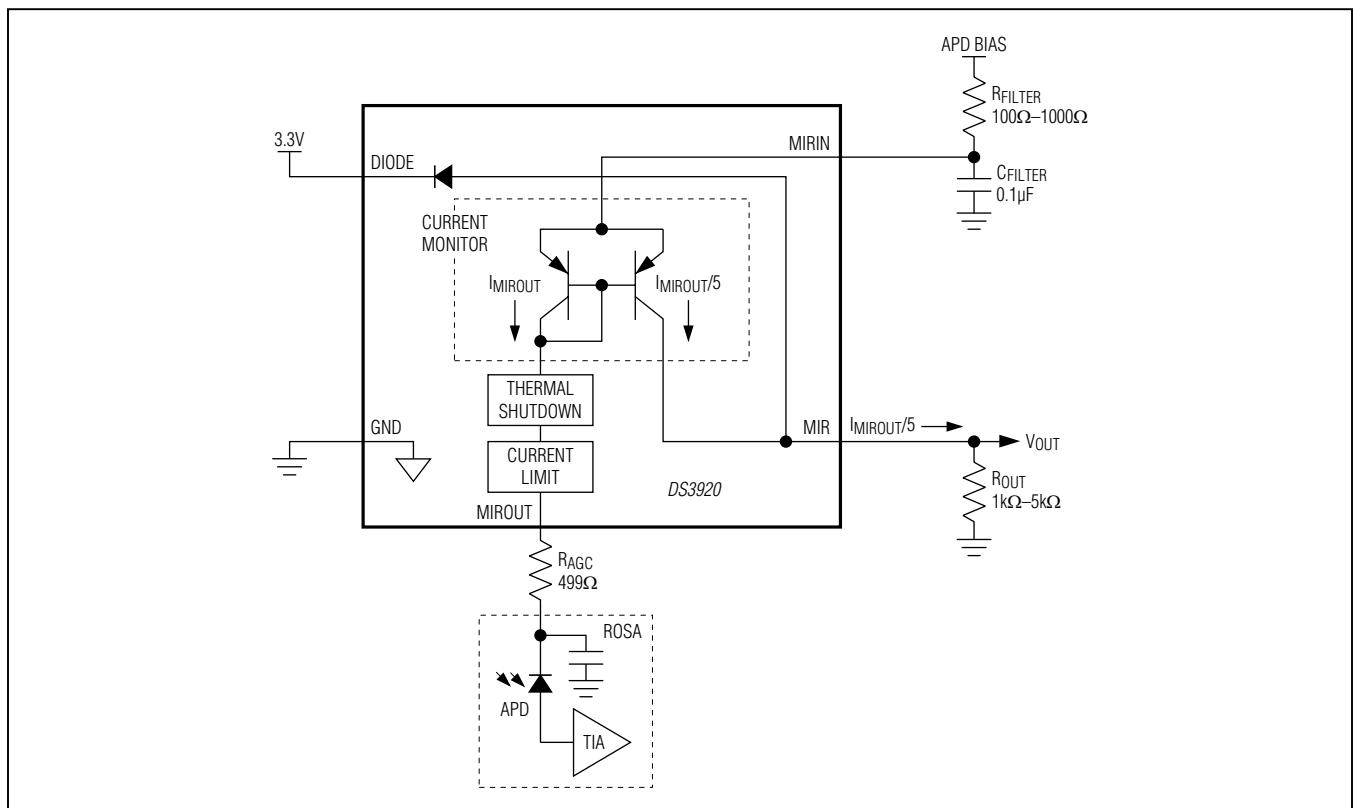

For related parts and recommended products to use with this part, refer to: [www.maximintegrated.com/DS3920.related](http://www.maximintegrated.com/DS3920.related)

## Fast Current Mirror

### ABSOLUTE MAXIMUM RATINGS

Voltage Range on MIRIN, MIROUT,  
and DIODE Relative to GND .....-0.3V to +80V  
Voltage Range on MIR  
Relative to GND .....-0.3V to ( $V_{DIODE} + 0.6V$ )  
Continuous Power Dissipation ( $T_A = +70^\circ C$ )  
SOT23 (derate 13.4mW/ $^\circ C$  above  $+70^\circ C$ )..... 1072.4mW

Operating Junction Temperature Range ..... -40 $^\circ C$  to +150 $^\circ C$   
Storage Temperature Range..... -55 $^\circ C$  to +135 $^\circ C$   
Lead Temperature (soldering, 10s) .....+300 $^\circ C$   
Soldering Temperature (reflow) .....+260 $^\circ C$

*Stresses beyond those listed under "Absolute Maximum Ratings" may cause permanent damage to the device. These are stress ratings only, and functional operation of the device at these or any other conditions beyond those indicated in the operational sections of the specifications is not implied. Exposure to absolute maximum rating conditions for extended periods may affect device reliability.*

### ELECTRICAL CHARACTERISTICS

( $V_{MIRIN} = 2.97V$  to 76V,  $T_A = -40^\circ C$  to  $+85^\circ C$ , unless otherwise noted.)

PARAMETER	SYMBOL	CONDITIONS	MIN	TYP	MAX	UNITS
MIRIN Voltage	$V_{MIRIN}$		2.97		76	V
MIRIN Current	$I_{MIRIN}$	$I_{MIROUT} = 2.5mA$			4.4	mA
Diode Forward Current	$I_{DF}$				5	mA
Diode Forward Voltage	$V_{DF}$	$I_{DF} = 100\mu A, T_A = +25^\circ C$		0.6		V
		$I_{DF} = 5mA, T_A = +25^\circ C$			1.25	
MIROUT Current Limit	$I_{MIROUT}$	DS3920T-001 version, $T_A = +25^\circ C$	10	20	40	mA
		DS3920T-002 version, $T_A = +25^\circ C$	2.8	4.4	8	
MIROUT Series Resistance	$R_{AGC}$	(Note 1)	100			$\Omega$
MIR to MIROUT Ratio	$K_{MIR}$	1 $\mu A$ to 2.5mA	0.190	0.200	0.210	A/A
		$I_{MIROUT} > 2.5mA$	0.180	0.200	0.220	
Power-Supply Rejection Ratio	$(\Delta I_{MIR}/I_{MIR}) / \Delta V_{MIRIN}$	$V_{MIRIN} = 3V$ (Note 2)		4800	15,000	ppm/V
		$V_{MIRIN} = 30V$ or 60V (Notes 2, 3)		100	500	
MIR Current Rise Time (20%/80%)	$t_{RC}$	(Note 4)		30		ns
Thermal Shutdown Temperature	$T_{SHDN}$	(Note 3)		+150		$^\circ C$
Thermal Shutdown Hysteresis	$T_{HYST}$	(Note 3)		20		$^\circ C$

**Note 1:** See the [Typical Application Circuit](#).

**Note 2:** 1V DC change applied to MIRIN; 100 $\mu A$  at MIROUT; 4.99k $\Omega$  load to ground on MIR.

**Note 3:** Guaranteed by design; not production tested.

**Note 4:** Rising MIROUT transition from 10 $\mu A$  to 1mA; 15V <  $V_{OUT}$  < 76V.

## Fast Current Mirror

### Typical Operating Characteristics

( $T_A = +25^\circ\text{C}$ , unless otherwise noted.)

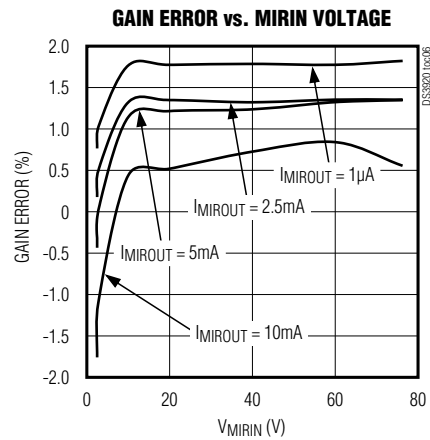
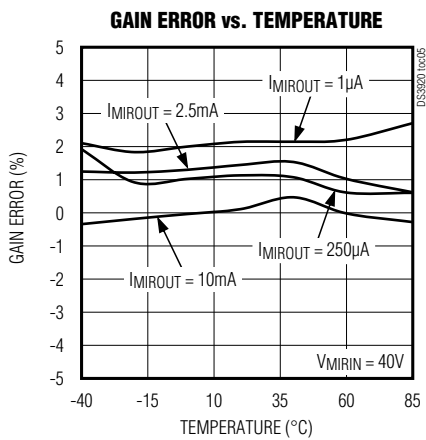
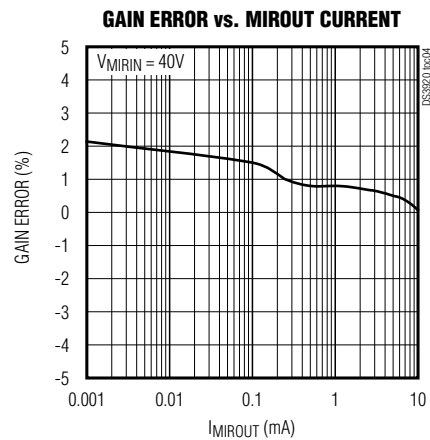
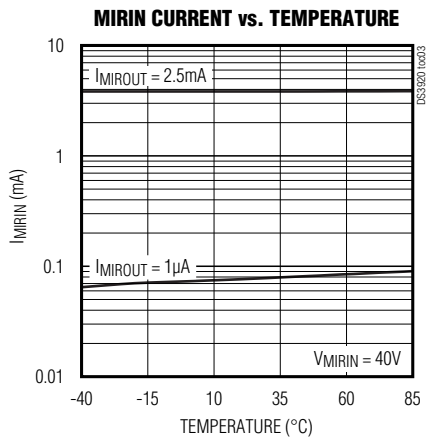
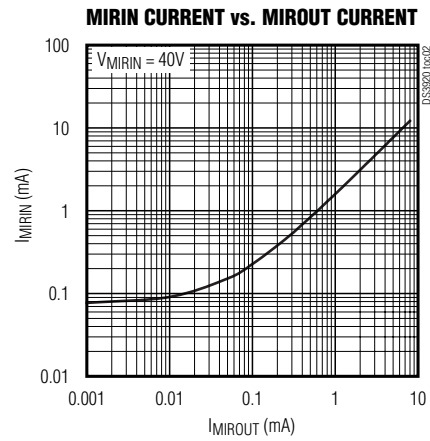
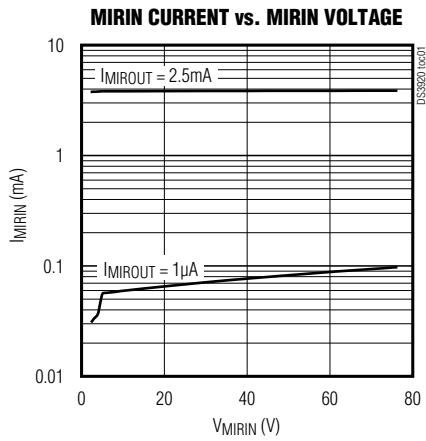

## Fast Current Mirror

### Typical Operating Characteristics (continued)

( $T_A = +25^\circ\text{C}$ , unless otherwise noted.)

**TRANSIENT RESPONSE**  
( $V_{MIRIN} = 40\text{V}$ )

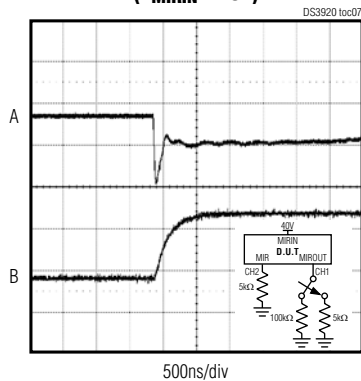

A: CH1, 1V/div,  $I_{MIROUT} = 375\mu\text{A}$  TO  $7.5\text{mA}$   
A: CH2, 5V/div,  $I_{MIR} = 75\mu\text{A}$  TO  $1.5\text{mA}$

**STARTUP DELAY**  
( $V_{BIAS} = 40\text{V}$ ,  $I_{MIROUT} = 1\mu\text{A}$ )

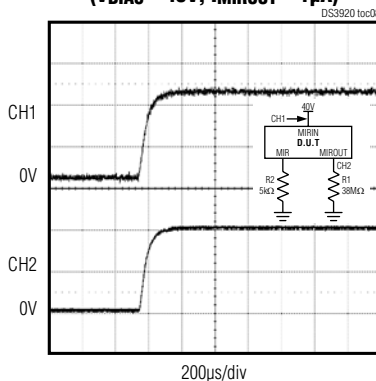

CH1: 20V/div  
CH2: 20V/div

**STARTUP DELAY**  
( $V_{MIRIN} = 40\text{V}$ ,  $I_{MIROUT} = 2.5\text{mA}$ )

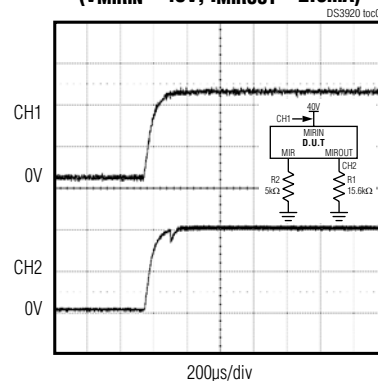

CH1: 20V/div  
CH2: 20V/div

**STARTUP DELAY**  
( $V_{MIRIN} = 5\text{V}$ ,  $I_{MIROUT} = 1\mu\text{A}$ )

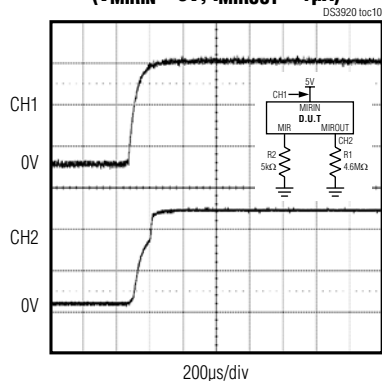

CH1: 2V/div  
CH2: 2V/div

**STARTUP DELAY**  
( $V_{MIRIN} = 5\text{V}$ ,  $I_{MIROUT} = 2.5\text{mA}$ )

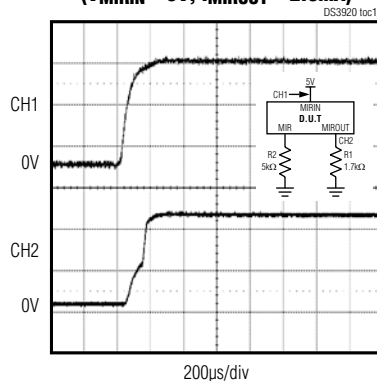

CH1: 2V/div  
CH2: 2V/div

## Fast Current Mirror

### Typical Operating Characteristics (continued)

( $T_A = +25^\circ\text{C}$ , unless otherwise noted.)

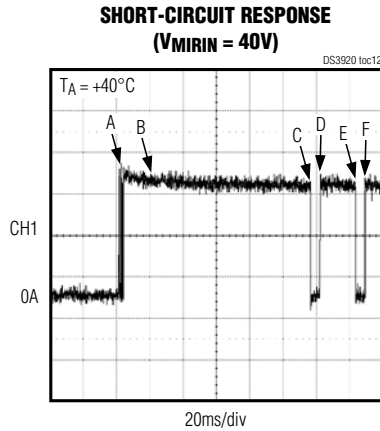

CH1: IMIROUT, 5mA/div  
A: MIROUT SHORTS TO GND THROUGH  $10\Omega$   
B: CURRENT LIMIT ACTIVE  
C: THERMAL SHUTDOWN  
D: POST COOL-DOWN REENTRY  
E: THERMAL SHUTDOWN  
F: POST COOL-DOWN REENTRY

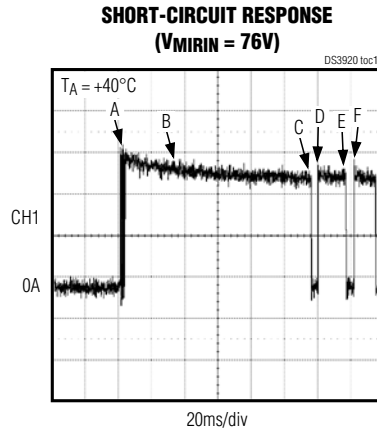

CH1: IMIROUT, 5mA/div  
A: MIROUT SHORTS TO GND THROUGH  $10\Omega$   
B: CURRENT LIMIT ACTIVE  
C: THERMAL SHUTDOWN  
D: POST COOL-DOWN REENTRY  
E: THERMAL SHUTDOWN  
F: POST COOL-DOWN REENTRY

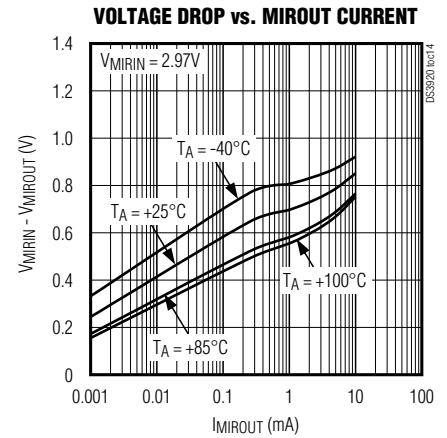

### Pin Configuration

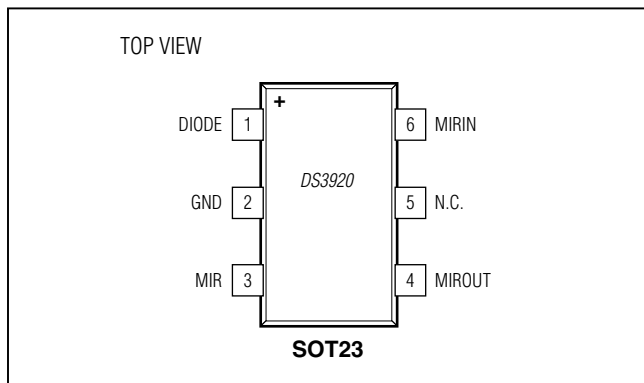

### Pin Description

PIN	NAME	FUNCTION
1	DIODE	Protection Diode. External potential used for voltage clamping of $V_{MIR}$ . If unused, this pin can be left unconnected.
2	GND	Ground
3	MIR	Mirror Current Monitor Output, 5:1 Ratio
4	MIROUT	Current Mirror Voltage Output. Connect to photodiode bias pin. Photodiode provides reference current for the mirror.
5	N.C.	No Connection. Not internally connected.
6	MIRIN	Current Voltage Bias

## Fast Current Mirror

### Detailed Description

The DS3920 provides a fast, precision current mirror for photodiode-monitoring applications. The current mirror is accurate across a large dynamic range. The mirror response time is fast enough to comply with GPON Rx burst-mode monitoring requirements. The device has a built-in current limiting feature to protect photodiodes from large signal inputs, and an included thermal shutdown. A diode is provided to limit the voltage at the MIR output.

#### Current Mirror

The mirror output is typically connected to an analog-to-digital converter (ADC) using a resistor to convert the mirrored current into a voltage. The resistor to ground should be selected so that the ADC's full-scale voltage is reached when the maximum mirrored current is reached. For example, given that the maximum monitored current through the APD is 2mA, 1.25V ADC full scale, and a 5:1 mirror ratio, the correct resistor is approximately 3.2kΩ.

The mirror response time is dominated by the amount of capacitance placed on the output.

#### Current Clamp

The device features a current clamping circuit to protect the photodiode by limiting the amount of current from MIROUT to no more than  $I_{MIROUT}$ . See the [Ordering Information](#) for available current clamp options.

#### Diode Protection

A diode is internally connected from the MIR to DIODE pins. This enables an external voltage applied to DIODE to limit the voltage on MIR. The voltage applied to DIODE should be equal to the desired  $V_{MIR}$  limit minus the diode forward voltage drop, or  $V_{MIR} - V_{DF}$ .

#### Thermal Shutdown

As a safety feature, the device has a thermal shutdown circuit that turns off the MIROUT and MIR currents when the internal die temperature exceeds  $T_{SHDN}$ . The thermal shutdown mechanism has a built-in hysteresis of  $T_{HYST}$ . Thus, the MIROUT and MIR currents resume once the device has cooled to  $T_{SHDN} - T_{HYST}$ .

### Ordering Information

PART	TEMP RANGE	TYP CURRENT LIMIT (mA)	PIN-PACKAGE
DS3920T-001+	-40°C to +85°C	20	6 SOT23
DS3920T-001+T	-40°C to +85°C	20	6 SOT23
DS3920T-002+	-40°C to +85°C	4.4	6 SOT23
DS3920T-002+T	-40°C to +85°C	4.4	6 SOT23

+Denotes a lead(Pb)-free/RoHS-compliant package.

T = Tape and reel.

### Package Information

For the latest package outline information and land patterns (footprints), go to [www.maximintegrated.com/packages](http://www.maximintegrated.com/packages). Note that a "+", "#", or "-" in the package code indicates RoHS status only. Package drawings may show a different suffix character, but the drawing pertains to the package regardless of RoHS status.

PACKAGE TYPE	PACKAGE CODE	OUTLINE NO.	LAND PATTERN NO.
6 SOT23	U6SN+1	<a href="#">21-0058</a>	<a href="#">90-0175</a>

# DS3920

## Fast Current Mirror

### Revision History

REVISION NUMBER	REVISION DATE	DESCRIPTION	PAGES CHANGED
0	3/11	Initial release	—
1	8/11	Changed the MIROUT -002 version current limit value from 2.9mA (typ) to 4.4mA (typ); updated the <i>Electrical Characteristics</i> $I_{MIROUT}$ values for -002 version from 2mA (min), 2.9mA (typ), 4.4mA (max) to 2.8mA (min), 4.4mA (typ), 8mA (max) and added $T_A = +25^{\circ}\text{C}$ test conditions	1, 2, 6
2	12/11	Added $R_{FILTER}$ and $R_{OUT}$ resistor values to the <i>Typical Application Circuit</i>	1



Maxim Integrated cannot assume responsibility for use of any circuitry other than circuitry entirely embodied in a Maxim Integrated product. No circuit patent licenses are implied. Maxim Integrated reserves the right to change the circuitry and specifications without notice at any time. The parametric values (min and max limits) shown in the Electrical Characteristics table are guaranteed. Other parametric values quoted in this data sheet are provided for guidance.