



Chipsmall Limited consists of a professional team with an average of over 10 year of expertise in the distribution of electronic components. Based in Hongkong, we have already established firm and mutual-benefit business relationships with customers from,Europe,America and south Asia,supplying obsolete and hard-to-find components to meet their specific needs.

With the principle of "Quality Parts,Customers Priority,Honest Operation,and Considerate Service",our business mainly focus on the distribution of electronic components. Line cards we deal with include Microchip,ALPS,ROHM,Xilinx,Pulse,ON,Everlight and Freescale. Main products comprise IC,Modules,Potentiometer,IC Socket,Relay,Connector.Our parts cover such applications as commercial,industrial, and automotives areas.

We are looking forward to setting up business relationship with you and hope to provide you with the best service and solution. Let us make a better world for our industry!



Contact us

Tel: +86-755-8981 8866 Fax: +86-755-8427 6832

Email & Skype: info@chipsmall.com Web: www.chipsmall.com

Address: A1208, Overseas Decoration Building, #122 Zhenhua RD., Futian, Shenzhen, China



Schottky Diode Gen²

$$V_{RRM} = 200V$$

$$I_{FAV} = 2 \times 45A$$

$$V_F = 0.86V$$

High Performance Schottky Diode
Low Loss and Soft Recovery
Common Cathode

Part number

DSA90C200HB

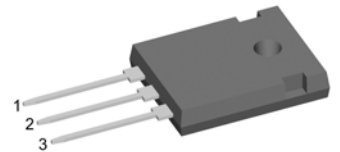

Backside: cathode

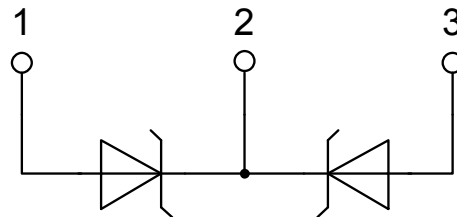

Features / Advantages:

- Very low V_f
- Extremely low switching losses
- Low I_{rm} values
- Improved thermal behaviour
- High reliability circuit operation
- Low voltage peaks for reduced protection circuits
- Low noise switching

Applications:

- Rectifiers in switch mode power supplies (SMPS)
- Free wheeling diode in low voltage converters

Package: TO-247

- Industry standard outline
- RoHS compliant
- Epoxy meets UL 94V-0

Schottky				Ratings		
Symbol	Definition	Conditions	min.	typ.	max.	Unit
V_{RSM}	max. non-repetitive reverse blocking voltage	$T_{VJ} = 25^{\circ}C$			200	V
V_{RRM}	max. repetitive reverse blocking voltage	$T_{VJ} = 25^{\circ}C$			200	V
I_R	reverse current, drain current	$V_R = 200 V$	$T_{VJ} = 25^{\circ}C$		900	μA
		$V_R = 200 V$	$T_{VJ} = 125^{\circ}C$		5	mA
V_F	forward voltage drop	$I_F = 45 A$	$T_{VJ} = 25^{\circ}C$		0.96	V
					1.18	V
		$I_F = 90 A$	$T_{VJ} = 125^{\circ}C$		0.86	V
					1.14	V
I_{FAV}	average forward current	$T_C = 145^{\circ}C$ rectangular $d = 0.5$	$T_{VJ} = 175^{\circ}C$		45	A
V_{FO}	threshold voltage		$T_{VJ} = 175^{\circ}C$		0.52	V
r_F	slope resistance				6.5	m Ω
R_{thJC}	thermal resistance junction to case				0.55	K/W
R_{thCH}	thermal resistance case to heatsink			0.25		K/W
P_{tot}	total power dissipation		$T_C = 25^{\circ}C$		275	W
I_{FSM}	max. forward surge current	$t = 10 \text{ ms}; (50 \text{ Hz}), \text{ sine}; V_R = 0 V$	$T_{VJ} = 45^{\circ}C$		820	A
C_J	junction capacitance	$V_R = 24 V \quad f = 1 \text{ MHz}$	$T_{VJ} = 25^{\circ}C$		261	pF

Package TO-247			Ratings			
Symbol	Definition	Conditions	min.	typ.	max.	Unit
I_{RMS}	RMS current	per terminal ¹⁾			70	A
T_{VJ}	virtual junction temperature		-55		175	°C
T_{op}	operation temperature		-55		150	°C
T_{stg}	storage temperature		-55		150	°C
Weight				6		g
M_D	mounting torque		0.8		1.2	Nm
F_C	mounting force with clip		20		120	N

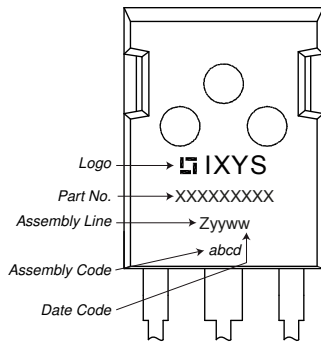
Product Marking

Part number

- D = Diode
- S = Schottky Diode
- A = low VF
- 90 = Current Rating [A]
- C = Common Cathode
- 200 = Reverse Voltage [V]
- HB = TO-247AD (3)

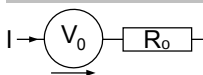
Ordering	Part Number	Marking on Product	Delivery Mode	Quantity	Code No.
Standard	DSA90C200HB	DSA90C200HB	Tube	30	502854

Equivalent Circuits for Simulation
** on die level*
 $T_{VJ} = 175\text{ °C}$

Schottky

$V_{0\max}$	threshold voltage	0.52	V
$R_{0\max}$	slope resistance *	3.9	mΩ

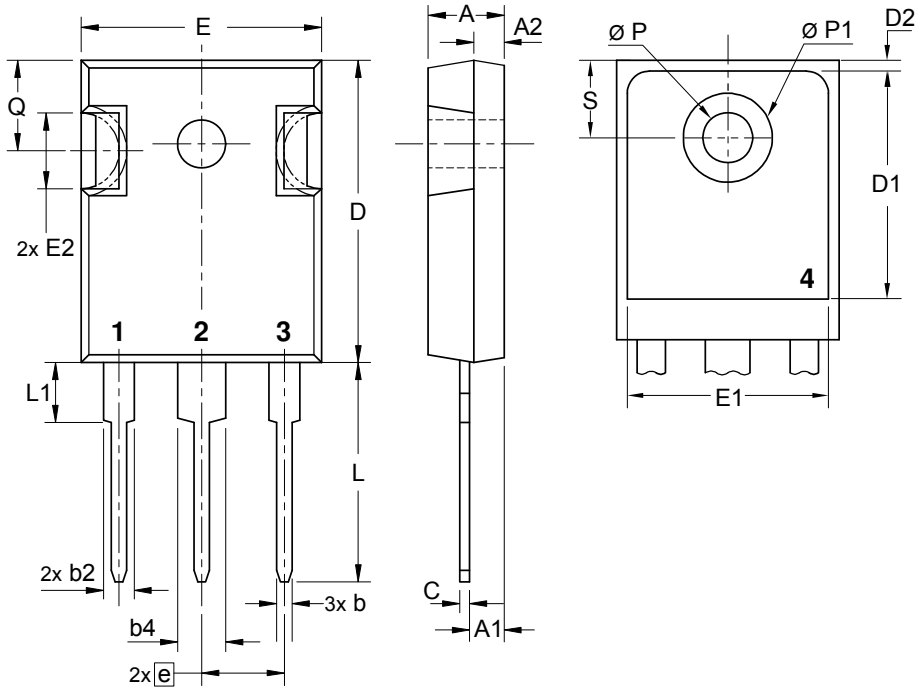
Outlines TO-247

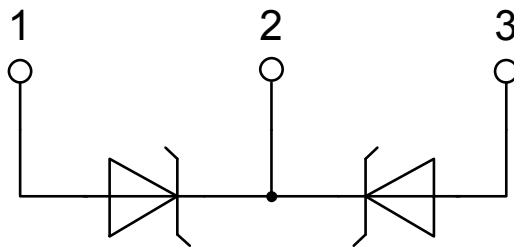

Sym.	Inches		Millimeter	
	min.	max.	min.	max.
A	0.185	0.209	4.70	5.30
A1	0.087	0.102	2.21	2.59
A2	0.059	0.098	1.50	2.49
D	0.819	0.845	20.79	21.45
E	0.610	0.640	15.48	16.24
E2	0.170	0.216	4.31	5.48
e	0.215 BSC		5.46 BSC	
L	0.780	0.800	19.80	20.30
L1	-	0.177	-	4.49
Ø P	0.140	0.144	3.55	3.65
Q	0.212	0.244	5.38	6.19
S	0.242 BSC		6.14 BSC	
b	0.039	0.055	0.99	1.40
b2	0.065	0.094	1.65	2.39
b4	0.102	0.135	2.59	3.43
c	0.015	0.035	0.38	0.89
D1	0.515	-	13.07	-
D2	0.020	0.053	0.51	1.35
E1	0.530	-	13.45	-
Ø P1	-	0.29	-	7.39



Schottky

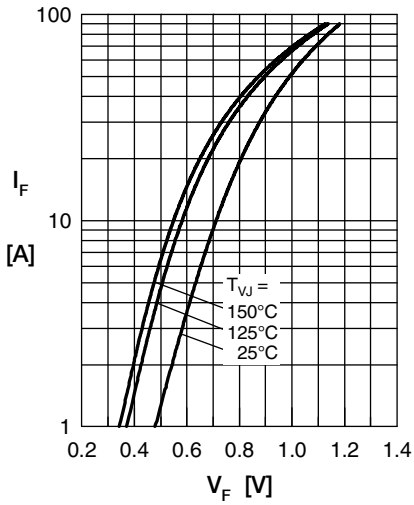

Fig. 1 Max. forward voltage drop characteristics

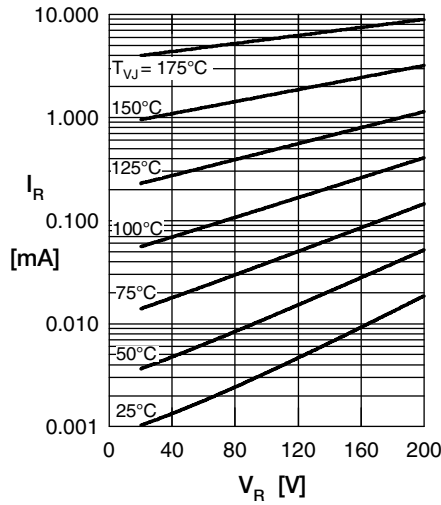

Fig. 2 Typ. reverse current I_R vs. rev. voltage V_R

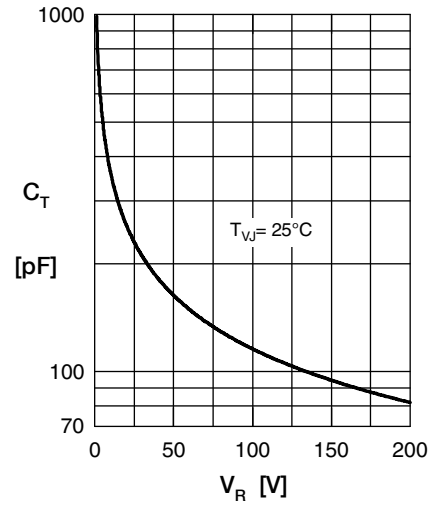

Fig. 3 Typ. junction capacitance C_T vs. reverse voltage V_R

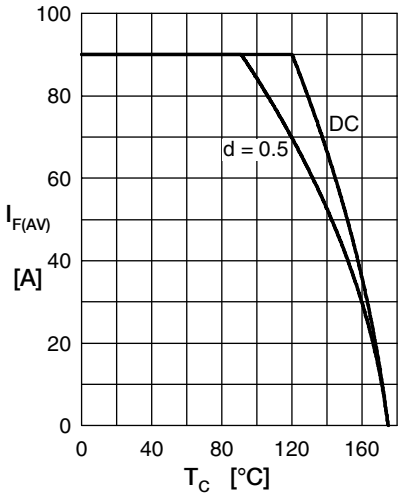

Fig. 4 Avg. forward current $I_{F(AV)}$ vs. case temp. T_C

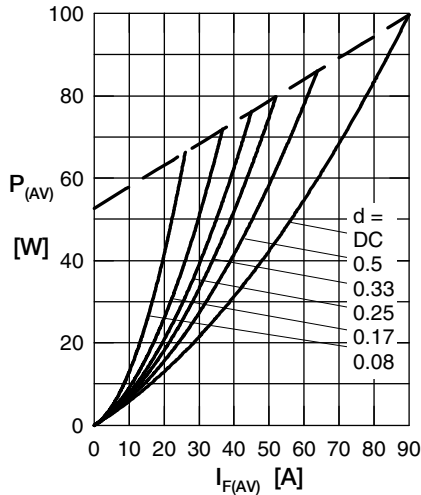

Fig. 5 Forward power loss characteristics

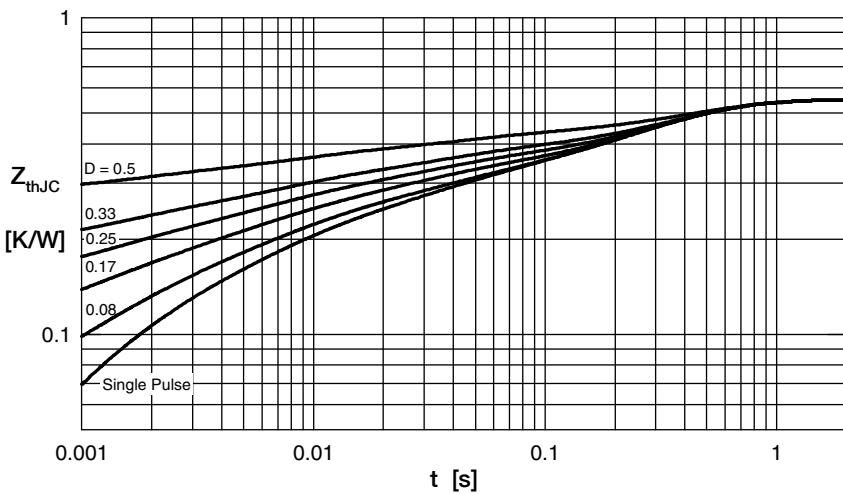

Fig. 6 Transient thermal impedance junction to case at various duty cycles