



Chipsmall Limited consists of a professional team with an average of over 10 year of expertise in the distribution of electronic components. Based in Hongkong, we have already established firm and mutual-benefit business relationships with customers from,Europe,America and south Asia,supplying obsolete and hard-to-find components to meet their specific needs.

With the principle of "Quality Parts,Customers Priority,Honest Operation,and Considerate Service",our business mainly focus on the distribution of electronic components. Line cards we deal with include Microchip,ALPS,ROHM,Xilinx,Pulse,ON,Everlight and Freescale. Main products comprise IC,Modules,Potentiometer,IC Socket,Relay,Connector.Our parts cover such applications as commercial,industrial, and automotives areas.

We are looking forward to setting up business relationship with you and hope to provide you with the best service and solution. Let us make a better world for our industry!



Contact us

Tel: +86-755-8981 8866 Fax: +86-755-8427 6832

Email & Skype: info@chipsmall.com Web: www.chipsmall.com

Address: A1208, Overseas Decoration Building, #122 Zhenhua RD., Futian, Shenzhen, China



General Description

The DSC2010FE2-B0003 is a high performance LVCMOS oscillator utilizing Micrel's proven silicon MEMS technology to provide excellent jitter and stability while incorporating additional device functionality.

The DSC2010FE2-B0003 allows the user to easily modify the frequency and drive strength of the oscillator using pins.

The DSC2010FE2-B0003 has provision for up to four user-defined pre-programmed, pin-selectable output frequencies, and eight pin-selectable output drive levels to help reduce EMI.

Applications

- Consumer Electronics
- Storage Area Networks
 - SATA, SAS, Fibre Channel
- Passive Optical Networks
 - EPON, 10G-EPON, GPON, 10G-GPON
- Ethernet
 - 1G, 10GBASE-T/KR/LR/SR, and FCoE
- HD/SD/SDI Video & Surveillance
- PCI Express
- Automotive

Features

- Frequency and output formats:
 - LVCMOS
 - 125/155.52MHz
- Low RMS phase jitter: <1ps (typ)
- ± 25 ppm frequency stability
- -20°C to +70°C ext. commercial temperature range
- High supply noise rejection: -50dBc
- Pin-selectable configurations
 - 3-bit output drive strength
 - Up to 4 output frequency combinations
- Excellent shock & vibration immunity
 - Qualified to MIL-STD-883
- High reliability
 - 20x better MTF than quartz oscillators
- Supply range of 2.25 to 3.6V
- AEC-Q100 automotive qualified
- 14-pin 3.2mm x 2.5mm QFN package

Block Diagram

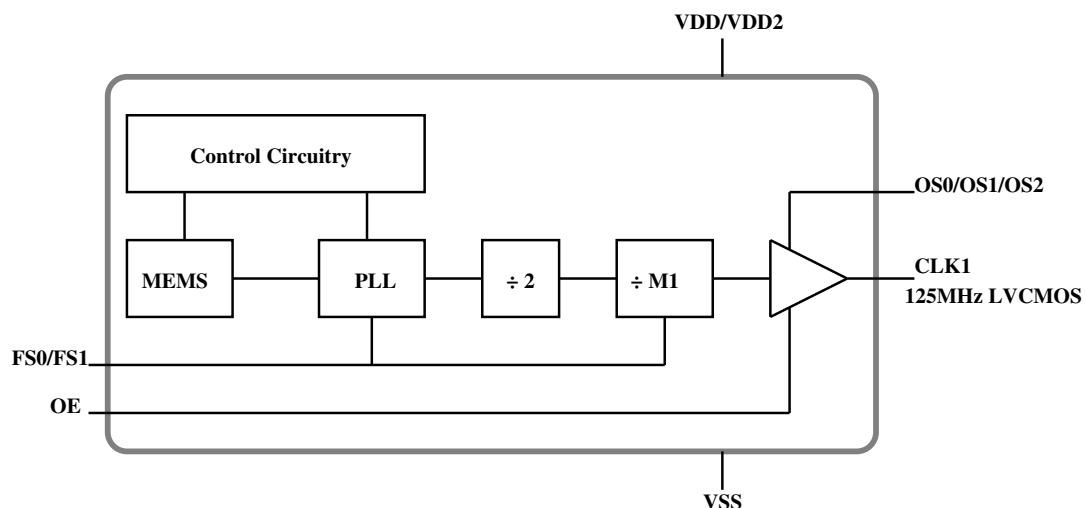

Ordering Information

Ordering Part Number	Industrial Temperature Range	Shipping	Package
DSC2010FE2-B0003	-20°C to +70°C	Tube	14-pin 3.2mm x 2.5mm QFN
DSC2010FE2-B0003T	-20°C to +70°C	Tape and Reel	14-pin 3.2mm x 2.5mm QFN

Devices are Green and RoHS compliant. Sample material may have only a partial top mark.

Pin Configuration

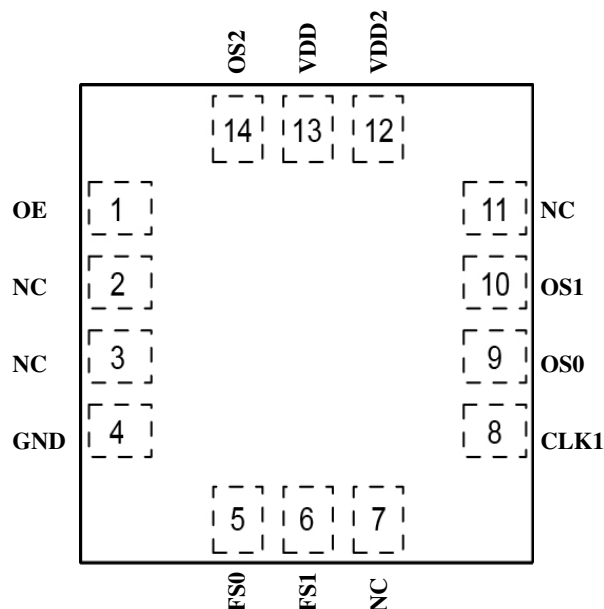

14-pin 3.2mm x 2.5mm QFN

Pin Description

Pin Number	Pin Name	Pin Type	Pin Function
1	OE	I	Enables outputs when high and disables outputs when low
2	NC		Leave unconnected or connect to ground
3	NC		Leave unconnected or connect to ground
4	GND	PWR	Ground
5	FS0	I	Least significant bit for frequency selection, see Table 2 for details
6	FS1	I	Most significant bit for frequency selection, see Table 2 for details
7	NC		Leave unconnected or connect to ground
8	CLK1	O	LVC MOS output
9	OS0	I	Least significant bit for output drive strength selection, see Table 1 for details
10	OS1	I	Middle bit for output drive strength selection, see Table 1 for details
11	NC		Leave unconnected or connect to ground
12, 13	VDD2, VDD	PWR	Power supply
14	OS2	I	Most significant bit for output drive strength selection, see Table 1 for details

Operational Description

The DSC2010FE2-B0003 is a LVCMOS oscillator consisting of a MEMS resonator and a supporting PLL IC. The LVCMOS output is generated through independent 8-bit programmable dividers from the output of the internal PLL.

The actual frequency output by DSC2010FE2-B0003 is controlled by an internal pre-programmed memory (OTP). This memory stores all coefficients required by the PLL for up to four different frequencies.

Two control pins (FS0, FS1) select the output frequency.

When OE (pin 1) is floated or connected to VDD, the DSC2010FE2-B0003 is in operational mode. Driving OE to ground will disable the output driver (high-impedance mode).

DSC2010FE2-B0003 has programmable output drive strength. Using three control pins (OS0-OS2) the drive strength can be adjusted to match circuit board impedances to reduce power supply noise, overshoot/undershoot and EMI. Table 1 displays typical rise / fall times for the output with a 15pF load capacitance as a function of these control pins at VDD = 3.3V and room temperature.

	Output Drive Strength Bits [OS2, OS1, OS0] - Default is [111]							
	000	001	010	011	100	101	110	111
tr (ns)	2.1	1.7	1.6	1.4	1.3	1.3	1.2	1.1
tf (ns)	2.5	2.4	2.4	2.2	1.8	1.6	1.4	1.4

Table 1. Rise/Fall Times for Drive Strengths

Output Clock Frequencies

Frequency select bits are weakly tied high so if left unconnected the default setting will be [11] and the device will output the associated frequency highlighted in bold.

Freq (MHz)	Freq Select Bits [FS1, FS0] - Default is [11]			
	00	01	10	11
CLK1	155.52	NA	NA	125

Table 2. Pin-Selectable Output Frequencies

Absolute Maximum Ratings

Item	Min.	Max.	Units	Condition
Supply Voltage	-0.3	+4.0	V	
Input Voltage	-0.3	VDD + 0.3	V	
Junction Temp	-	+150	°C	
Storage Temp	-55	+150	°C	
Soldering Temp	-	+260	°C	40sec max.
ESD				
HBM		4000	V	
MM		400		
CDM		1500		

1000+ years of data retention on internal memory

Specifications (Unless specified otherwise: T = 25°C, max LVC MOS drive strength)

Parameter	Symbol	Condition	Min.	Typ.	Max.	Units
Supply Voltage ¹	VDD		2.25		3.6	V
Supply Current	IDD	OE pin low - output is disabled		21	23	mA
Frequency Stability	ΔF	Includes frequency variation due to initial tolerance, temp. and power supply voltage			± 25	ppm
Aging	ΔF	First year (@ 25°C)			± 5	ppm
Startup Time ²	tSU	T = 25°C			5	ms
Input Logic Levels Input Logic High Input Logic Low	VIH VIL		0.75 x VDD -		- 0.25 x VDD	V
Output Disable Time ³	tDA				5	ns
Output Enable Time ³	tEN				20	ns
Pull-Up Resistor ⁴		Pull-up exists on all digital IO		40		kOhms
LVC MOS Output						
Supply Current ⁴	IDD	OE pin high - output is enabled CL = 15pF, F0 = 125MHz		31	35	mA
Output Logic Levels Output Logic High Output Logic Low	VOH VOL	I = ± 6 mA	0.9 x VDD -		- 0.1 x VDD	V
Output Transition Time ³ Rise Time Fall Time	tR tF	20% to 80% CL = 15pF		1.1 1.3	2 2	ns
Frequency	CLK1	[FS1, FS0] = [1, 1]		125		MHz
Output Duty Cycle	SYM		45		55	%
Period Jitter	JPER	F0 = 125MHz		3		psRMS
Integrated Phase Noise	JPH	200kHz to 20MHz @ 125MHz 100kHz to 20MHz @ 125MHz 12kHz to 20MHz @ 125MHz		0.3 0.38 1.7	2	psRMS

Notes:

- Pin 12 VDD2, and pin 13 VDD should be filtered with 0.1uF capacitors.
- tSU is time to 100ppm stable output frequency after VDD is applied and outputs are enabled.
- Output Waveform and Test Circuit figures below define the parameters.
- Output is enabled if OE pin is floated or not connected.

Nominal Performance Parameters (Unless specified otherwise: T = 25°C, VDD = 3.3V)

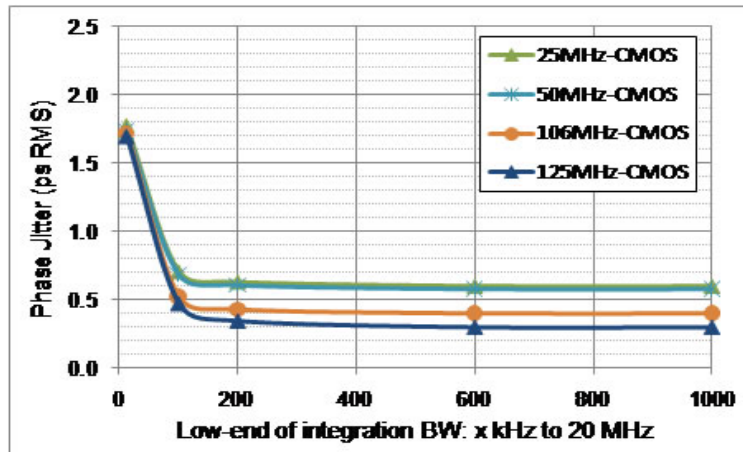

Figure 1. LVC MOS Phase Jitter (integrated phase noise)

LVC MOS Output Waveform

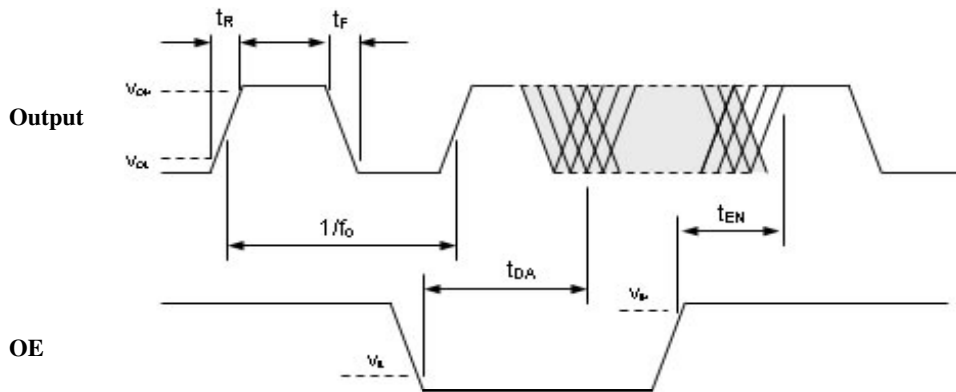

Figure 2. LVC MOS Output Waveform

MSL 1 @ 260°C refer to JSTD-020C	
Ramp-Up Rate (200°C to Peak Temp)	3°C/sec Max.
Preheat Time 150°C to 200°C	60 - 180 sec
Time maintained above 217°C	60 - 150 sec
Peak Temperature	255 - 260°C
Time within 5°C of actual Peak	20 - 40 sec
Ramp-Down Rate	6°C/sec Max.
Time 25°C to Peak Temperature	8 min Max.

Solder Reflow Profile

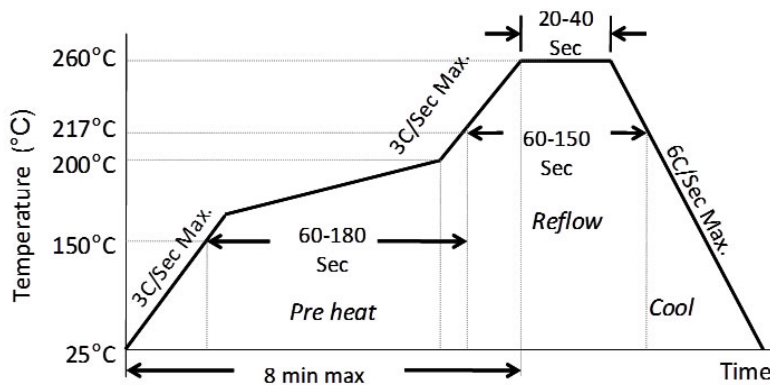
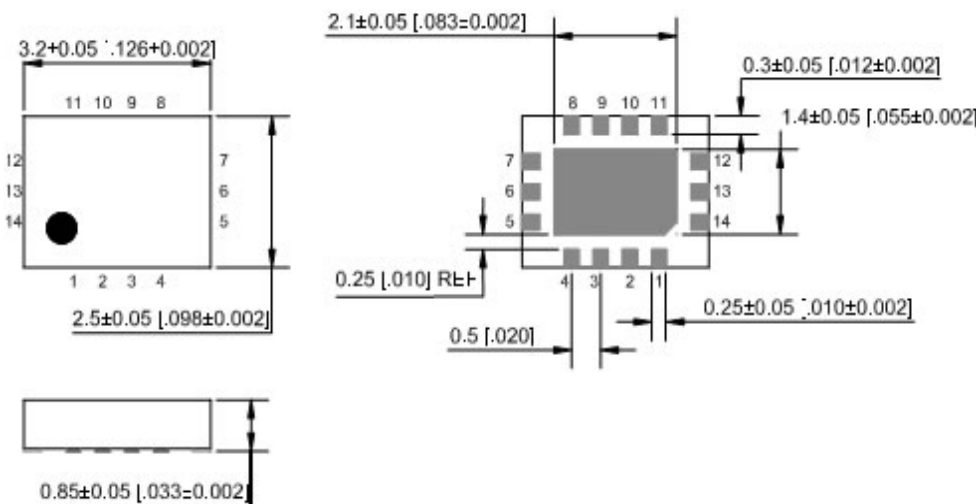

Figure 3. Solder Reflow Profile

Package Information⁶

External Dimensions

units: mm[inch]



Recommended Solder Pad Layout

units: mm[inch]

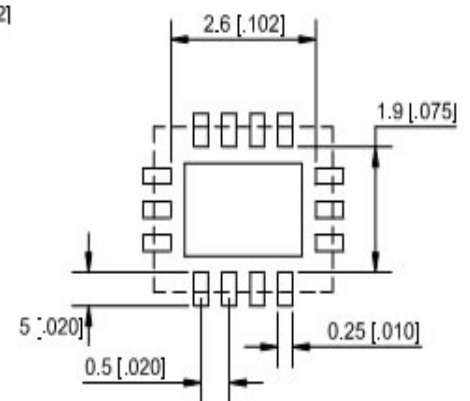

3.2mm x 2.5mm 14 Lead Plastic Package

Notes:

- 5. Connect the exposed die paddle to ground.
- 6. Package information is correct as of the publication date. For updates and most current information, go to www.micrel.com.

Micrel makes no representations or warranties with respect to the accuracy or completeness of the information furnished in this data sheet. This information is not intended as a warranty and Micrel does not assume responsibility for its use. Micrel reserves the right to change circuitry, specifications and descriptions at any time without notice. No license, whether express, implied, arising by estoppel or otherwise, to any intellectual property rights is granted by this document. Except as provided in Micrel's terms and conditions of sale for such products, Micrel assumes no liability whatsoever, and Micrel disclaims any express or implied warranty relating to the sale and/or use of Micrel products including liability or warranties relating to fitness for a particular purpose, merchantability, or infringement of any patent, copyright or other intellectual property right.

Micrel products are not designed or authorized for use as components in life support appliances, devices or systems where malfunction of a product can reasonably be expected to result in personal injury. Life support devices or systems are devices or systems that (a) are intended for surgical implant into the body or (b) support or sustain life, and whose failure to perform can be reasonably expected to result in a significant injury to the user. A Purchaser's use or sale of Micrel Products for use in life support appliances, devices or systems is a Purchaser's own risk and Purchaser agrees to fully indemnify Micrel for any damages resulting from such use or sale.

© 2014 Micrel, Incorporated.