



Chipsmall Limited consists of a professional team with an average of over 10 year of expertise in the distribution of electronic components. Based in Hongkong, we have already established firm and mutual-benefit business relationships with customers from,Europe,America and south Asia,supplying obsolete and hard-to-find components to meet their specific needs.

With the principle of “Quality Parts,Customers Priority,Honest Operation,and Considerate Service”,our business mainly focus on the distribution of electronic components. Line cards we deal with include Microchip,ALPS,ROHM,Xilinx,Pulse,ON,Everlight and Freescale. Main products comprise IC,Modules,Potentiometer,IC Socket,Relay,Connector.Our parts cover such applications as commercial,industrial, and automotives areas.

We are looking forward to setting up business relationship with you and hope to provide you with the best service and solution. Let us make a better world for our industry!



## Contact us

Tel: +86-755-8981 8866 Fax: +86-755-8427 6832

Email & Skype: info@chipsmall.com Web: www.chipsmall.com

Address: A1208, Overseas Decoration Building, #122 Zhenhua RD., Futian, Shenzhen, China



## General Description

The DSC2033FI1-F0025 is a programmable, high performance dual LVDS output oscillator utilizing Micrel's proven silicon MEMS technology to provide excellent jitter and stability while incorporating additional device functionality. Two LVDS outputs are controlled by separate supply voltages to allow for high output isolation. The frequencies of the outputs can be identical or independently derived from a common PLL frequency source.

The DSC2033FI1-F0025 has provision for up to eight user-defined pre-programmed, pin-selectable output frequency combinations.

## Applications

- Consumer Electronics
- Storage Area Networks
  - SATA, SAS, Fibre Channel
- Passive Optical Networks
  - EPON, 10G-EPON, GPON, 10G-GPON
- Ethernet
  - 1G, 10GBASE-T/KR/LR/SR, and FCoE
- HD/SD/SDI Video & Surveillance
- PCI Express
- Automotive

## Features

- Frequency and output formats:
  - LVDS 100/100MHz
  - LVDS 50/50MHz
- Low RMS phase jitter: <1ps (typ)
- ±50ppm frequency stability
- -40°C to +85°C industrial temperature range
- High supply noise rejection: -50dBc
- Pin-selectable configurations
  - Up to 8 output frequency combinations
- Excellent shock & vibration immunity
  - Qualified to MIL-STD-883
- High reliability
  - 20x better MTF than quartz oscillators
- Supply range of 2.25 to 3.6V
- AEC-Q100 automotive qualified
- 14-pin 3.2mm x 2.5mm QFN package

## Block Diagram

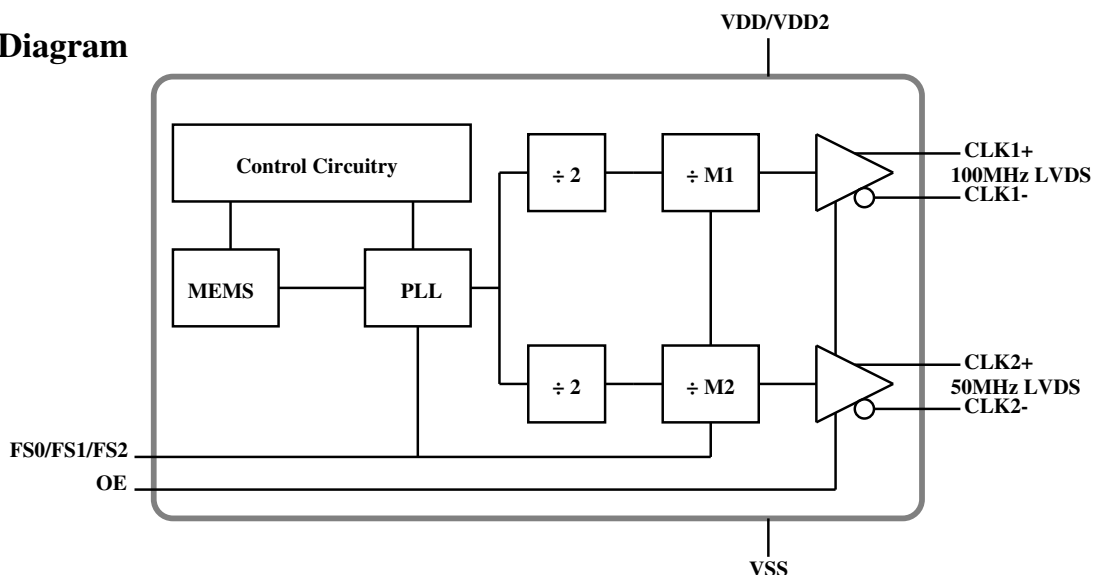

## Ordering Information

Ordering Part Number	Industrial Temperature Range	Shipping	Package
DSC2033FI1-F0025	-40°C to +85°C	Tube	14-pin 3.2mm x 2.5mm QFN
DSC2033FI1-F0025T	-40°C to +85°C	Tape and Reel	14-pin 3.2mm x 2.5mm QFN

Devices are Green and RoHS compliant. Sample material may have only a partial top mark.

## Pin Configuration

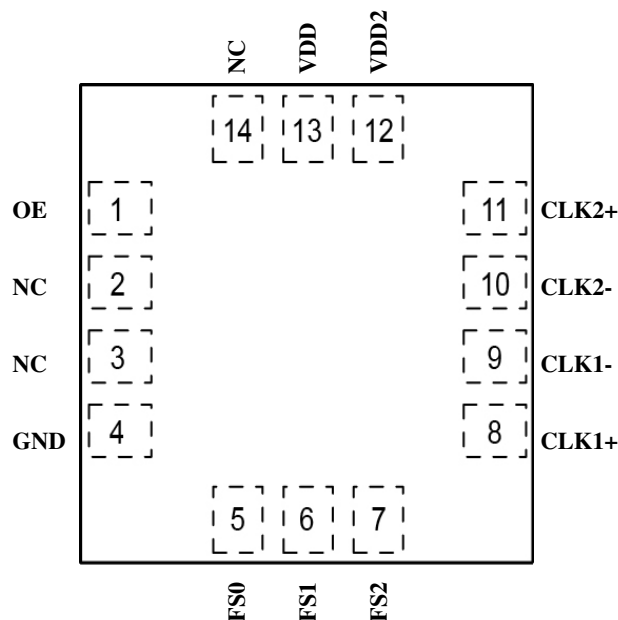

14-pin 3.2mm x 2.5mm QFN

## Pin Description

Pin Number	Pin Name	Pin Type	Pin Function
1	OE	I	Enables outputs when high and disables outputs when low
2	NC		Leave unconnected or connect to ground
3	NC		Leave unconnected or connect to ground
4	GND	PWR	Ground
5	FS0	I	Least significant bit for frequency selection, see Table 1 for details
6	FS1	I	Middle bit for frequency selection, see Table 1 for details
7	FS2	I	Most significant bit for frequency selection, see Table 1 for details
8	CLK1+	O	Positive LVDS output
9	CLK1-	O	Negative LVDS output
10	CLK2-	O	Negative LVDS output
11	CLK2+	O	Positive LVDS output
12	VDD2	PWR	Power supply for LVDS output CLK2, 1.65V to 3.6V (VDD2 ≤ VDD)
13	VDD	PWR	Power supply
14	NC		Leave unconnected or connect to ground

## Operational Description

The DSC2033FI1-F0025 is a dual output LVDS oscillator consisting of a MEMS resonator and a supporting PLL IC. The two LVDS outputs are generated through independent 8-bit programmable dividers from the output of the internal PLL. The two constraints are imposed on the output frequencies: 1)  $f_2 = M \times f_1/N$ , where M and N are even integers between 4 and 254, 2)  $1.2\text{GHz} < N \times f_2 < 1.7\text{GHz}$ . The actual frequencies output by DSC2033FI1-F0025 are controlled by an internal pre-programmed memory (OTP). This memory stores all coefficients required by the PLL for up to eight different frequency combinations. Three control pins (FS0 - FS2) select the output frequency combination.

When OE (pin 1) is floated or connected to VDD, the DSC2033 is in operational mode. Driving OE to ground will tri-state both output drivers (high-impedance mode).

## Output Clock Frequencies

Frequency select bits are weakly tied high so if left unconnected the default setting will be [111] and the device will output the associated frequency highlighted in bold.

Freq (MHz)	Freq Select Bits [FS2, FS1, FS0] - Default is [111]							
	000	001	010	011	100	101	110	<b>111</b>
CLK1	100	NA	NA	NA	NA	NA	NA	<b>100</b>
CLK2	50	NA	NA	NA	NA	NA	NA	<b>50</b>

Table 1. Pin-Selectable Output Frequencies

## Absolute Maximum Ratings

Item	Min.	Max.	Units	Condition
Supply Voltage	-0.3	+4.0	V	
Input Voltage	-0.3	VDD + 0.3	V	
Junction Temp	-	+150	°C	
Storage Temp	-55	+150	°C	
Soldering Temp	-	+260	°C	40sec max.
ESD				
HBM		4000	V	
MM		400		
CDM		1500		

1000+ years of data retention on internal memory



**Specifications** (Unless specified otherwise: T = 25°C)

Parameter	Symbol	Condition	Min.	Typ.	Max.	Units
Supply Voltage <sup>1</sup>	VDD		2.25		3.6	V
Supply Current	IDD	OE pin low - output is disabled		21	23	mA
Supply Current <sup>2</sup>	IDD	OE pin high - outputs are enabled RL = 50Ohms, F01 = F02 = 156.25MHz		38		mA
Frequency Stability	$\Delta F$	Includes frequency variation due to initial tolerance, temp. and power supply voltage			$\pm 50$	ppm
Aging	$\Delta F$	First year (@ 25°C)			$\pm 5$	ppm
Startup Time <sup>3</sup>	tSU	T = 25°C			5	ms
Input Logic Levels Input Logic High Input Logic Low	VIH VIL		0.75 x VDD -		- 0.25 x VDD	V
Output Disable Time <sup>4</sup>	tDA				5	ns
Output Enable Time	tEN				20	ns
Pull-Up Resistor <sup>2</sup>		Pull-up exists on all digital IO		40		kOhms
<b>LVDS Outputs</b>						
Output Offset Voltage		RL = 100Ohms Differential	1.125		1.4	V
Delta Offset Voltage					50	mV
Pk to Pk Output Swing		Single-Ended		350		mV
Output Transition Time <sup>4</sup> Rise Time Fall Time	tR tF	20% to 80% RL = 50Ohms, CL = 2pF (to GND)		200	350	ps
Frequency	CLK1 CLK2	[FS2, FS1, FS0] = [1, 1, 1]		100 50		MHz
Output Duty Cycle	SYM	Differential	48		52	%
Period Jitter <sup>5</sup>	JPER	F01 = F02 = 156.25MHz		2.5		psRMS
Integrated Phase Noise	JPH	200kHz to 20MHz @ 156.25MHz 100kHz to 20MHz @ 156.25MHz 12kHz to 20MHz @ 156.25MHz		0.28 0.4 1.7	2	psRMS

**Notes:**

- Pin 12 VDD2, and pin 13 VDD should be filtered with 0.1uF capacitors.
- Output is enabled if OE pin is floated or not connected.
- tSU is time to 100ppm stable output frequency after VDD is applied and outputs are enabled.
- Output Waveform and Test Circuit figures below define the parameters.
- Period Jitter includes crosstalk from adjacent output.

**Nominal Performance Parameters** (Unless specified otherwise: T = 25°C, VDD = 3.3V)

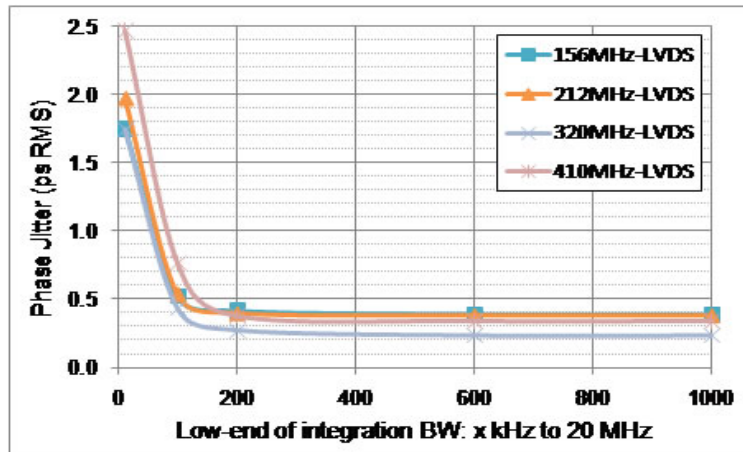

Figure 1. LVDS Phase Jitter (integrated phase noise)

**LVDS Output Waveform**

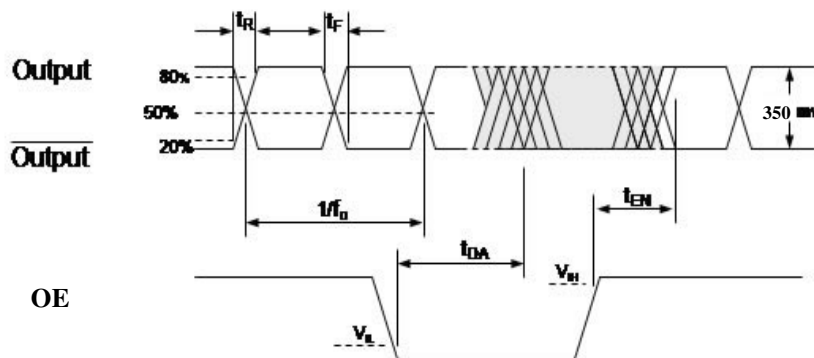

Figure 2. LVDS Output Waveform

MSL 1 @ 260°C refer to JSTD-020C	
Ramp-Up Rate (200°C to Peak Temp)	3°C/sec Max.
Preheat Time 150°C to 200°C	60 - 180 sec
Time maintained above 217°C	60 - 150 sec
Peak Temperature	255 - 260°C
Time within 5°C of actual Peak	20 - 40 sec
Ramp-Down Rate	6°C/sec Max.
Time 25°C to Peak Temperature	8 min Max.

## Solder Reflow Profile

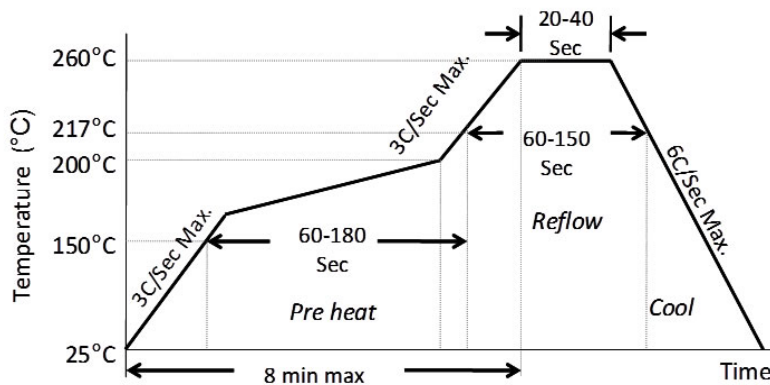
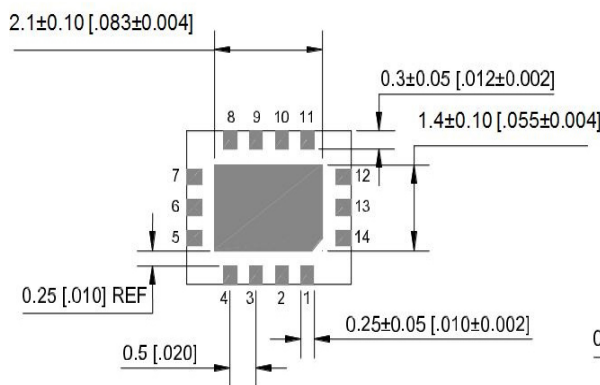
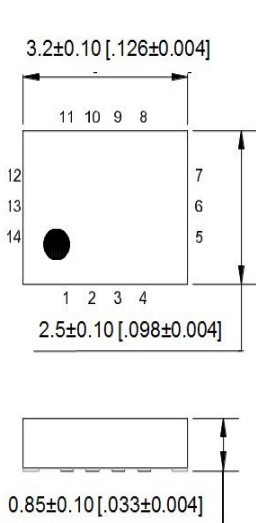

Figure 3. Solder Reflow Profile

## Package Information<sup>7</sup>

### External Dimensions

units: mm[inch]



### Recommended Solder Pad Layout

units: mm[inch]

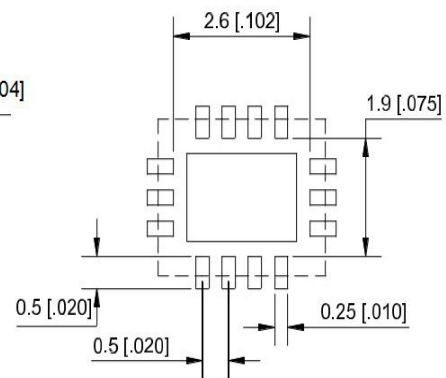

### 3.2mm x 2.5mm 14 Lead Plastic Package

**Notes:**

- 6. Connect the exposed die paddle to ground.
- 7. Package information is correct as of the publication date. For updates and most current information, go to [www.micrel.com](http://www.micrel.com).

Micrel makes no representations or warranties with respect to the accuracy or completeness of the information furnished in this data sheet. This information is not intended as a warranty and Micrel does not assume responsibility for its use. Micrel reserves the right to change circuitry, specifications and descriptions at any time without notice. No license, whether express, implied, arising by estoppel or otherwise, to any intellectual property rights is granted by this document. Except as provided in Micrel's terms and conditions of sale for such products, Micrel assumes no liability whatsoever, and Micrel disclaims any express or implied warranty relating to the sale and/or use of Micrel products including liability or warranties relating to fitness for a particular purpose, merchantability, or infringement of any patent, copyright or other intellectual property right.

Micrel products are not designed or authorized for use as components in life support appliances, devices or systems where malfunction of a product can reasonably be expected to result in personal injury. Life support devices or systems are devices or systems that (a) are intended for surgical implant into the body or (b) support or sustain life, and whose failure to perform can be reasonably expected to result in a significant injury to the user. A Purchaser's use or sale of Micrel Products for use in life support appliances, devices or systems is a Purchaser's own risk and Purchaser agrees to fully indemnify Micrel for any damages resulting from such use or sale.

© 2015 Micrel, Incorporated.