



Chipsmall Limited consists of a professional team with an average of over 10 year of expertise in the distribution of electronic components. Based in Hongkong, we have already established firm and mutual-benefit business relationships with customers from,Europe,America and south Asia,supplying obsolete and hard-to-find components to meet their specific needs.

With the principle of “Quality Parts,Customers Priority,Honest Operation,and Considerate Service”,our business mainly focus on the distribution of electronic components. Line cards we deal with include Microchip,ALPS,ROHM,Xilinx,Pulse,ON,Everlight and Freescale. Main products comprise IC,Modules,Potentiometer,IC Socket,Relay,Connector.Our parts cover such applications as commercial,industrial, and automotives areas.

We are looking forward to setting up business relationship with you and hope to provide you with the best service and solution. Let us make a better world for our industry!



## Contact us

Tel: +86-755-8981 8866 Fax: +86-755-8427 6832

Email & Skype: info@chipsmall.com Web: www.chipsmall.com

Address: A1208, Overseas Decoration Building, #122 Zhenhua RD., Futian, Shenzhen, China





# DSM7T Series

## Thin Surface Mount Single Digit 7-Segment LED Numeric Display

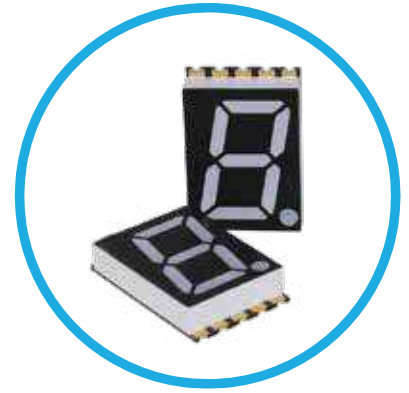

DSM7TA28106T - 0.28" (7.11mm) Digit Height  
Emitting Color: Blue (InGaN)

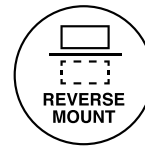
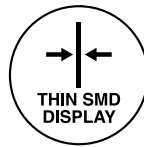

DSM7TA28106T

### Application

- People Movers
- Home Appliances
- Medical Devices
- Industrial Devices
- Automation and Controls
- Light Control
- IoT
- Transportation
- Food Service Appliances

### Key features

- 1-digit seven segment led numeric display
- Includes a decimal point (DP), useful when two or more seven-segment displays are connected to each other to display decimals
- White segments and grey surface
- Substrate: InGaN
- Outer dimensions: 12.0 x 7.40 x 4.00mm
- High light output
- Excellent character appearance
- Quality tested with the highest industry standard
- Side by side mounting allows space saving
- Provides the ability to reduce overall thickness of PCB, with major cost savings
- Available in 3 different digit heights and widths
- Automation-friendly tape and reel
- Technically and mechanically rugged
- Small and light, easy assembly
- Life expectancy: up to 50,000 hours
- Lower power consumption
- Allow top mount and reverse mount design
- Mechanically rugged
- Moisture Sensitive Level (MSL): 2a
- Available in blue, red and pure green
- Polarity: common anode
- Easy mounting on PC boards or sockets
- Low current operation
- Degree of protection IP50 (Dust-Protected)

# Ordering Data

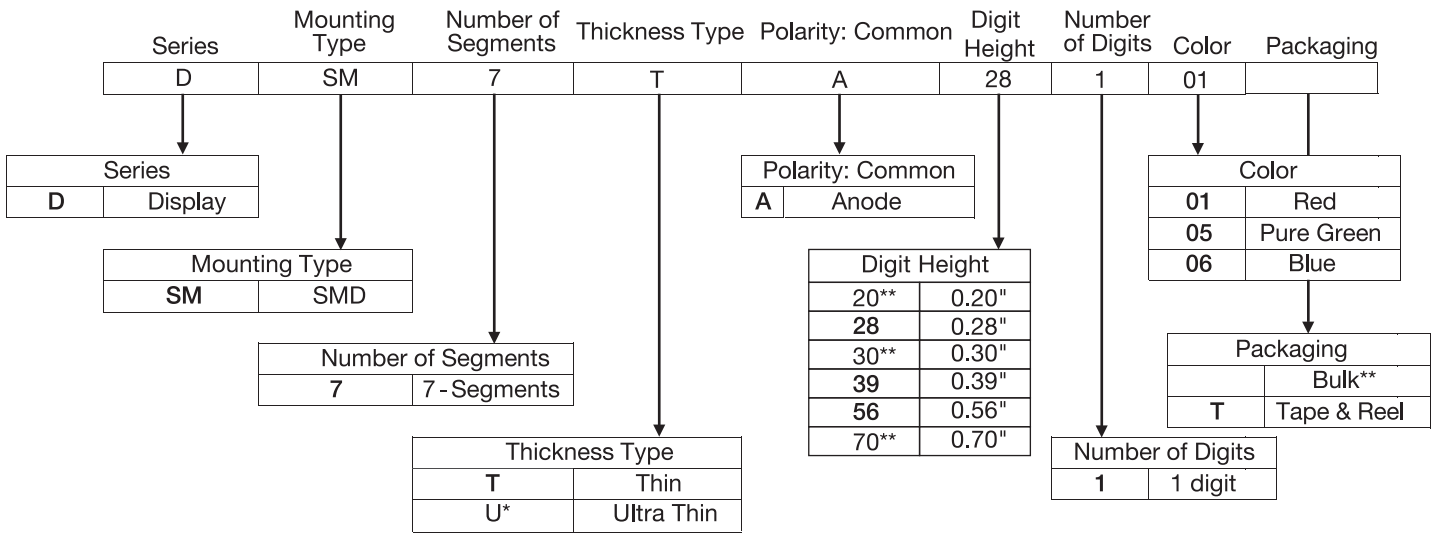

\*Please refer to DSM7U product datasheet for Ultra Thin Version  
 \*\*Only available for DSM7U Version

# Dimensions and Internal Circuit Diagram

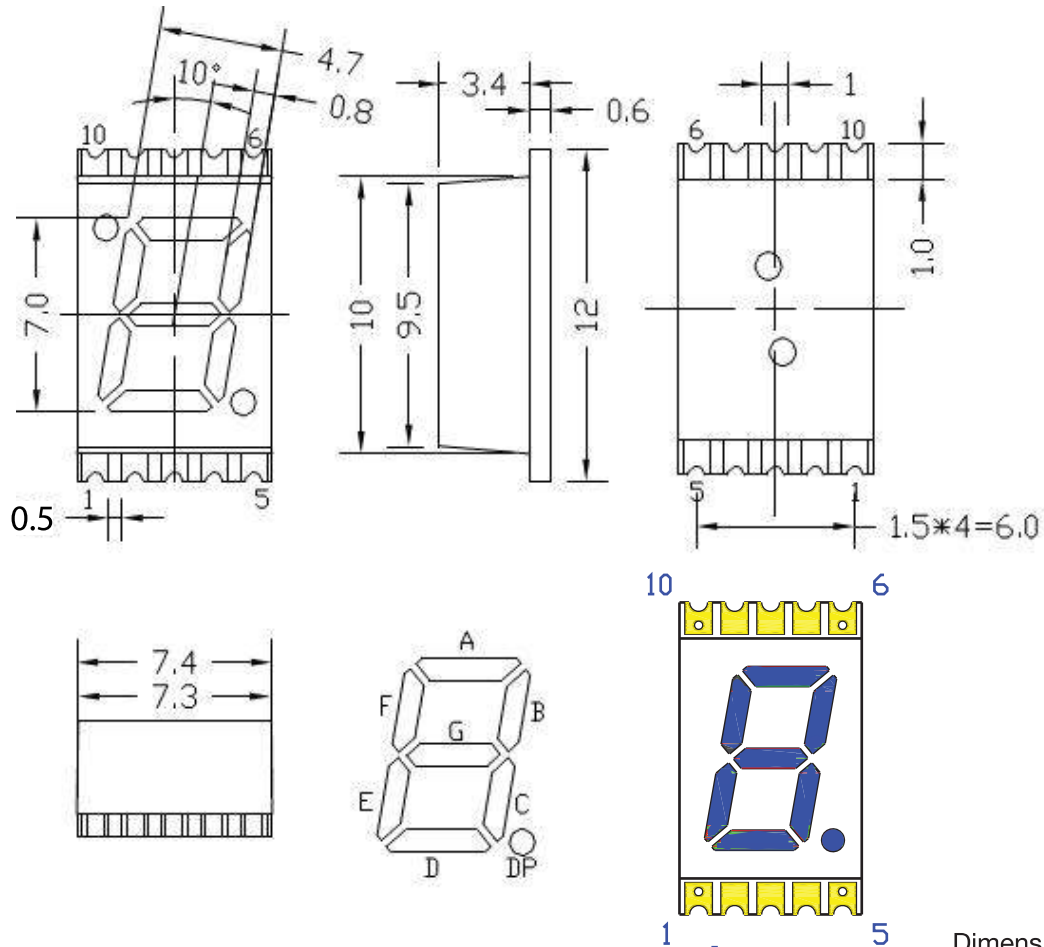

Dimensions in millimeters  
 Tolerance is ±0.25mm unless otherwise noted



## Internal Circuit Diagram

### Pin Connections (Common Anode)

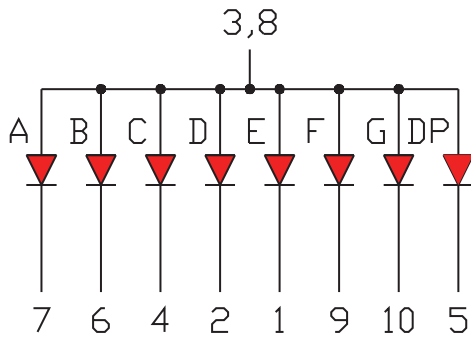

PIN No	Connection
1	CATHODE E
2	CATHODE D
3	COMMON ANODE
4	CATHODE C
5	CATHODE DP
6	CATHODE B
7	CATHODE A
8	COMMON ANODE
9	CATHODE F
10	CATHODE G

## Product Specifications

### Absolute Maximum Ratings while Ta=25°C

Parameter	Minimum (m)	Maximum (M)	Unit
Forward Current $I_F$ /Seg	--	20	mA
Reverse Voltage $V_R$ /Seg	--	5	V
Operating Temperature $T_{OPR}$	-30	+85	°C
Storage Temperature $T_{STG}$	-40	+100	°C
Peak Current $I_{FM}$ /Seg	--	60	mA

(Notice: 1/10th duty cycle, 0.1ms pulse width)

### Electrical-Optical Characteristics while Ta=25°C

Parameter	Condition	Unit	Minimum	Typical	Maximum
Forward Voltage $V_F$ /Seg	IF=20mA	V	2.6	3.1	3.6
Reverse Current $I_R$ /Seg	VR=5V	μA	--	--	50
Wavelength $\lambda_P$	IF=20mA	nm	455	460	465
Full Width at Half Maximum $\Delta\lambda$	IF=20mA	nm	--	15	--
Luminosity $I_V$ /Seg	IF=20mA	mcd	150	210	305
Viewing angle	wide viewing angle				

# Product Specifications

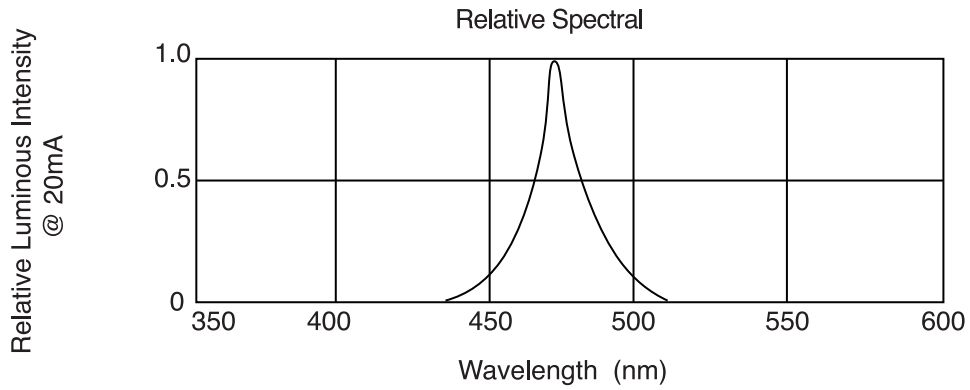

**Forward Current vs. Forward Voltage**

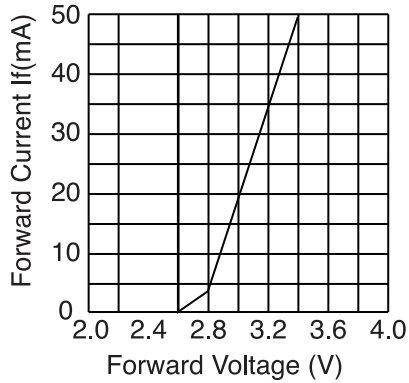

**Relative Luminous Intensity vs. Forward current**

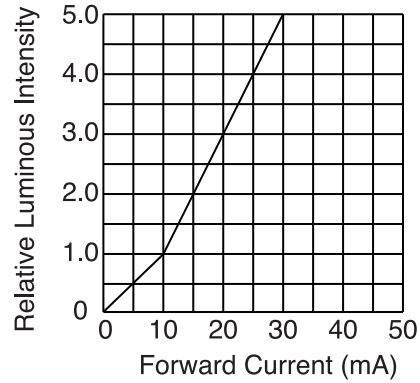

**Forward Current Vs. Temperature**

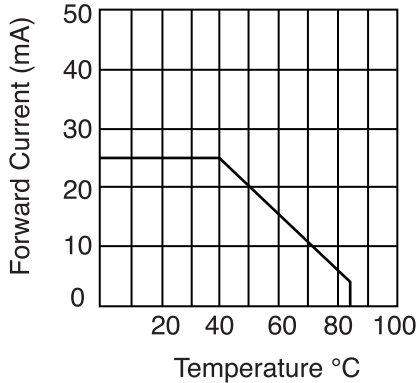

**Luminous Intensity vs. Temperature**

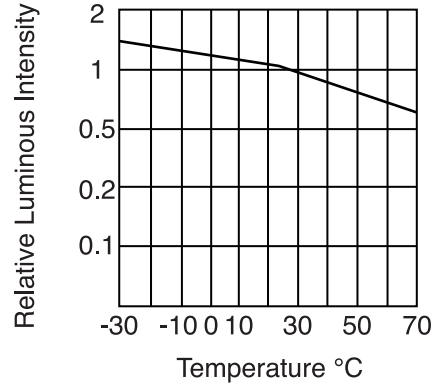

## Circuit Design Notes

- Always use current limit resistors when necessary
- LEDs could be electrically connected in parallel, with each current limiting resistor

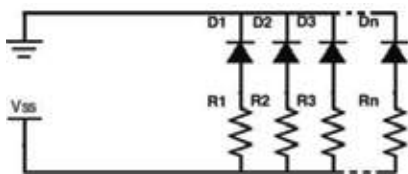

Correct

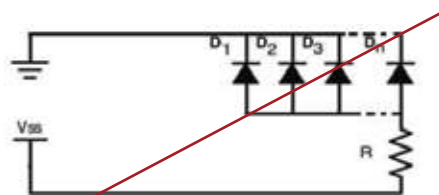

**INCORRECT**

# Recommended Reflow Soldering Profile

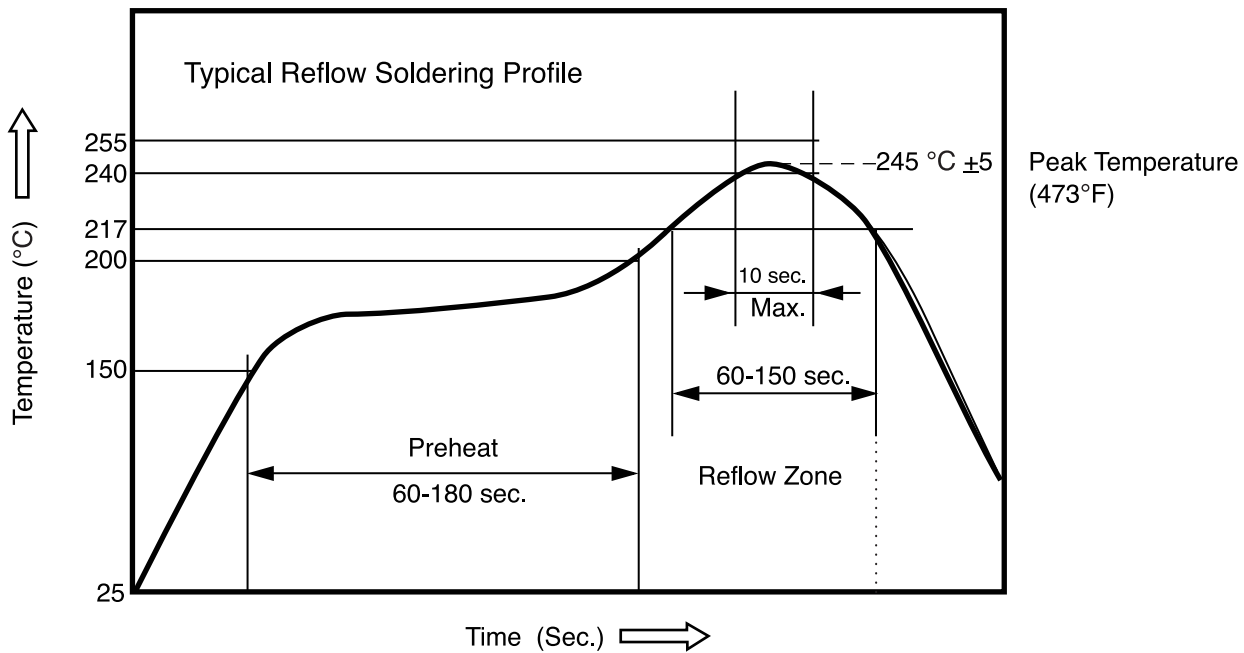

Profile Feature	Typical Parameters
Preheat Temperature Min	150 °C (302°F)
Preheat Temperature Max	200 °C (392°F)
Preheat Time	60 -180 sec.
Reflow Starting Temperature	217 °C (423°F)
Time Spent During Reflow	60 -150 sec.
Reflow Peak Temperature	245 °C (473°F)

- Manual soldering is suggested
  - Use soldering irons of which power is less than 30 Watt.
  - Keep the temperature of soldering irons below 360 °C
  - Only one soldering is allowed on each bonding pad.
  - The maximum time from when a soldering iron comes into contact with the parts that are to be connected until the joint is finished should not exceed three seconds.
  - Perform other procedures after the soldered pad cools down.
- Suggested storage conditions: 25°C +/-10°C (77°F +/-50°F), relative humidity 65% RH +/- 20% RH.

# Tape and Reel Dimensions

Carrier band

Electrostatic Discharge (ESD) Package  
Anti Static Bags Aluminium Moisture Barrier Bag.

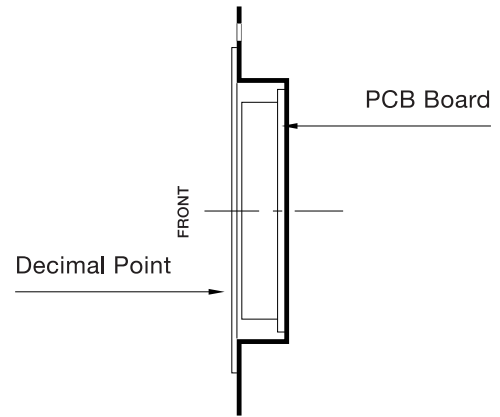
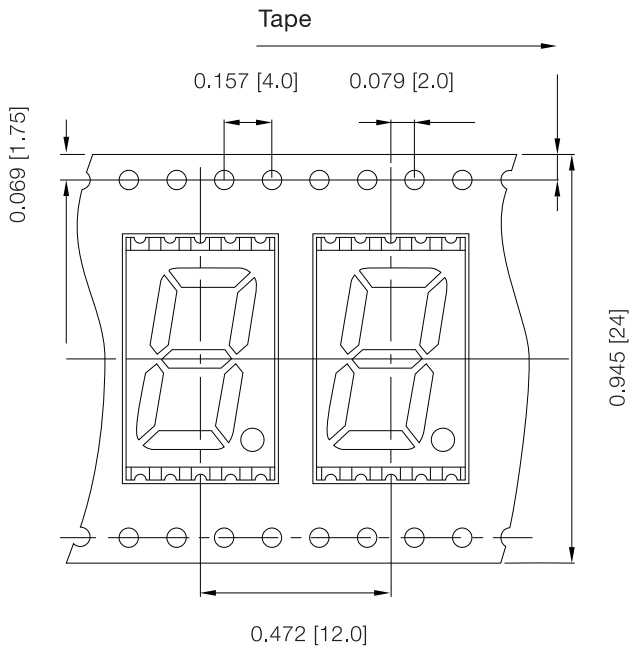

## Reel Dimensions

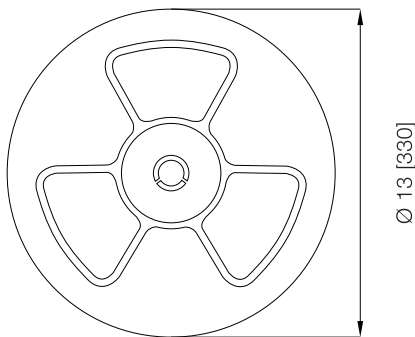

1300PCS/Reel

Direction of the feed

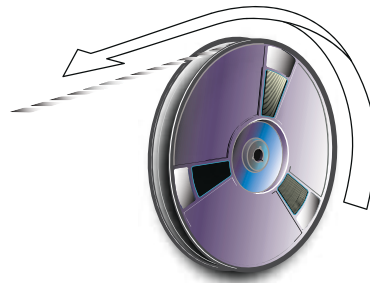

Allow top mount or reverse mount design

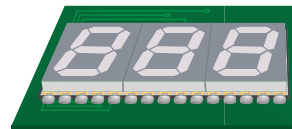

Top Mount



Reverse Mount

Dimensions in inches [millimeters]

## Compliances and Approvals

