



Chipsmall Limited consists of a professional team with an average of over 10 year of expertise in the distribution of electronic components. Based in Hongkong, we have already established firm and mutual-benefit business relationships with customers from,Europe,America and south Asia,supplying obsolete and hard-to-find components to meet their specific needs.

With the principle of “Quality Parts,Customers Priority,Honest Operation,and Considerate Service”,our business mainly focus on the distribution of electronic components. Line cards we deal with include Microchip,ALPS,ROHM,Xilinx,Pulse,ON,Everlight and Freescale. Main products comprise IC,Modules,Potentiometer,IC Socket,Relay,Connector.Our parts cover such applications as commercial,industrial, and automotives areas.

We are looking forward to setting up business relationship with you and hope to provide you with the best service and solution. Let us make a better world for our industry!



## Contact us

Tel: +86-755-8981 8866 Fax: +86-755-8427 6832

Email & Skype: info@chipsmall.com Web: www.chipsmall.com

Address: A1208, Overseas Decoration Building, #122 Zhenhua RD., Futian, Shenzhen, China



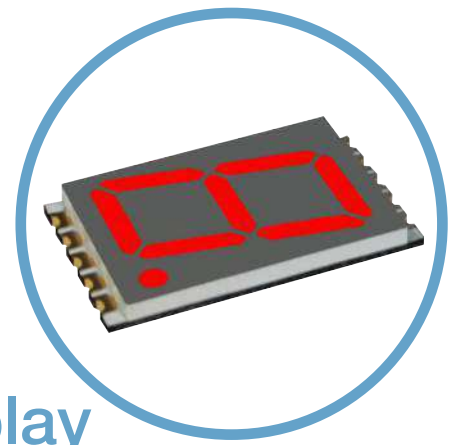

# DSM Series Ultra Thin Surface Mount Single Digit 7-Segment LED Display

DSM7UA56101 - 0.56" (14.22mm) Digit Height  
Emitting Color: Red (AlGaInP/GaAs)

## Applications

- People Movers
- Home Appliances
- Medical Devices
- Industrial Devices
- Automation and Controls
- Light Control
- IoT
- Transportation
- Food Service Appliances

## Key Features

- 1-digit seven segment led numeric display
- Outer dimensions: 20.0 x 12.50 x 2.1mm
- Reduce overall thickness of PCB, with major cost savings
- Available in 4 different digit heights and widths
- Excellent character appearance, with high light output
- Super bright red chip
- Made from AlGaInP on transparent GaAs substrate
- Made of white segments and gray surface
- Also available in pure green
- Available in cut tape or automation-friendly tape and reel
- Exclusive patented technology
- Low current operation and lower power consumption
- Polarity: common anode
- Available for reverse mounting configuration
- Side by side mounting allows space saving
- Easy mounting on PC boards or sockets
- Moisture Sensitive Level (MSL): 2a
- Life expectancy: 100,000 hours
- Technically and mechanically rugged
- Quality tested with the highest industry standard

## Ordering Data

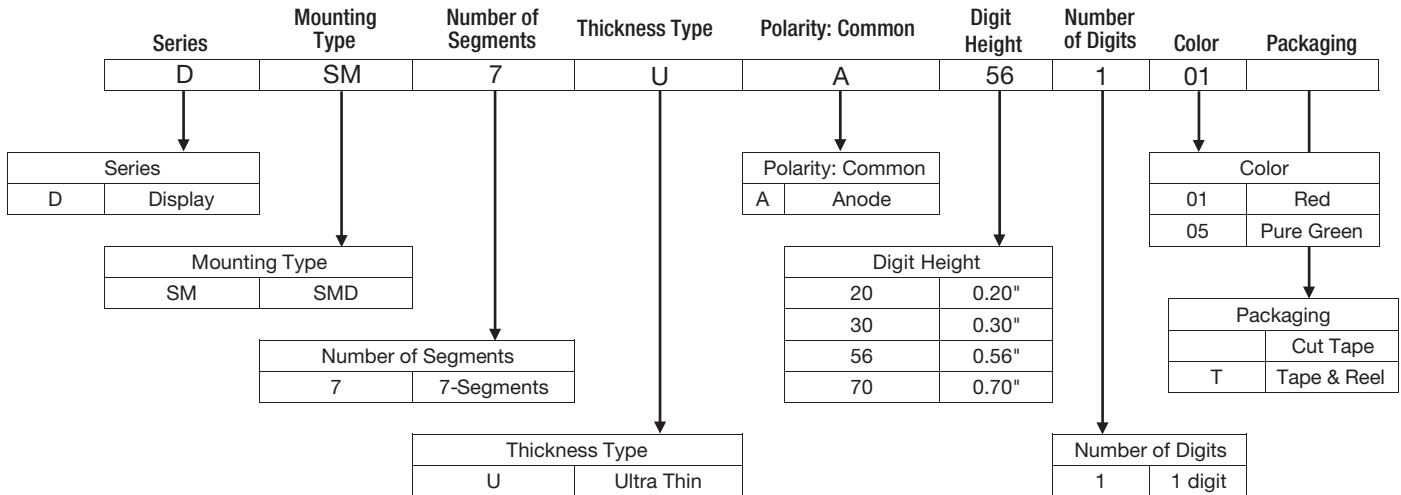

## Dimensions and Internal Circuit Diagram

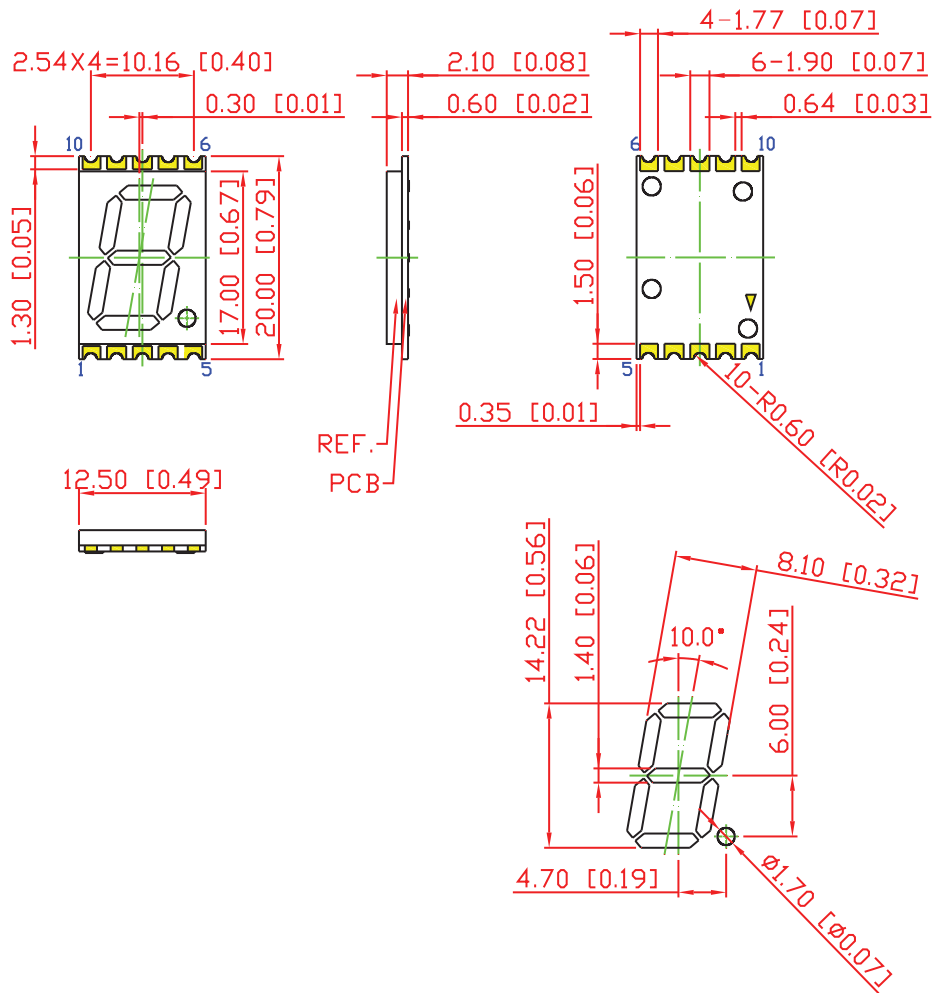

Dimensions in millimeters [inches]  
Tolerance is  $\pm 0.25\text{mm}$  [0.01"] unless otherwise noted

# Dimensions and Internal Circuit Diagram

## Recommended Reverse Mount Solder Pattern

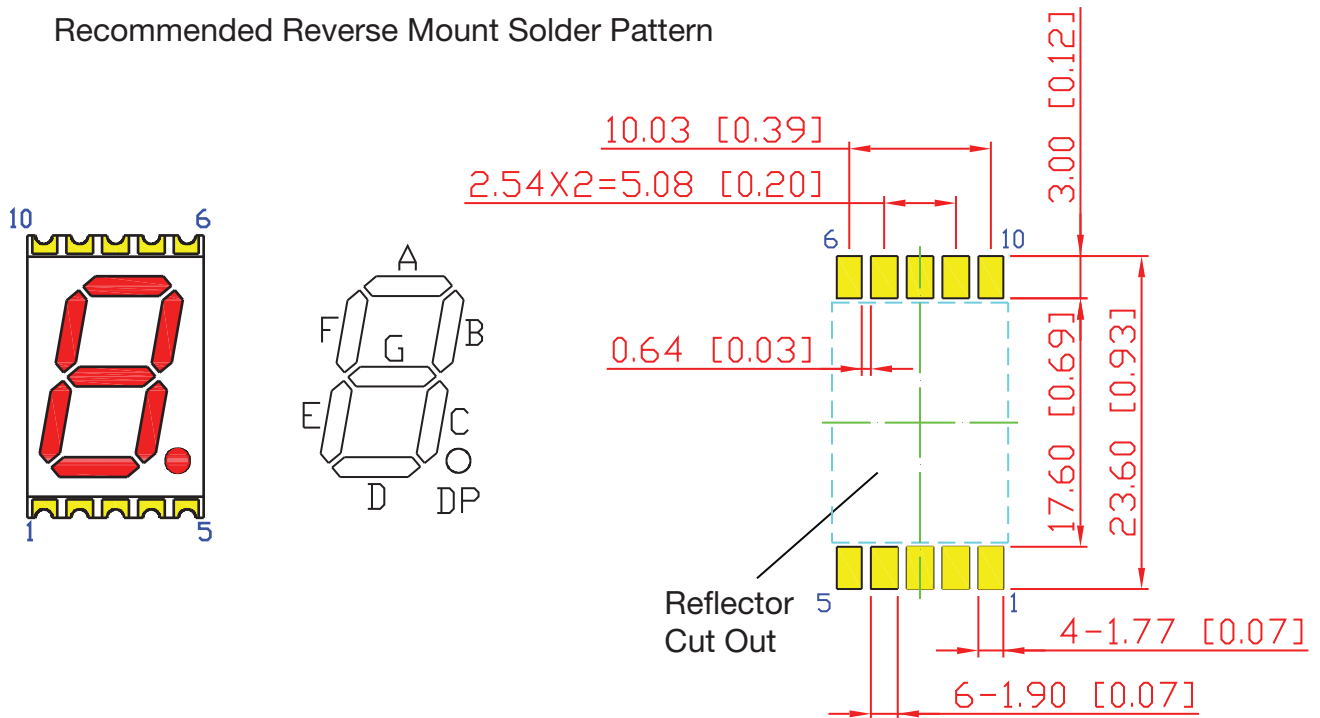

Dimensions in millimeters [inches]

Tolerance is  $\pm 0.25\text{mm}$  [0.01"] unless otherwise noted

## Pin Connections (Common Anode)

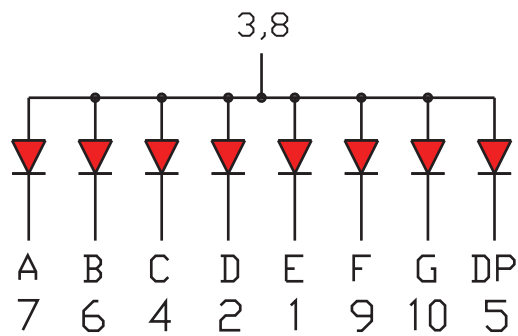

PIN No	Connection
1	CATHODE E
2	CATHODE D
3	COMMON ANODE
4	CATHODE C
5	CATHODE DP
6	CATHODE B
7	CATHODE A
8	COMMON ANODE
9	CATHODE F
10	CATHODE G



## Product Specifications

### Absolute Maximum Rating at Ta=25°C / 77°F (Ta= Ambient Temperature)

Parameter	Symbol	Maximum Rating	Unit
Power dissipation	P <sub>AD</sub>	70	mW
Derating liner from 25°C/77°F	-	0.28/9.46	mA °C / °F
Continuous forward current	I <sub>AF</sub>	25	mA
Peak current (duty cycle 1/10, 1kHz)	I <sub>PF</sub>	90	mA
Reverse voltage	V <sub>R</sub>	5	V
Operating temperature	T <sub>OPR</sub>	-40 TO +105 -40 TO +221	°C °F
Storage temperature	T <sub>STG</sub>	-40 TO +105 -40 TO +221	°C °F

### Electrical - Optical Characteristics at Ta=25°C / 77°F (Ta= Ambient Temperature)

Charateristic	Symbol	Condition	Min.	Typ.	Max.	Unit
Forward Voltage, (Per Dice)	V <sub>F</sub>	I <sub>F</sub> =20mA	-	2.0	2.6	V
Reverse Current, (Per Dice)	I <sub>R</sub>	V <sub>R</sub> =5V	-	-	10	μA
Peak Wavelength	λ <sub>P</sub>	I <sub>F</sub> =20mA	-	632	-	nm
Dominant Wavelength	λ <sub>D</sub>	I <sub>F</sub> =20mA	619	-	629	nm
Luminous Intensity	I <sub>V</sub>	I <sub>F</sub> =20mA	10	-	40	mcd
Spectral radiation bandwidth	Δλ	I <sub>F</sub> =20mA	-	20	-	nm

# Product Specifications

## Typical Electro-optical Characteristic Curves

(25°C / 77°F Free Air Temperature Unless Otherwise Specified)

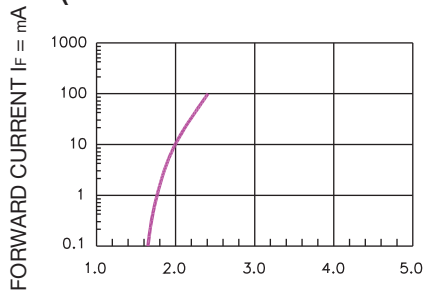

FORWARD CURRENT  $I_F$  (mA)  
FORWARD VOLTAGE  $V_F$  (V)  
FORWARD CURRENT VS. FORWARD VOLTAGE

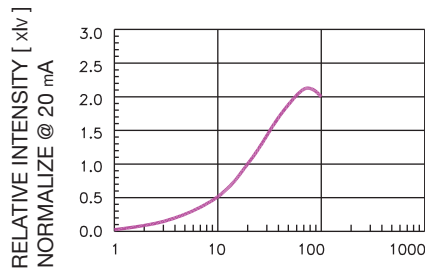

RELATIVE INTENSITY [xlv]  
NORMALIZE @ 20 mA  
FORWARD CURRENT  $I_F$  (mA)  
RELATIVE INTENSITY VS. FORWARD CURRENT

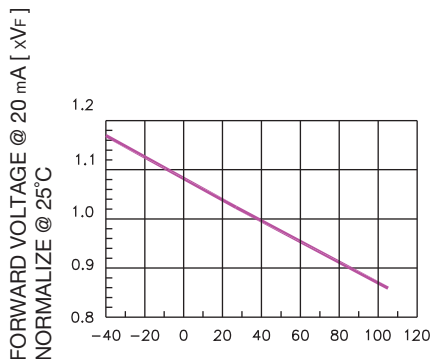

FORWARD VOLTAGE @ 20 mA [xV]  
NORMALIZE @ 25°C  
AMBIENT TEMPERATURE  $T_a$  (°C)  
FORWARD VOLTAGE VS. TEMPERATURE

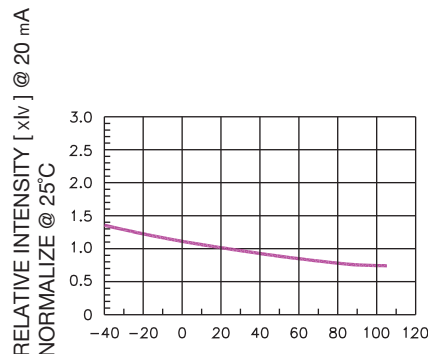

RELATIVE INTENSITY [xlv] @ 20 mA  
NORMALIZE @ 25°C  
AMBIENT TEMPERATURE  $T_a$  (°C)  
RELATIVE INTENSITY VS. TEMPERATURE

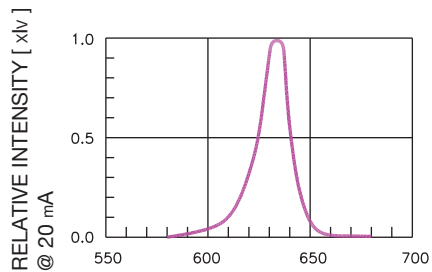

RELATIVE INTENSITY [xlv]  
@ 20 mA  
WAVELENGTH (nm)  
RELATIVE INTENSITY VS. WAVELENGTH

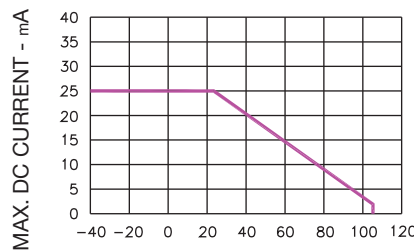

MAX. DC CURRENT - mA  
AMBIENT TEMPERATURE  $T_a$  (°C)  
MAX. ALLOWABLE DC CURRENT VS. AMBIENT TEMPERATURE

## Circuit Design Notes

- Always use current limit resistors when necessary
- LEDs could be electrically connected in parallel, with each LED having its own current limiting resistor

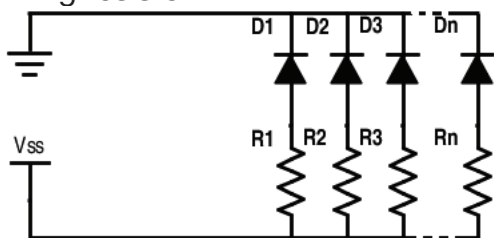

Correct

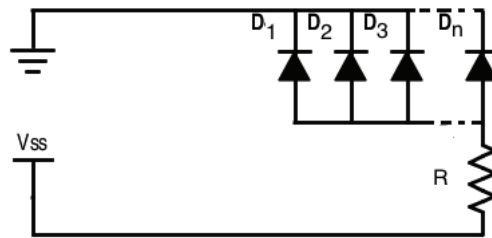

Incorrect

## Recommended Reflow Soldering Profile

- SMT Reflow Soldering Instructions

SMT Soldering Profile  
Pb free reflow soldering Profile

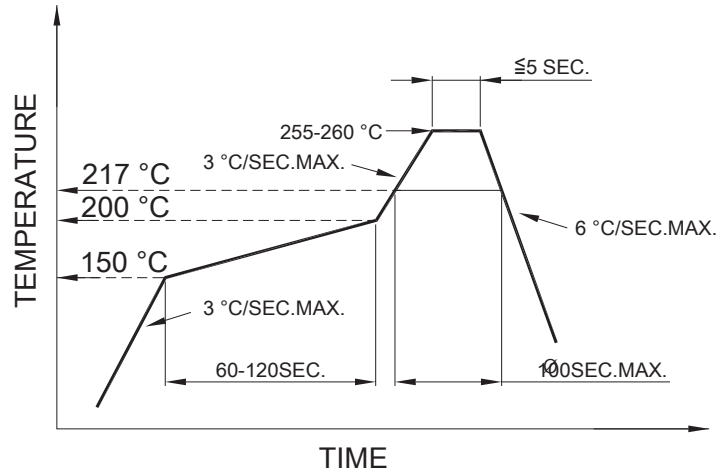

- We recommend the reflow temperature 245°C / 473°F (+/- 5°C / 41°F). The maximum soldering temperature should be limited to 260°C / 500°F.

- Number of reflow process shall be 2 time or less.

- Soldering Iron**

Basic spec is  $\leq 4$  sec when 260°C / 500°F. If temperature is higher, time should be shorter (+10°C / 50°F  $\rightarrow$  1 sec). Power dissipation of Iron should be smaller than 15W, and temperature should be controllable. Surface temperature of the device should be under 230°C / 446°F.

- Rework**

- Customer must finish rework within 3 sec. under 350°C / 662°F.
- The head of soldering iron cannot touch copper foil.

## Storage Condition

In factory original sealed bag package

TEMPERATURE CONDITION	HUMIDITY CONDITION
5°C ~ 30°C	Below 60%RH

After opened and not in factory original sealed bag package

TEMPERATURE CONDITION	HUMIDITY CONDITION	STORAGE TIME
5°C ~ 30°C	Below 60%RH	Within 4 weeks (MSL as level 2a)

## Tape & Reel Dimensions

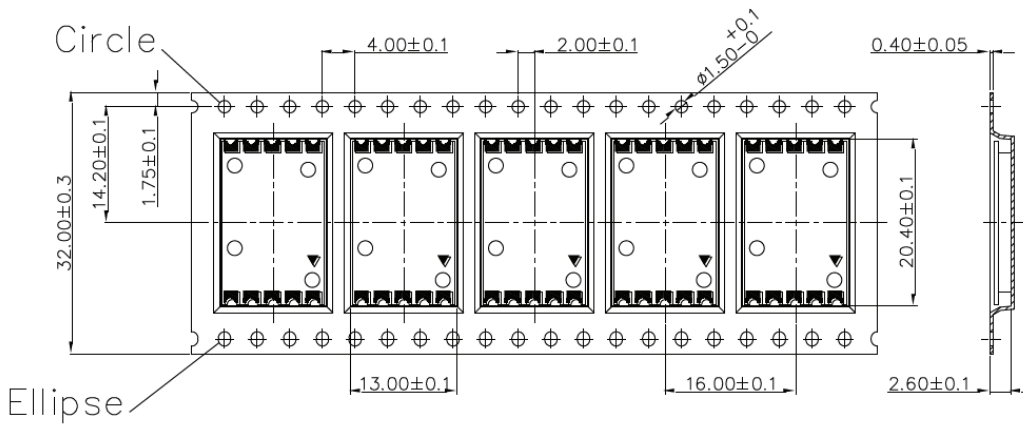
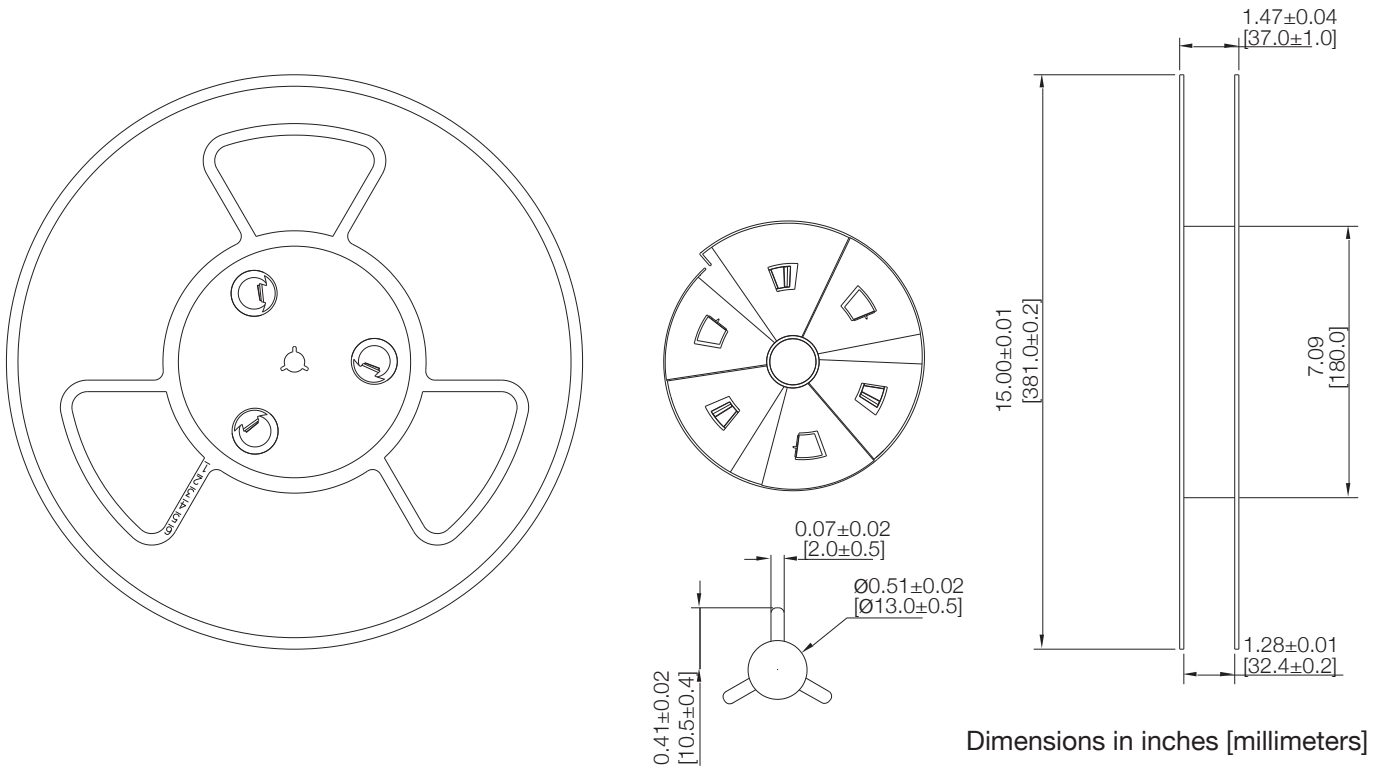

1300PCS / 1 REEL

Dimensions in millimeters

## Compliance and Approvals

