



Chipsmall Limited consists of a professional team with an average of over 10 year of expertise in the distribution of electronic components. Based in Hongkong, we have already established firm and mutual-benefit business relationships with customers from,Europe,America and south Asia,supplying obsolete and hard-to-find components to meet their specific needs.

With the principle of “Quality Parts,Customers Priority,Honest Operation,and Considerate Service”,our business mainly focus on the distribution of electronic components. Line cards we deal with include Microchip,ALPS,ROHM,Xilinx,Pulse,ON,Everlight and Freescale. Main products comprise IC,Modules,Potentiometer,IC Socket,Relay,Connector.Our parts cover such applications as commercial,industrial, and automotives areas.

We are looking forward to setting up business relationship with you and hope to provide you with the best service and solution. Let us make a better world for our industry!



## Contact us

Tel: +86-755-8981 8866 Fax: +86-755-8427 6832

Email & Skype: info@chipsmall.com Web: www.chipsmall.com

Address: A1208, Overseas Decoration Building, #122 Zhenhua RD., Futian, Shenzhen, China



REV.	DATE	DESCRIPTION	REPORT BY	CHECKED BY	APPROVED BY
SPECIFICATION REVISION HISTORY			CUSTOMER : STANDARD PRODUCT CUSTOMER P/N : PART NAME : SOLENOID PUMP DELTA PART NO. : DSP-06090		
00	10/13/2015	- ISSUE			
01	02/13/2017	THE WORKING CYCLE FROM 1 min. ON/ 30 sec. OFF CHANGE TO 30 sec. ON/ 15 sec. OFF			



RoHS Compliant

## SPECIFICATION FOR APPROVAL

TO : \_\_\_\_\_

PAGE : 2/4

CUSTOMER PART NO	REV. 00	DELTA PART NO. DSP-06090	ISSUE DATE Feb.13,2017	TEMP(°C) 25
PART NAME Solenoid Pump		DELTA REV. 01	USED ON	HUM (%) 58 RH

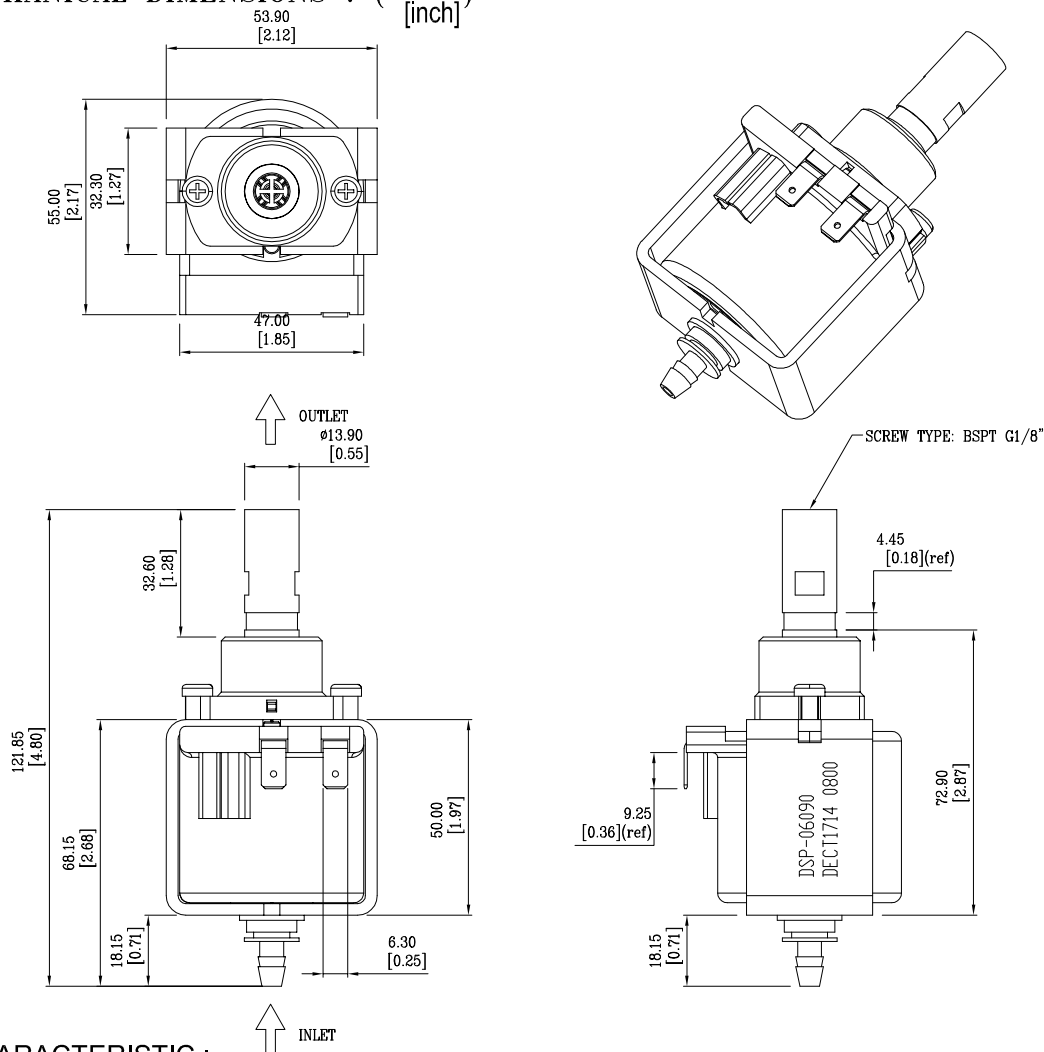
1. MECHANICAL DIMENSIONS : (  $\frac{\text{mm}}{\text{[inch]}}$  )

## 2. CHARACTERISTIC :

- 2-1. OPERATING VOLTAGE: 110Vac / 60Hz
- 2-2. POWER CONSUMPTION: 48W
- 2-3. OUTLET : BSPT G1/8"
- 2-4. FLOW RATE MAX : 900 c.c./min
- 2-5. FLOW RATE TOLERANCE : ±15%
- 2-6. PRESSURE MAX : 87 psi (6 bar)
- 2-7. WATER TEMPERATURE : 20 °C
- 2-8. WORKING CYCLE : 30 sec ON / 15 sec OFF
- 2-9. INTEGRATED DIODE
- 2-10. TEMPERATURE CLASS : F (155°C)
- 2-11. MAX. ON TIME : 11 min



RoHS Compliant

## SPECIFICATION FOR APPROVAL

TO : \_

PAGE : 3/4

CUSTOMER PART NO	REV. 00	DELTA PART NO. DSP-06090	ISSUE DATE Feb.13,2017	TEMP(°C) 25
PART NAME Solenoid Pump		DELTA REV. 01	USED ON	HUM (%) 58 RH

## 2. PRODUCT S/N :

DSP-06090  
DECT1714 0800

## NOTES:

"DSP-06090" IS DELTA P/N  
 "DECT" IS DELTA Chachoengsao plant  
 "1714": 17 IS YEAR ; 14 IS WEEK  
 "0800" : 08 IS SHIP DATE ; 00 IS PRODUCTION LINE OF NO.

## 3. P-Q CURVE :

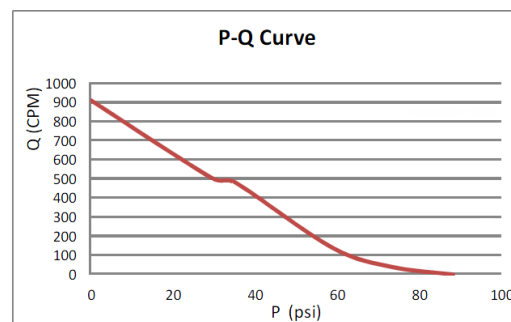
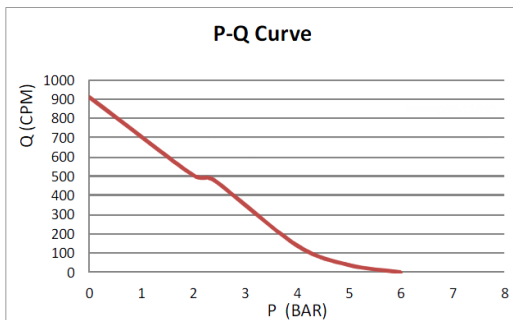

## 4. NOISE TEST : 51.1 dBA ( at p=0 Bar/ 100cm)

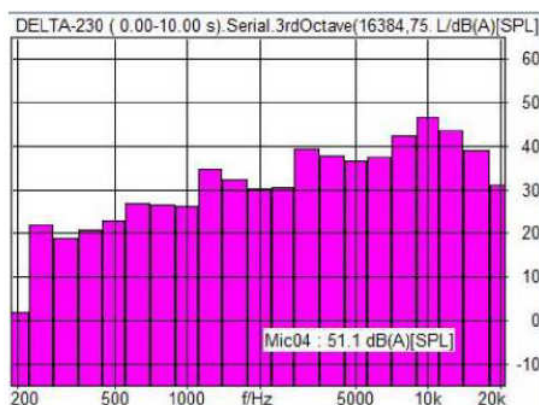



RoHS Compliant

## SPECIFICATION FOR APPROVAL

TO : \_

PAGE : 4/4

CUSTOMER PART NO	REV. 00	DELTA PART NO. DSP-06090	ISSUE DATE Feb.13,2017	TEMP(°C) 25
PART NAME Solenoid Pump		DELTA REV. 01	USED ON	HUM (%) 58 RH

### 5. EMC TEST :

#### 3-1. BACKGROUND

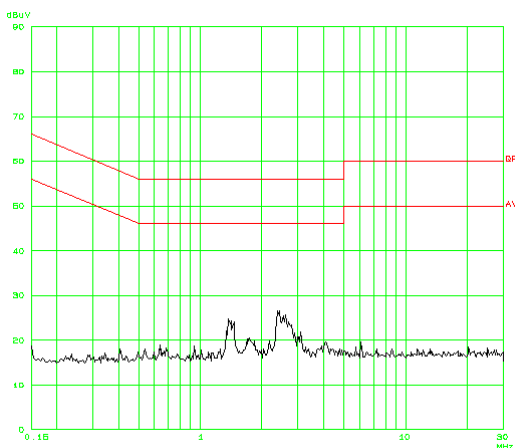

#### 3-2. STANDBY

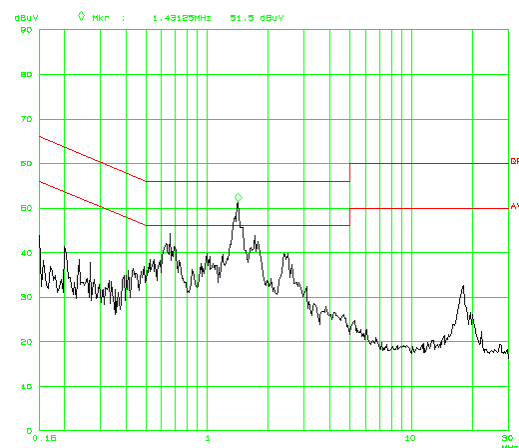

1.43125 MHz QP 49.7dB AV 43dB

#### 3-3. OPERATION

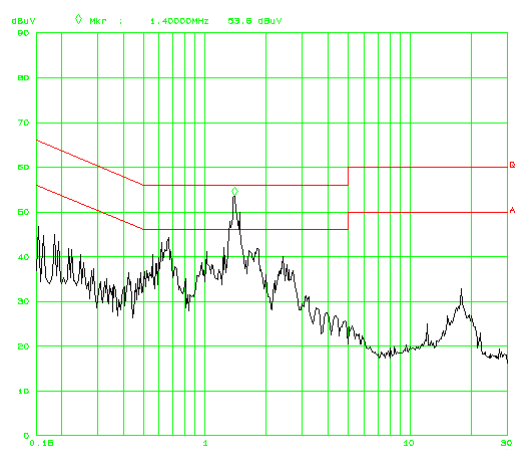

1.4 MHz QP 49dB AV 42.5dB