



Chipsmall Limited consists of a professional team with an average of over 10 year of expertise in the distribution of electronic components. Based in Hongkong, we have already established firm and mutual-benefit business relationships with customers from,Europe,America and south Asia,supplying obsolete and hard-to-find components to meet their specific needs.

With the principle of "Quality Parts,Customers Priority,Honest Operation,and Considerate Service",our business mainly focus on the distribution of electronic components. Line cards we deal with include Microchip,ALPS,ROHM,Xilinx,Pulse,ON,Everlight and Freescale. Main products comprise IC,Modules,Potentiometer,IC Socket,Relay,Connector.Our parts cover such applications as commercial,industrial, and automotives areas.

We are looking forward to setting up business relationship with you and hope to provide you with the best service and solution. Let us make a better world for our industry!



Contact us

Tel: +86-755-8981 8866 Fax: +86-755-8427 6832

Email & Skype: info@chipsmall.com Web: www.chipsmall.com

Address: A1208, Overseas Decoration Building, #122 Zhenhua RD., Futian, Shenzhen, China



EMIFIL® (Three-terminal capacitor)

DSS1NB3□□□□□□□□

Reference Specification

1. Scope

This reference specification applies to DSS1NB3 series.

2. Part Numbering

(Ex.) DS S 1 N B3 2A 220 Q55 B
 ① ② ③ ④ ⑤ ⑥ ⑦ ⑧ ⑨

- ① Product ID (Disc-Type EMIFIL®)
- ② Structure S : Built-in Ferrite Beads Type
- ③ Style
- ④ Features
- ⑤ Temperature Characteristics B3:±10% (-40~+85°C at 20°C)
- ⑥ Rated Voltage 2A :2A→100VDC、1H→50VDC
- ⑦ Capacitance □□□

↓
Marked three digits system.(Ex. 22pF→220、22000pF→223)

- ⑧ Lead Type
Q55 : Bulk
Lead Type :Straight Lead
Lead Length(l) 25.0 mm min. ※See item 9.

- Q91□: Taping
Lead Type :Straight Lead
Dimension H: Q91 : 20.0±1.0 mm
Q92 : 16.5±1.0 mm
Q93 : 18.5±1.0 mm ※See item 9.

- ⑨ Packaging Code A : Ammo Pack / B : Bulk

3. Rating

Operating temperature : -40 to +85°C
 Storage Temperature : -40 to +85°C
 Insulation Resistance : 1000MΩ min.
 Rated Current : 6A(DC)
 Equivalent Circuit :

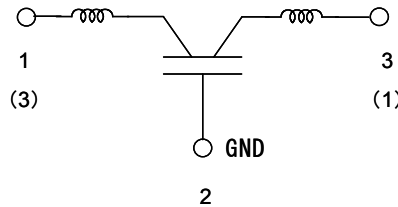

Others : See Table 1

Table 1

Customer Part Number	Murata Part Number	Capacitance	Temperature Characteristics	Rated Voltage	Withstanding Voltage	Unit Mass (Typical value)
	DSS1NB32A220Q55B	22 pF ± 10%	± 10%	100VDC	250VDC	0.45g
	DSS1NB32A220Q91A					
	DSS1NB32A220Q92A					
	DSS1NB32A220Q93A					
	DSS1NB32A330Q55B	33 pF ± 10%				
	DSS1NB32A330Q91A					
	DSS1NB32A330Q92A					
	DSS1NB32A330Q93A					
	DSS1NB32A470Q55B	47 pF ± 10%				
	DSS1NB32A470Q91A					
	DSS1NB32A470Q92A					
	DSS1NB32A470Q93A					

Reference Only

Customer Part Number	Murata Part Number	Capacitance	Temperature Characteristics	Rated Voltage	Withstanding Voltage	Unit Mass (Typical value)
	DSS1NB32A680Q55B	68 pF ± 10%	± 10%	100VDC	250VDC	0.45g
	DSS1NB32A680Q91A					
	DSS1NB32A680Q92A					
	DSS1NB32A680Q93A					
	DSS1NB32A101Q55B	100 pF ± 10%				
	DSS1NB32A101Q91A					
	DSS1NB32A101Q92A					
	DSS1NB32A101Q93A					
	DSS1NB32A121Q55B	120 pF ± 10%				
	DSS1NB32A121Q91A					
	DSS1NB32A121Q92A					
	DSS1NB32A121Q93A					
	DSS1NB32A151Q55B	150 pF ± 10%				
	DSS1NB32A151Q91A					
	DSS1NB32A151Q92A					
	DSS1NB32A151Q93A					
	DSS1NB32A221Q55B	220 pF ± 10%				
	DSS1NB32A221Q91A					
	DSS1NB32A221Q92A					
	DSS1NB32A221Q93A					
	DSS1NB32A271Q55B	270 pF ± 10%				
	DSS1NB32A271Q91A					
	DSS1NB32A271Q92A					
	DSS1NB32A271Q93A					
	DSS1NB32A331Q55B	330 pF ± 10%				
	DSS1NB32A331Q91A					
	DSS1NB32A331Q92A					
	DSS1NB32A331Q93A					
	DSS1NB32A471Q55B	470 pF ± 10%				
	DSS1NB32A471Q91A					
	DSS1NB32A471Q92A					
	DSS1NB32A471Q93A					
	DSS1NB32A681Q55B	680 pF ± 10%				
	DSS1NB32A681Q91A					
	DSS1NB32A681Q92A					
	DSS1NB32A681Q93A					
	DSS1NB32A102Q55B	1000 pF ± 10%				
	DSS1NB32A102Q91A					
	DSS1NB32A102Q92A					
	DSS1NB32A102Q93A					
	DSS1NB32A152Q55B	1500 pF ± 10%				
	DSS1NB32A152Q91A					
	DSS1NB32A152Q92A					
	DSS1NB32A152Q93A					
	DSS1NB32A222Q55B	2200 pF ± 10%				
	DSS1NB32A222Q91A					
	DSS1NB32A222Q92A					
	DSS1NB32A222Q93A					
	DSS1NB32A332Q55B	3300 pF ± 10%				
	DSS1NB32A332Q91A					
	DSS1NB32A332Q92A					
	DSS1NB32A332Q93A					
	DSS1NB32A472Q55B	4700 pF ± 10%				
	DSS1NB32A472Q91A					
	DSS1NB32A472Q92A					
	DSS1NB32A472Q93A					

Customer Part Number	Murata Part Number	Capacitance	Temperature Characteristics	Rated Voltage	Withstanding Voltage	Unit Mass (Typical value)
	DSS1NB32A682Q55B	6800 pF ± 10%	± 10%	100VDC	250VDC	0.45g
	DSS1NB32A682Q91A					
	DSS1NB32A682Q92A					
	DSS1NB32A682Q93A					
	DSS1NB32A103Q55B	10000 pF ± 10%				
	DSS1NB32A103Q91A					
	DSS1NB32A103Q92A					
	DSS1NB32A103Q93A					
	DSS1NB32A153Q55B	15000 pF ± 10%				
	DSS1NB32A153Q91A					
	DSS1NB32A153Q92A					
	DSS1NB32A153Q93A					
	DSS1NB32A223Q55B	22000 pF ± 10%				
	DSS1NB32A223Q91A					
	DSS1NB32A223Q92A					
	DSS1NB32A223Q93A					
	DSS1NB31H333Q55B	33000 pF ± 10%	50VDC	125VDC		
	DSS1NB31H333Q91A					
	DSS1NB31H333Q92A					
	DSS1NB31H333Q93A					
	DSS1NB31H473Q55B	47000 pF ± 10%				
	DSS1NB31H473Q91A					
	DSS1NB31H473Q92A					
	DSS1NB31H473Q93A					
	DSS1NB31H104Q55B	100000pF ± 10%				
	DSS1NB31H104Q91A					
	DSS1NB31H104Q92A					
	DSS1NB31H104Q93A					

4. Style and Dimension

See item 9.

5. Marking

Trade Mark : Marked as 
 Capacitance : Marked three digits system. (Ex.221)
 Rated Voltage : Marked voltage value.(100V)

6. Testing Conditions

<Unless otherwise specified>

Temperature : Ordinary Temperature 15 to 35°C
 Humidity : Ordinary Humidity 25 to 85 %(RH)

<In case of doubt>

Perform a heat treatment at 150+0/-10°C for one hour and then set at room temperature for 24±2 hours.
 Temperature : 20 ± 2°C
 Humidity : 60 to 70 %(RH)
 Atmospheric Pressure : 86 to 106 kPa

7. Performance

No.	Item	Specification	Test Method		
7.1	Appearance and Dimensions	Meet item 9.	Visual Inspection and measured with Slide Calipers.		
7.2	Marking	Marking is able to be read easily.	Visual Inspection.		
7.3	Capacitance and Tolerance	Meet item 3.	Table 2		
			Frequency	Test Voltage	Capacitance
			1±0.1MHz	1±0.2Vrms	22pF~150pF
			1±0.1kHz	1±0.2Vrms	220pF~100000pF
7.4	Insulation Resistance(I.R.)	Meet item 3.	Test Voltage : Rated Voltage Time : 1 minute through a suitable resistor 1MΩ.		

No.	Item	Specification	Test Method												
7.5	Withstanding Voltage	Products shall not be damaged.	Test Voltage : 2.5 times for Rated Voltage Time : 1 to 5 seconds Charge Current : 10 mA max. It shall be applied between input / output terminal and ground terminal.												
7.6	Temperature Characteristics	Meet item 3.	Capacitance shall be measured at each step specified in Table 3 after reaching the thermal equilibrium. The capacitance change against the capacitance at step 3 shall be calculated. <u>Table3</u> <table border="1" style="margin-left: 20px; border-collapse: collapse;"> <tr> <td style="width: 10%;">Step</td> <td style="width: 10%;">1</td> <td style="width: 10%;">2</td> <td style="width: 10%;">3</td> <td style="width: 10%;">4</td> <td style="width: 10%;">5</td> </tr> <tr> <td>Temp. (°C)</td> <td>+20±2</td> <td>40±2</td> <td>+20±2</td> <td>+85±2</td> <td>+20±2</td> </tr> </table>	Step	1	2	3	4	5	Temp. (°C)	+20±2	40±2	+20±2	+85±2	+20±2
Step	1	2	3	4	5										
Temp. (°C)	+20±2	40±2	+20±2	+85±2	+20±2										
7.7	Solderability	Along the circumference of terminal shall be covered with new solder at least 75%.	Flux : Ethanol solution of rosin,25(wt)% (dipped for 5 to 10 seconds) Pre-heat : 150±10°C, 60~90 s Solder : Sn-3.0Ag-0.5Cu Solder Temperature 245±5°C Immersion Time : 2 ± 0.5 seconds Immersion Depth : 2 to 2.5 mm from the bottom of the body.												
7.8	Resistance to Soldering Heat①	Meet Table 4. <u>Table 4</u> <table border="1" style="margin-left: 20px; border-collapse: collapse;"> <tr> <td style="width: 50%;">Appearance</td> <td>No damaged.</td> </tr> <tr> <td>Capacitance Change</td> <td>within ± 30%</td> </tr> <tr> <td>Withstanding Voltage</td> <td>No damaged.</td> </tr> </table>	Appearance	No damaged.	Capacitance Change	within ± 30%	Withstanding Voltage	No damaged.	Flux : Ethanol solution of rosin,25(wt)% (dipped for 5 to 10 seconds) Pre-heat : 150±10°C, 60~90 s Solder : Sn-3.0Ag-0.5Cu Solder Temperature : 270 ± 5 °C Immersion Time : 3± 0.5 seconds Immersion Depth : 1.6 ± 0.7 mm from the bottom of the body. Then measured after exposure in the room condition for 4 to 24hours. Soldering iron output: 30W Tip temperature : 370±10°C Soldering time : 5s(+0/-1s)						
	Appearance	No damaged.													
Capacitance Change	within ± 30%														
Withstanding Voltage	No damaged.														
Resistance to Soldering Heat②															
7.9	Humidity	Meet Table 5. <u>Table 5</u> <table border="1" style="margin-left: 20px; border-collapse: collapse;"> <tr> <td style="width: 50%;">Appearance</td> <td>No damaged.</td> </tr> <tr> <td>Capacitance Change</td> <td>within ± 30%</td> </tr> </table>	Appearance	No damaged.	Capacitance Change	within ± 30%	Temperature : 60°C Humidity : 90 to 95 %(RH) Time : 500 hours(+24-0 hours) Then measured after exposure in the room condition for 4 to 24hours.								
Appearance	No damaged.														
Capacitance Change	within ± 30%														
7.10	Humidity Life	<table border="1" style="margin-left: 20px; border-collapse: collapse;"> <tr> <td style="width: 50%;">Insulation Resistance</td> <td>10MΩ min.</td> </tr> </table>	Insulation Resistance	10MΩ min.	Temperature : 40 ± 2°C Humidity : 90 to 95 %(RH) Time : 500 hours(+24-0 hours) Applying Voltage : 1H/ Rated Voltage 50VDC 2A/ Rated Voltage 100VDC Then measured after exposure in the room condition for 4 to 24hours.										
Insulation Resistance	10MΩ min.														
7.11	Heat Life		Temperature : 85 ± 3°C Applying Voltage : 1H/ Rated Voltage 50VDC 2A/ Rated Voltage 100VDC Time : 500 hours(+24-0 hours) Then measured after exposure in the room condition for 4 to 24hours.												

8. Mounting Hole

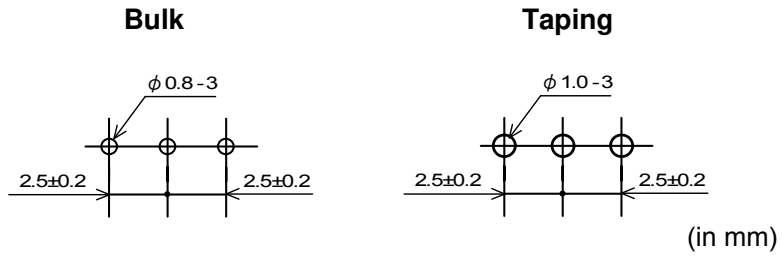

9. Style and Dimension

9.1 Bulk(Straight Lead Type) : Q55B

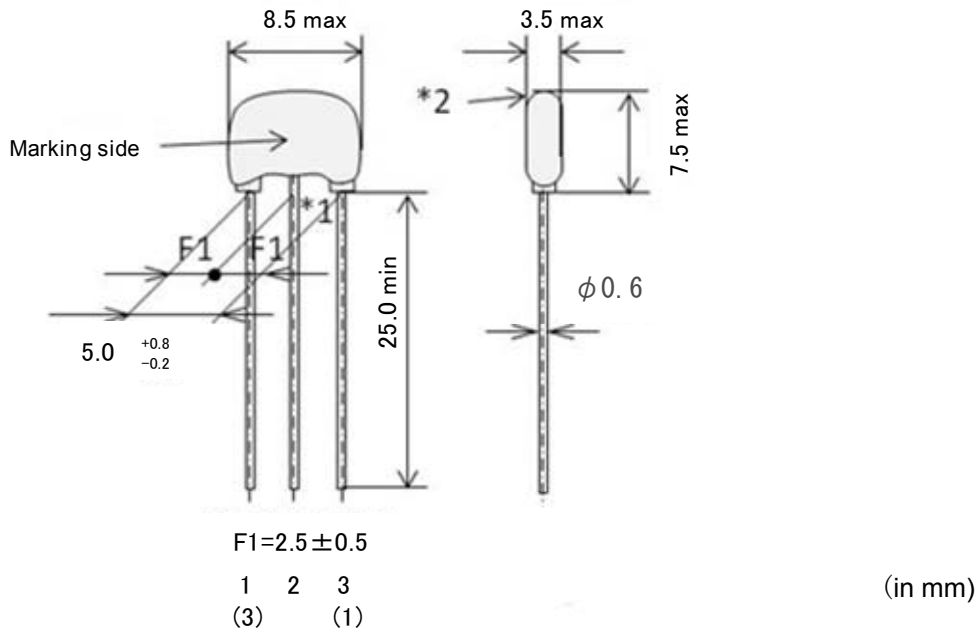

F1=2.5±0.5

1	2	3
(3)		(1)

*1. Bottom of dielectric may be exposed.

*2. There should not be the exposure of the ferrite bead if a hole is on the top of ferrite bead.

9.2 Taping(Straight Lead Type) : Q9□A

(All symbols in the illustrations below are described in Table 4)

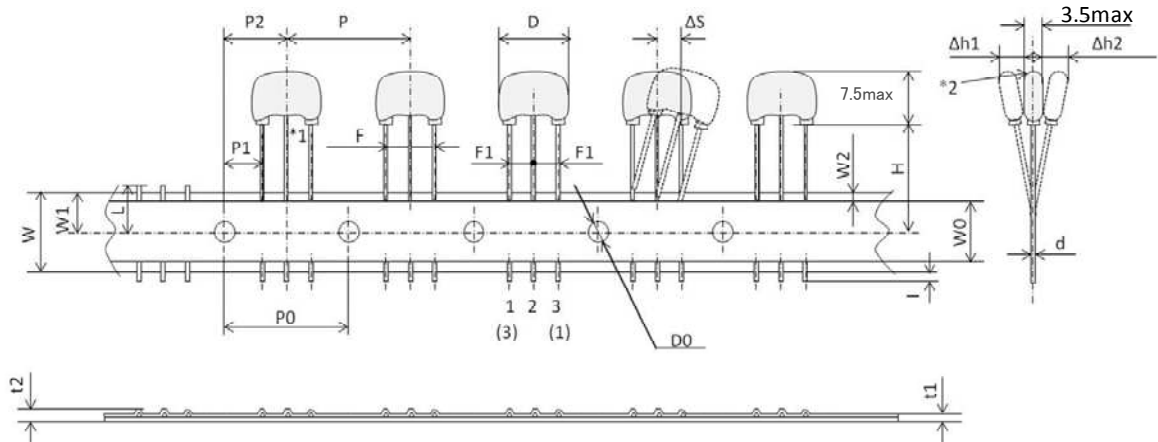

*1.Bottom of dielectric may be exposed.

*2.There should not be the exposure of the ferrite bead if a hole is on the top of ferrite bead.

Table 4

Code	Description	Dimensions	Remark
P	Pitch of Component	12.7	Product Inclination ΔS Determines Crossing
P0	Pitch of Sprocket Hole	12.7±0.2	
P1	Length from Hole Center to Lead	3.85±0.7	
P2	Length from Hole Center to Component Center	6.35±1.3	
D	Width of Body	8.5 max.	
ΔS	Deviation along tape, Left or Right	0±1.0	
W	Carrier Tape Width	18.0±0.5	
W1	Position of Sprocket Hole	9.0 +0,-0.5	Tape Widthwise Shift
l	Protrusion Length	+0.5 ~ -1.0	
D0	Diameter of Sprocket Hole	φ 4.0±0.1	
d	Lead Diameter	φ 0.6	
t1	Total Tape Thickness	0.7±0.2	Includes Thickness of Bonding Tape
t2	Total Thickness, Tape and Lead Wire	1.5 max.	
Δh1	Deviation across Tape, front	1.0 max.	
Δh2	Deviation across Tape, rear	1.0 max.	
L	Portion to Cut in Case of Defect	11.0 +0,-1.0	
W0	Hold Down Tape Width	12.0±0.5	
W2	Hold Down Tape Position	1.5±1.5	
H	Lead length between sprocket hole and forming position	Q91	20.0±1.0
		Q92	16.5±1.0
		Q93	18.5±1.0
F	Lead Spacing	5.0 +0.8,-0.2	
F1		2.5 +0.4,-0.2	

(in mm)

10. Taping

- (1) A maximum of 0.3% of the components quantity per Ammo pack may be missing without consecutive missing components.
- (2) The adhesive power of the tape shall have over 2.94N at the following condition.

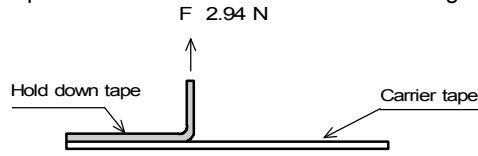

(3) Splicing method of tape

1. Carrier tape

Carrier tape shall be spliced by cellophane tape.
Overall thickness shall be less than 1.05 mm.

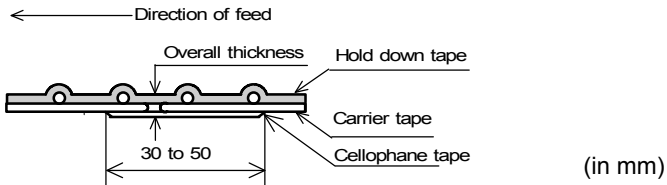

2. Hold down tape

Hold down tape shall be spliced with overlapping.
Overall thickness shall be less than 1.05 mm.

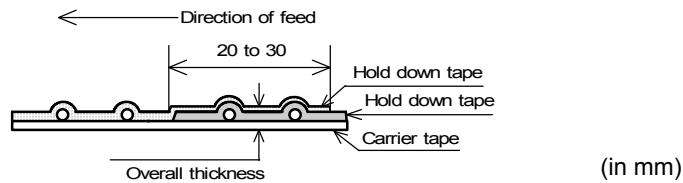

3. Both carrier tape and hold down tape

Both tapes shall be cut zigzag and spliced with splicing tape.

11. Packing

11.1 Packing quantity

The standard packing quantity is as follows.

(The packing quantity may be changed due to a fraction of order.)

Minimum Packing Form and Quantity

Terminal Configuration	A Unit Quantity	Packing Form	* Standard Quantity in a container (corrugated cardboard box)
Bulk	250 pcs.	In a plastic bag	5000pcs.
Taping	1500 pcs.	In an Ammo pack	7500pcs.

* A quantity in a container is depending on a quantity of an order.

11.2 Packing Form

(1) Bulk

<A plastic bag pack>

1. Products are packed into a plastic bag.

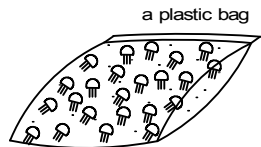

2. The plastic bags are put into a container (corrugated cardboard box) depending on a quantity of an order.

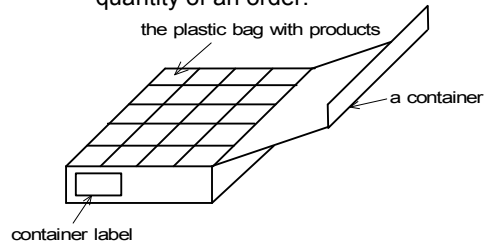

(2) Taping

<An ammo pack>

1. Folding the tape per 25 pitches, products are packed into an ammo package so that each product of each layer wound zigzag is put on top of one another. [Fig 3]
2. The dimensions of the ammo package are indicated in [Fig 4].
3. The ammo packages are put into a container (corrugated cardboard box) depending on a quantity of an order.
4. Not less than 3 consecutive of component shall be missing on both edge of tape.

[Fig 3] zig zag

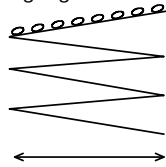

The unloading direction : Right
 The hold down tape : Upper
 The product body : Left along the unloading direction

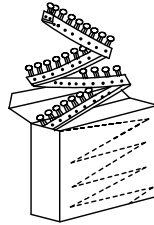

[Fig 4]

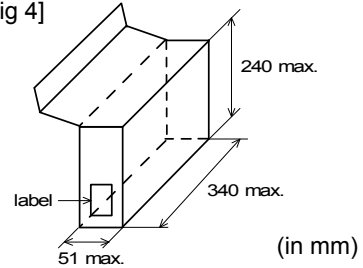

(in mm)

12. Marking on package

12.1 Unit Package

Bulk : Marked on a plastic bag.

Taping : Marked on a label stuck on an ammo package.

Marking on a unit package consists of :

Customer part number, MURATA part number, Inspection number(*1), RoHS marking (*2), Quantity, etc

*1) « Expression of Inspection No. »

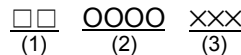

(1) Factory Code

(2) Date

First digit : Year / Last digit of year

Second digit : Month / Jan. to Sep. → 1 to 9, Oct. to Dec. → O,N,D

Third, Fourth digit : Day

(3) Serial No.

*2) « Expression of RoHS marking »

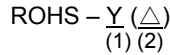

(1) RoHS regulation conformity parts.

(2) MURATA classification number

12.2 Container

Marking on the label stuck on a container consists of :

Customer name Purchasing Order Number, Customer Part Number, MURATA part number, RoHS marking (*2), Quantity, etc

13. ⚠ Caution

13.1 Mounting holes

Mounting holes should be designed as specified in this specifications.

Or different design from this specifications may cause cracks in ceramics which may lead to smoking / firing.

13.2 Caution for the product angle adjust work

Take care not to apply any mechanical stress to product body at the lead terminal bending process for product angle adjustment after insertion.

13.3 Limitation of Applications

Please contact us before using our products for the applications listed below which require especially high reliability for the prevention of defects which might directly cause damage to the third party's life, body or property.

- | | |
|--|--|
| (1) Aircraft equipment | (7) Traffic signal equipment |
| (2) Aerospace equipment | (7) Disaster prevention / crime prevention equipment |
| (3) Undersea equipment | (9) Data-processing equipment |
| (4) Power plant control equipment | (10) Applications of similar complexity and /or reliability requirements |
| (5) Medical equipment | to the applications listed in the above |
| (6) Transportation equipment (vehicles, trains, ships, etc.) | |

14. Notice**14.1 Soldering**

- (1) Use rosin-based flux. Do not use strong acidic flux with halide content exceeding 0.2(wt)% (chlorine conversion value).
Use Sn-3.0Ag-0.5Cu solder

- (2) Standard flow soldering profile.

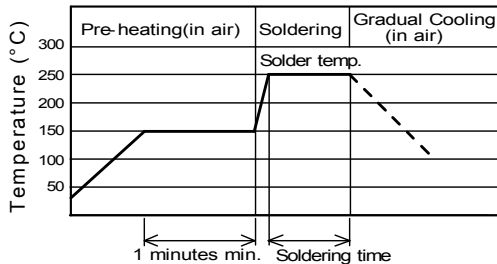

- (3) Resistance to soldering iron goes in the following condition that tip temperature is 350 °C max. And soldering time is 5 s max.
(4) Products and the leads should not be subjected to any mechanical stress during soldering process. (and also while subjected to the equivalent high temperature.)

14.2 Cleaning

Products shall be cleaned on following conditions.

- (1) Cleaning Temperature: 60°C max. (40°C max. for Isopropyl alcohol).
(2) Ultrasonic cleaning shall comply with the following conditions, avoiding the resonance phenomenon at the mounted products and P.C.B.
Power : 20W / l max.
Frequency : 28kHz ~ 40kHz
Time : 5 minutes max.
(3) Cleaning agent
1. alcohol cleaning agents.
• Isopropyl alcohol (IPA)
2. Aqueous cleaning agent
• Pine Alpha ST-100S
(4) Ensure that residual flux and residual cleaning agent is completely removed.
Products should be thoroughly dried after aqueous agent has been removed with de-ionized water.
(5) For other cleaning methods, please contact Murata engineering.

14.3 Operating Environment

- (1) Do not use products in corrosive gases such as chlorine gas, acid or sulfide gas.
(2) Do not use products in the environment where water, oil or organic solvents may adhere to products.
(3) Do not adhere any resin to products, coat nor mold products with any resin (including adhesive) to prevent mechanical and chemical stress on products.

14.4 Storage and handling requirements.

- (1) Storage period
Use the products within 12 months after delivered.
Solderability should be checked if this period is exceeded.
(2) Storage environment condition
To prevent products quality deterioration, stored conditions should be controlled as follows ;
1. Temperature : -10 to 40 degrees centigrade
2. Humidity : 15 to 85% relative humidity
3. Products should be stored without sudden changes in temperature and humidity.
Don't keep products in corrosive gases such as sulfur, chlorine gas or acid,
or it may cause oxidization of lead terminals resulting in poor solderability.
4. Products should be stored on the palette for the prevention of the influence from humidity, dust and so on.
5. Products should be stored in the warehouse without heat shock, vibration, direct sunlight and so on.
(3) Handling Conditions
Care should be taken when transporting or handling product to avoid excessive vibration or mechanical shock.

15.  Note

- (1) Please make sure that your product has been evaluated in view of your specifications with our product being mounted to your product.
- (2) You are requested not to use our product deviating from the reference specifications.
- (3) The contents of this reference specification are subject to change without advance notice. Please approve our product specifications or transact the approval sheet for product specifications before ordering.