



Chipsmall Limited consists of a professional team with an average of over 10 year of expertise in the distribution of electronic components. Based in Hongkong, we have already established firm and mutual-benefit business relationships with customers from,Europe,America and south Asia,supplying obsolete and hard-to-find components to meet their specific needs.

With the principle of “Quality Parts,Customers Priority,Honest Operation,and Considerate Service”,our business mainly focus on the distribution of electronic components. Line cards we deal with include Microchip,ALPS,ROHM,Xilinx,Pulse,ON,Everlight and Freescale. Main products comprise IC,Modules,Potentiometer,IC Socket,Relay,Connector.Our parts cover such applications as commercial,industrial, and automotives areas.

We are looking forward to setting up business relationship with you and hope to provide you with the best service and solution. Let us make a better world for our industry!



Contact us

Tel: +86-755-8981 8866 Fax: +86-755-8427 6832

Email & Skype: info@chipsmall.com Web: www.chipsmall.com

Address: A1208, Overseas Decoration Building, #122 Zhenhua RD., Futian, Shenzhen, China





Micro Commercial Components



Micro Commercial Components
 20736 Marilla Street Chatsworth
 CA 91311
 Phone: (818) 701-4933
 Fax: (818) 701-4939

DTA124EE

PNP Digital Transistors

Features

- Lead Free Finish/RoHS Compliant ("P" Suffix designates RoHS Compliant. See ordering information)
- Epoxy meets UL 94 V-0 flammability rating
- Moisture Sensitivity Level 1
- Built-in bias resistors enable the configuration of an inverter circuit without connecting external input resistors
- The bias resistors consist of thin-film resistors with complete isolation to allow negative biasing of the input. They also have the advantage of almost completely eliminating parasitic effects.
- Only the on/off conditions need to be set for operation, making device design easy
- Halogen free available upon request by adding suffix "-HF"

Absolute maximum ratings @ 25°C

Symbol	Parameter	Min	Typ	Max	Unit
V_{CC}	Supply voltage	---	-50	---	V
V_{IN}	Input voltage	-40	---	10	V
I_O	Output current	---	-30	---	mA
$I_{C(MAX)}$		---	-100	---	
P_d	Power dissipation	---	150	---	mW
T_j	Junction temperature	---	150	---	°C
T_{stg}	Storage temperature	-55	---	150	°C

Electrical Characteristics @ 25°C

Symbol	Parameter	Min	Typ	Max	Unit
$V_{I(off)}$	Input voltage ($V_{CC}=-5V, I_O=-100 \mu A$)	---	---	-0.5	V
$V_{I(on)}$	($V_O=0.2V, I_O=-5mA$)	-3.0	---	---	V
$V_{O(on)}$	Output voltage ($I_O/I_I=-10mA/-0.5mA$)	---	---	-0.3	V
I_I	Input current ($V_I=-5V$)	---	---	-0.36	mA
$I_{O(off)}$	Output current ($V_{CC}=-50V, V_I=0$)	---	---	-0.5	μA
G_I	DC current gain ($V_O=-5V, I_O=-5mA$)	56	---	---	
R_1	Input resistance	15.4	22	28.6	$K \Omega$
R_2/R_1	Resistance ratio	0.8	1.0	1.2	
f_T	Transition frequency ($V_{CE}=-10V, I_E=5mA, f=100MHz$)	---	250	---	MHz

Equivalent circuit

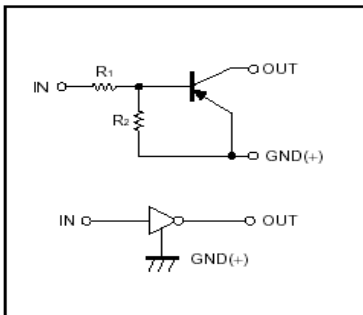

*Marking: 15

SOT-523

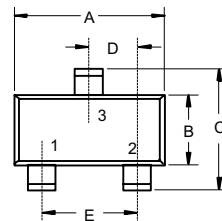

1. IN
2. GND
3. OUT

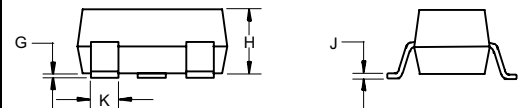

DIM	INCHES		MM		NOTE
	MIN	MAX	MIN	MAX	
A	.059	.067	1.50	1.70	
B	.030	.033	0.75	0.85	
C	.057	.069	1.45	1.75	
D	.020 Nominal		0.50 Nominal		
E	.035	.043	0.90	1.10	
G	.000	.004	.000	.100	
H	.028	.031	.70	0.80	
J	.004	.008	.100	.200	
K	.010	.014	.25	.35	

● Electrical characteristic curves

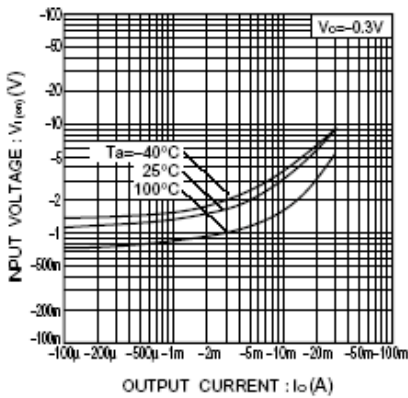

Fig.1 Input voltage vs. output current (ON characteristics)

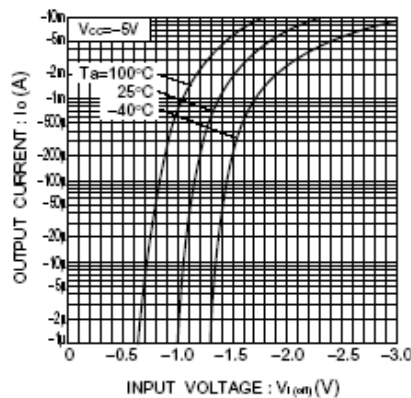

Fig.2 Output current vs. input voltage (OFF characteristics)

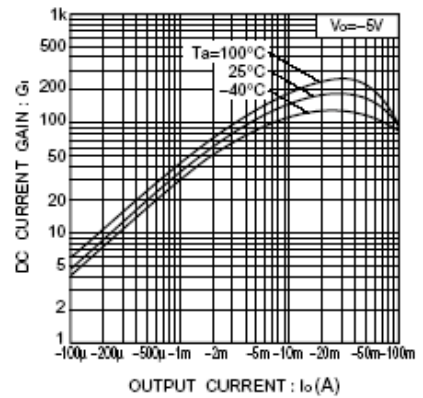

Fig.3 DC current gain vs. output current

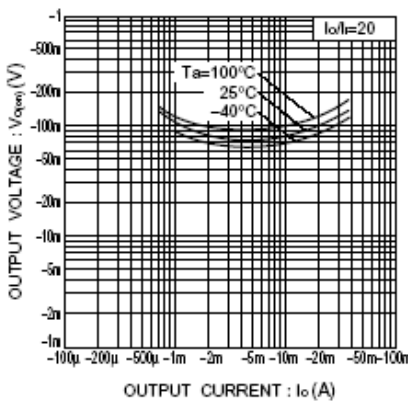

Fig.4 Output voltage vs. output current



Micro Commercial Components

Ordering Information :

Device	Packing
Part Number-TP	Tape & Reel; 3 Kpcs/Reel

Note : Adding "-HF" suffix for halogen free, eg. Part Number-TP-HF

*****IMPORTANT NOTICE*****

Micro Commercial Components Corp. reserves the right to make changes without further notice to any product herein to make corrections, modifications, enhancements, improvements, or other changes. **Micro Commercial Components Corp.** does not assume any liability arising out of the application or use of any product described herein; neither does it convey any license under its patent rights, nor the rights of others. The user of products in such applications shall assume all risks of such use and will agree to hold **Micro Commercial Components Corp.** and all the companies whose products are represented on our website, harmless against all damages.

*****LIFE SUPPORT*****

MCC's products are not authorized for use as critical components in life support devices or systems without the express written approval of Micro Commercial Components Corporation.

*****CUSTOMER AWARENESS*****

Counterfeiting of semiconductor parts is a growing problem in the industry. Micro Commercial Components (MCC) is taking strong measures to protect ourselves and our customers from the proliferation of counterfeit parts. MCC strongly encourages customers to purchase MCC parts either directly from MCC or from Authorized MCC Distributors who are listed by country on our web page cited below. Products customers buy either from MCC directly or from Authorized MCC Distributors are genuine parts, have full traceability, meet MCC's quality standards for handling and storage. **MCC will not provide any warranty coverage or other assistance for parts bought from Unauthorized Sources.** MCC is committed to combat this global problem and encourage our customers to do their part in stopping this practice by buying direct or from authorized distributors.

www.mccsemi.com