



Chipsmall Limited consists of a professional team with an average of over 10 year of expertise in the distribution of electronic components. Based in Hongkong, we have already established firm and mutual-benefit business relationships with customers from,Europe,America and south Asia,supplying obsolete and hard-to-find components to meet their specific needs.

With the principle of "Quality Parts,Customers Priority,Honest Operation,and Considerate Service",our business mainly focus on the distribution of electronic components. Line cards we deal with include Microchip,ALPS,ROHM,Xilinx,Pulse,ON,Everlight and Freescale. Main products comprise IC,Modules,Potentiometer,IC Socket,Relay,Connector.Our parts cover such applications as commercial,industrial, and automotives areas.

We are looking forward to setting up business relationship with you and hope to provide you with the best service and solution. Let us make a better world for our industry!



## Contact us

Tel: +86-755-8981 8866 Fax: +86-755-8427 6832

Email & Skype: info@chipsmall.com Web: www.chipsmall.com

Address: A1208, Overseas Decoration Building, #122 Zhenhua RD., Futian, Shenzhen, China



# Digital transistors (built-in resistors)

## DTC363EU / DTC363EK / DTC363ES

### ●Features

In addition to the features of regular digital transistors,

1) Low  $V_{O(on)}$  makes these transistors optimal for muting circuits.

$V_{O(on)} = 40\text{mV (typ.)}$

( $I_o / I_i = 50\text{mA} / 2.5\text{mA}$ )

2) They can be used at high current ( $I_c = 600\text{mA}$ ).

### ●Structure

NPN digital transistor  
(Built-in resistor type)

### ●Equivalent circuit

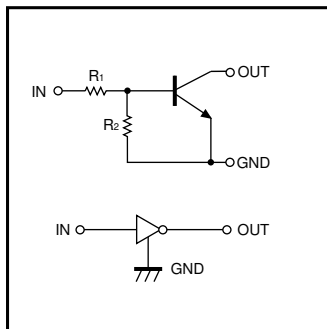

### ●External dimensions (Unit : mm)

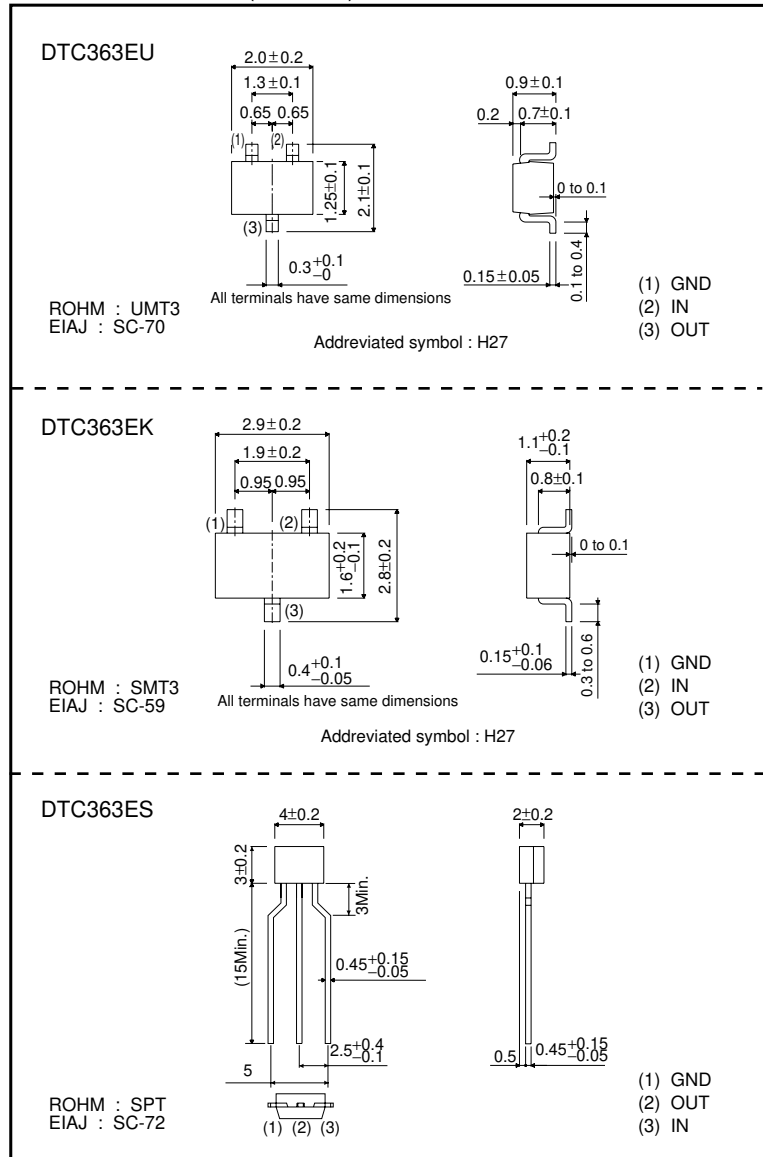

Transistors

●Absolute maximum ratings (Ta=25°C)

Parameter	Symbol	Limits(DTC363E□)			Unit
		U	K	S	
Supply voltage	V <sub>CC</sub>	20			V
Input voltage	V <sub>IN</sub>	-10 to +10			V
Output current	I <sub>c</sub>	600			mA
Power dissipation	P <sub>d</sub>	200	300		mW
Junction temperature	T <sub>j</sub>	150			°C
Storage temperature	T <sub>stg</sub>	-55 to +150			°C

●Electrical characteristics (Ta=25°C)

Parameter	Symbol	Min.	Typ.	Max.	Unit	Conditions
Input voltage	V <sub>I(off)</sub>	-	-	0.5	V	V <sub>CC</sub> =5V, I <sub>O</sub> =100μA
	V <sub>I(on)</sub>	2	-	-		V <sub>O</sub> =0.3V, I <sub>O</sub> =10mA
Output voltage	V <sub>O(on)</sub>	-	40	80	mV	I <sub>O</sub> /I <sub>I</sub> =50mA/2.5mA
Input current	I <sub>I</sub>	-	-	1.3	mA	V <sub>I</sub> =5V
Output current	I <sub>O(off)</sub>	-	-	0.5	μA	V <sub>CC</sub> =15V, V <sub>I</sub> =0V
DC current gain	G <sub>I</sub>	70	-	-	-	V <sub>O</sub> =5V, I <sub>O</sub> =50mA
Input resistance	R <sub>I</sub>	4.76	6.8	8.84	kΩ	-
Resistance ratio	R <sub>2</sub> /R <sub>1</sub>	0.8	1	1.2	-	-
Transition frequency	f <sub>T</sub>	-	200	-	MHz	V <sub>CE</sub> =10V, I <sub>E</sub> =-50mA, f=100MHz *
Output "ON" resistance	R <sub>on</sub>	-	1.0	-	Ω	V <sub>I</sub> =7V, R <sub>L</sub> =1kΩ, f=1kHz

\*Transition frequency of the device

●Packaging specifications

Part No.	Package	UMT3	SMT3	SPT
	Package type	Taping	Taping	Taping
	Code	T106	T146	TP
	Basic ordering unit (pieces)	3000	3000	5000
DTC363EU		○	-	-
DTC363EK		-	○	-
DTC363ES		-	-	○

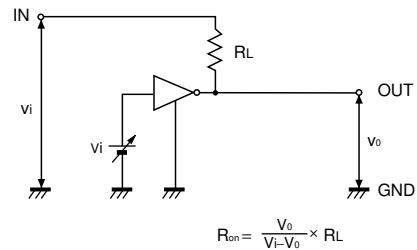

Fig.1 Input "ON" resistance (R<sub>on</sub>) measurement circuit

●R<sub>on</sub> measurement circuit

Transistors

●Electrical characteristic curves

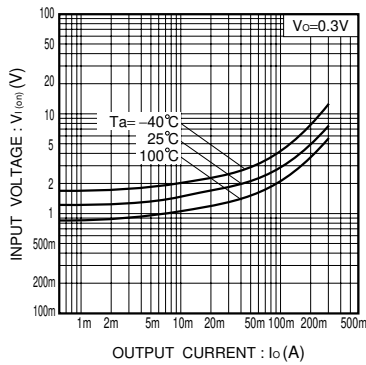

Fig.2 Input voltage vs. output current (ON characteristics)

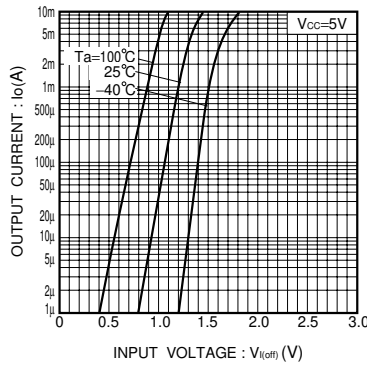

Fig.3 Output current vs. input voltage (OFF characteristics)

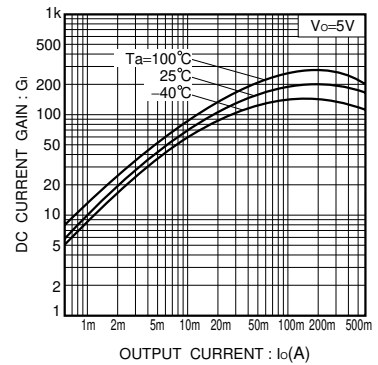

Fig.4 DC current gain vs. output current

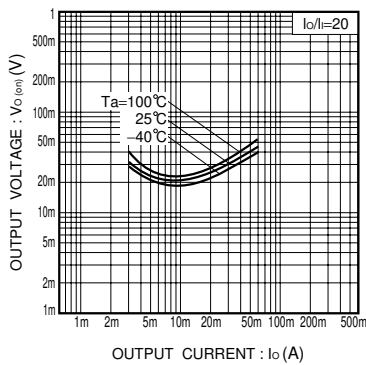

Fig.5 Output voltage vs. output current

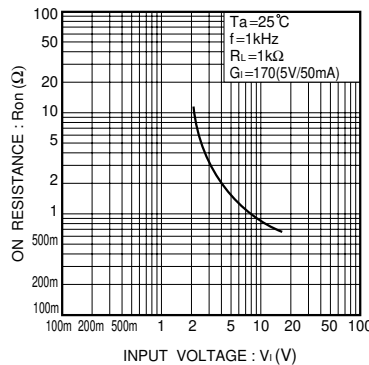

Fig.6 "ON" resistance vs. input voltage

### Notes

- No technical content pages of this document may be reproduced in any form or transmitted by any means without prior permission of ROHM CO.,LTD.
- The contents described herein are subject to change without notice. The specifications for the product described in this document are for reference only. Upon actual use, therefore, please request that specifications to be separately delivered.
- Application circuit diagrams and circuit constants contained herein are shown as examples of standard use and operation. Please pay careful attention to the peripheral conditions when designing circuits and deciding upon circuit constants in the set.
- Any data, including, but not limited to application circuit diagrams information, described herein are intended only as illustrations of such devices and not as the specifications for such devices. ROHM CO.,LTD. disclaims any warranty that any use of such devices shall be free from infringement of any third party's intellectual property rights or other proprietary rights, and further, assumes no liability of whatsoever nature in the event of any such infringement, or arising from or connected with or related to the use of such devices.
- Upon the sale of any such devices, other than for buyer's right to use such devices itself, resell or otherwise dispose of the same, no express or implied right or license to practice or commercially exploit any intellectual property rights or other proprietary rights owned or controlled by
- ROHM CO., LTD. is granted to any such buyer.
- Products listed in this document are no antiradiation design.

The products listed in this document are designed to be used with ordinary electronic equipment or devices (such as audio visual equipment, office-automation equipment, communications devices, electrical appliances and electronic toys).

Should you intend to use these products with equipment or devices which require an extremely high level of reliability and the malfunction of which would directly endanger human life (such as medical instruments, transportation equipment, aerospace machinery, nuclear-reactor controllers, fuel controllers and other safety devices), please be sure to consult with our sales representative in advance.

#### About Export Control Order in Japan

Products described herein are the objects of controlled goods in Annex 1 (Item 16) of Export Trade Control Order in Japan.

In case of export from Japan, please confirm if it applies to "objective" criteria or an "informed" (by MITI clause) on the basis of "catch all controls for Non-Proliferation of Weapons of Mass Destruction.