



Chipsmall Limited consists of a professional team with an average of over 10 year of expertise in the distribution of electronic components. Based in Hongkong, we have already established firm and mutual-benefit business relationships with customers from,Europe,America and south Asia,supplying obsolete and hard-to-find components to meet their specific needs.

With the principle of “Quality Parts,Customers Priority,Honest Operation,and Considerate Service”,our business mainly focus on the distribution of electronic components. Line cards we deal with include Microchip,ALPS,ROHM,Xilinx,Pulse,ON,Everlight and Freescale. Main products comprise IC,Modules,Potentiometer,IC Socket,Relay,Connector.Our parts cover such applications as commercial,industrial, and automotives areas.

We are looking forward to setting up business relationship with you and hope to provide you with the best service and solution. Let us make a better world for our industry!



Contact us

Tel: +86-755-8981 8866 Fax: +86-755-8427 6832

Email & Skype: info@chipsmall.com Web: www.chipsmall.com

Address: A1208, Overseas Decoration Building, #122 Zhenhua RD., Futian, Shenzhen, China





Product Overview: DWM1001-DEV

DWM1001 Module Development Board

- Plug-and-Play Development Board for evaluating the performance of the Decawave DWM1001 module
- Easily assemble a fully wireless RTLS system, including anchors, tags & gateways, without designing any hardware or writing a single line of code – and quickly progress into developing your application

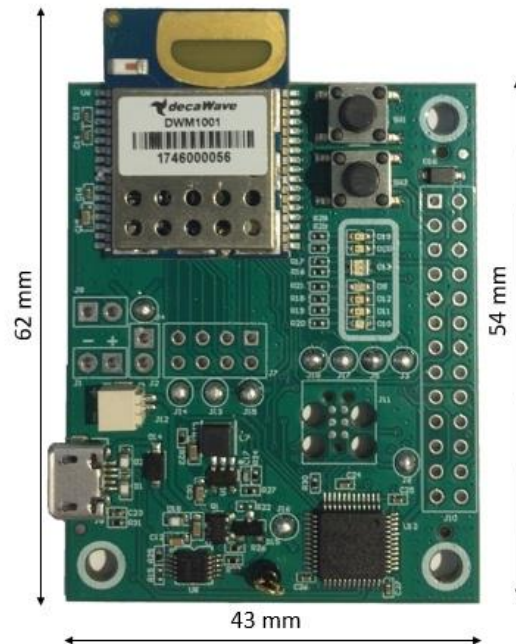

Key Features and Benefits

- DWM1001 module mounted (See DWM1001 data sheet for details)
- USB connection for reprogramming, debug & power supply
- On board JLINK
- External API via SPI, UART & BLE for configuration & control
- 26-pin Raspberry Pi compatible header
- Reset and user-defined buttons and LEDs
- Battery charging circuit
- Allows access to DWM1001 pins (castellation) via on board headers

Table of Contents

1 OVERVIEW	4	7 BUTTONS SW1 AND SW2	11
1.1 SUITABLE POWER SUPPLY OPTIONS	5	8 DEVELOPMENT BOARD SOLDER BRIDGE	
1.2 BLOCK DIAGRAM OF THE DEVELOPMENT BOARD .	5	JUMPERS	12
2 DWM1001 MODULE.....	6	9 DEVELOPMENT BOARD SCHEMATIC	13
3 RASPBERRY PI INTERFACE	6	10 REFERENCES	14
3.1 MEANS OF CONNECTION.....	6	11 DOCUMENT HISTORY	14
3.2 DWM1001 MODULE PIN TO RASPBERRY PI		12 MAJOR CHANGES	14
CONNECTOR MAPPING	7	13 ABOUT DECAWAVE	15
4 THE DEVELOPMENT BOARD LEDS.....	9		
5 ON BOARD JLINK.....	10		
6 POWER SUPPLY AND BATTERY CONNECTIONS	11		

List of Figures

FIGURE 1 THE MAIN COMPONENTS OF THE MODULE DEVELOPMENT BOARD ARE SHOWN	4	FIGURE 7: HEADER CONNECTOR WITH EXTENDED PIN LENGTHS	7
FIGURE 2: THE MODULE DEVELOPMENT BOARD CAN BE USED TO CREATE AN ANCHOR, A TAG OR A GATEWAY	4	FIGURE 8: PIN DESIGNATIONS OF THE RASPBERRY PI MODEL A VARIANT.....	8
FIGURE 3: MODULE DEVELOPMENT BOARD USED AS AN ANCHOR, TAG OR GATEWAY DEVICE, IN AN RTLS SYSTEM.....	4	FIGURE 9: PIN DESIGNATIONS OF THE RASPBERRY PI MODEL B VARIANT.....	8
FIGURE 4: THE MAIN SECTIONS OF THE DWM1001 MODULE DEVELOPMENT BOARD	5	FIGURE 10: FRONT VIEW OF THE DWM1001-DEV MODULE DEVELOPMENT BOARD	9
FIGURE 5: BLOCK DIAGRAM OF DWM1001 MODULE	6	FIGURE 11: MODULE DEVELOPMENT BOARD JLINK COMPONENTS	10
FIGURE 6: RASPBERRY PI MODEL A TYPE WITH RIBBON CABLE FOR CONNECTION TO THE MODULE DEVELOPMENT BOARD	6	FIGURE 12: PICTURE OF THE MODULE DEVELOPMENT BOARD SHOWING THE BATTERY CONNECTION POINTS AND BUTTONS.....	11

List of Tables

TABLE 1: POSSIBLE SOURCES OF POWER FOR THE MODULE DEVELOPMENT BOARD	5
TABLE 2: CONNECTIONS BETWEEN RASPBERRY PI AND DWM1001 MODULE	7
TABLE 3: THE FIRMWARE INDICATION LEDS	9
TABLE 4: A LIST OF SOLDER JUMPERS AVAILABLE ON THE MODULE DEVELOPMENT BOARD	12
TABLE 5: DOCUMENT HISTORY.....	14

DOCUMENT INFORMATION

Disclaimer

Decawave reserves the right to change product specifications without notice. As far as possible changes to functionality and specifications will be issued in product specific errata sheets or in new versions of this document. Customers are advised to check with Decawave for the most recent updates on this product.

The DWM1001 module mounted on the DWM1001-DEV PCB is pre-loaded with firmware, please refer to the "DWM1001 Firmware User Guide" for disclaimer and license terms.

Copyright © 2017 Decawave Ltd

LIFE SUPPORT POLICY

Decawave products are not authorized for use in safety-critical applications (such as life support) where a failure of the Decawave product would reasonably be expected to cause severe personal injury or death. Decawave customers using or selling Decawave products in such a manner do so entirely at their own risk and agree to fully indemnify Decawave and its representatives against any damages arising out of the use of Decawave products in such safety-critical applications.



Caution! ESD sensitive device. Precaution should be used when handling the device in order to prevent permanent damage.

REGULATORY APPROVALS

The DWM1001, as supplied from Decawave, has not been certified for use in any particular geographic region by the appropriate regulatory body governing radio emissions in that region although it is capable of such certification depending on the region and the manner in which it is used.

All products developed by the user incorporating the DWM1001 must be approved by the relevant authority governing radio emissions in any given jurisdiction prior to the marketing or sale of such products in that jurisdiction and user bears all responsibility for obtaining such approval as needed from the appropriate authorities.

1 OVERVIEW

This document gives technical details of the DWM1001 module development board, called the DWM1001-DEV. All the functions of the DWM1001 module can be exercised with this board. Figure 1 gives an overview of the main components of the module development board.

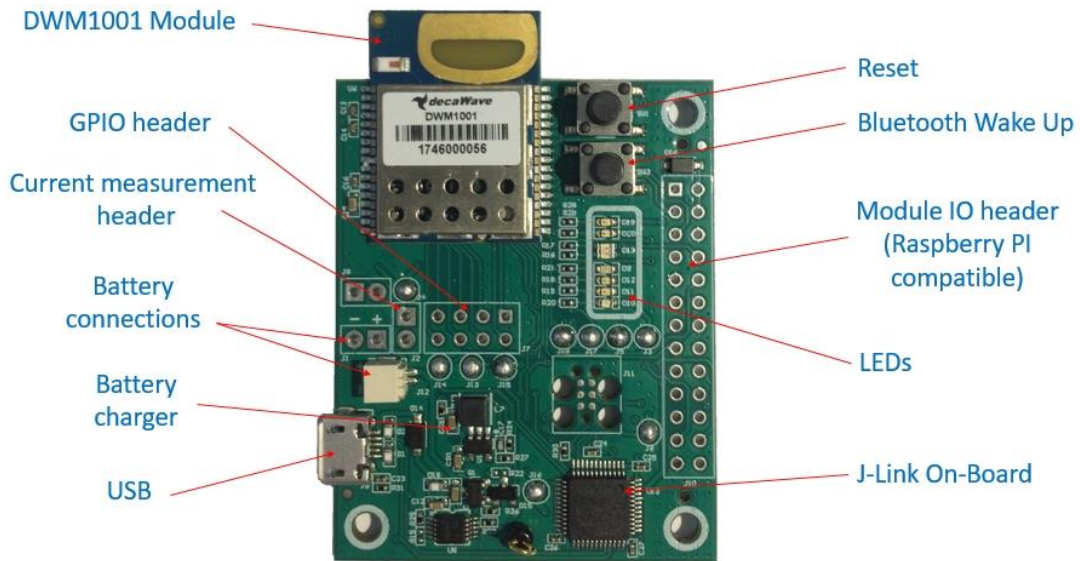
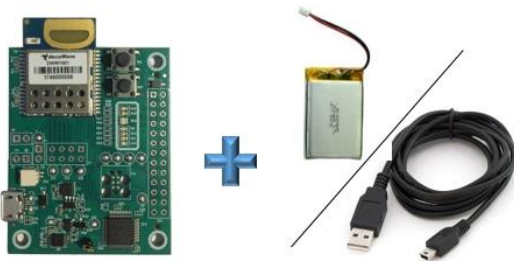

Figure 1 The main components of the module development board are shown

The module development board can be used to create an Anchor or a Tag for an RTLS system. This is shown in Figure 2. It can also be combined with a Raspberry Pi to create a gateway device. Figure 3 shows the configuration of an RTLS system where the module development board can be an Anchor, Tag or Gateway device.

Build an Anchor or a Tag



Build a Gateway

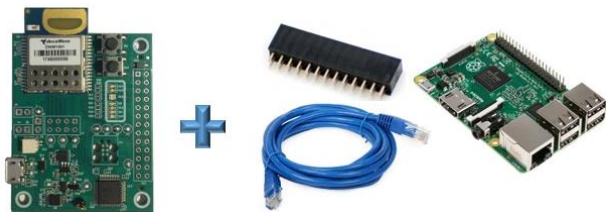

Figure 2: The module development board can be used to create an Anchor, a Tag or a Gateway

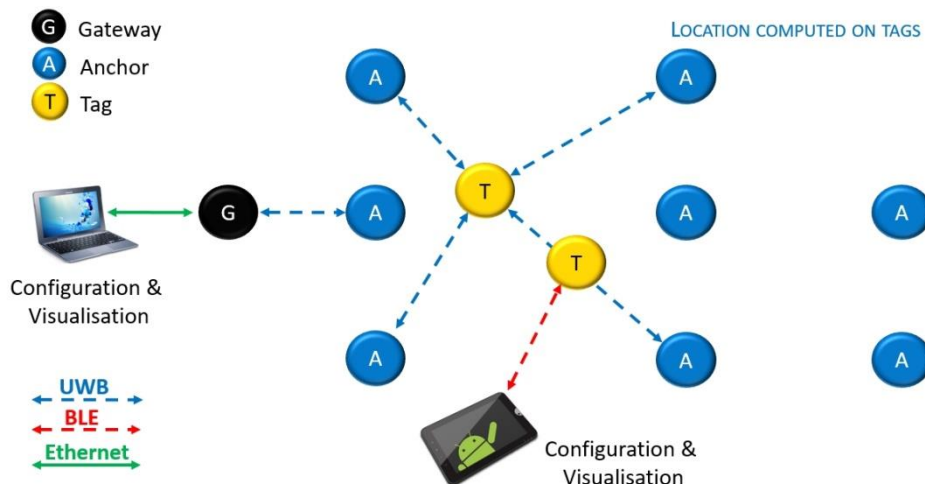

Figure 3: Module development board used as an Anchor, Tag or Gateway device, in an RTLS system

1.1 Suitable Power Supply Options

The module development board has a voltage supply requirement of 3.6V to 5.5V. The module development board can be powered from three different sources. Details are given in Table 1.

Table 1: Possible sources of power for the module development board

Power Source	Voltage level	Current level (Recommended)	Notes
USB Connection	+5V	500mA	The board requires a connection to a high power USB connection. Check that it can supply at least 500mA.
Battery	3.6V - 5.5V	500mA	Any battery that meets the 3.6V to 5.5V voltage supply will suffice.
Raspberry Pi Power	+5V	500mA	

1.2 Block Diagram of the development board

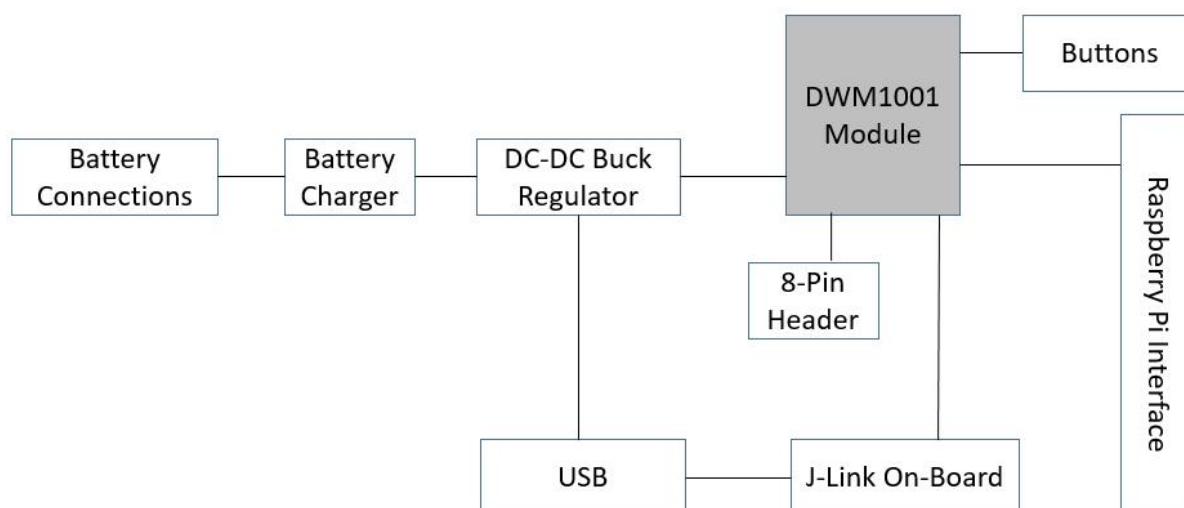

Figure 4: The main sections of the DWM1001 Module Development Board

Figure 4 shows the main sections of the Module Development Board. A brief overview of these sections is given below with further details given in later sections of this document.

The DWM1001 module is based on Decawave's DW1000 Ultra Wideband (UWB) transceiver IC, which is an IEEE 802.15.4-2011 UWB implementation. It integrates UWB and Bluetooth antenna, all RF circuitry, Nordic Semiconductor nRF52832 and motion sensor [1].

The USB connection can provide power to the Module Development Board and also allows for the capability to flash the DWM1001 module and furthermore to debug software running on the DWM1001 module.

The Power Supply takes its input from USB or from a Battery or from a connected Raspberry Pi. It powers the module and the other devices on the Module Development Board. It can also charge a connected battery when powered by USB or the Raspberry Pi.

Two buttons and a number of LEDs are provided for end user applications. A header to interface to the Raspberry Pi is also provided.

2 DWM1001 MODULE

Figure 5 shows a block diagram of the module. All major sections of the module are shown, along with the source of signals coming to the module's pins.

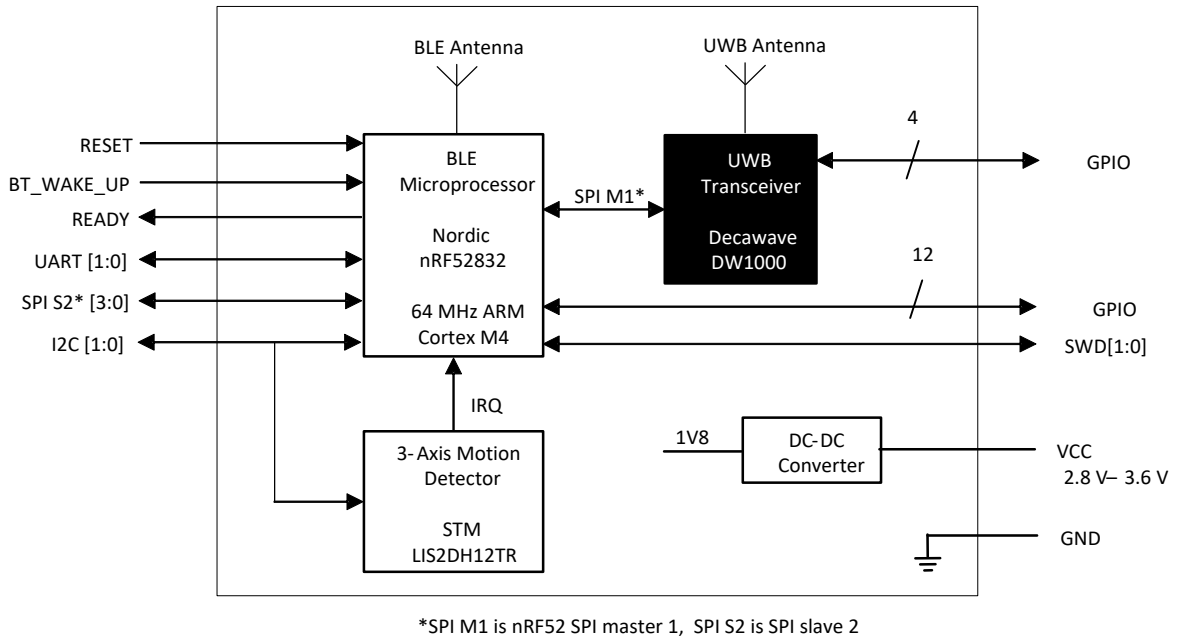

Figure 5: Block diagram of DWM1001 module

3 RASPBERRY PI INTERFACE

3.1 Means of connection

There are a number of types of Raspberry Pi. The preferred options are the A and B variants. To use the A variant you will require a ribbon cable to connect to the Module Development Board. Figure 6 below shows a Raspberry Pi Model A with the ribbon cable connected.

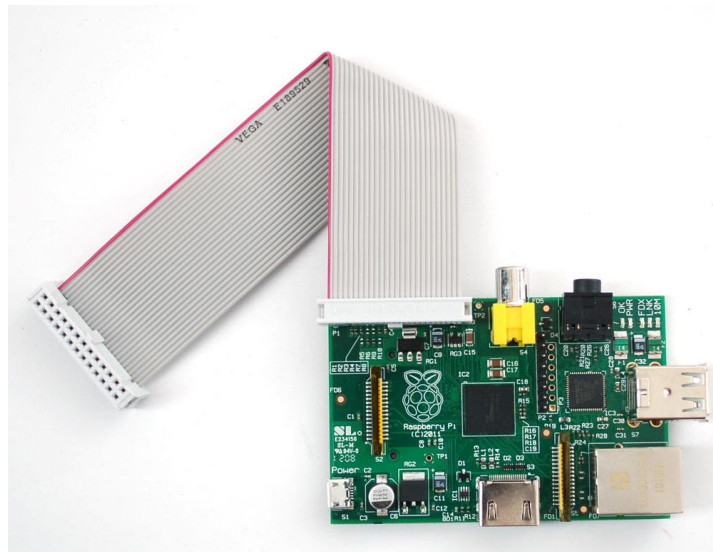

Figure 6: Raspberry Pi Model A Type with ribbon cable for connection to the Module Development Board

As an alternative to the ribbon cable it is possible to get header connectors with extra long pins. Such a connector is shown in Figure 7. One supplier of these connectors is <https://www.modmypi.com>. Search for part number MMP-0275.

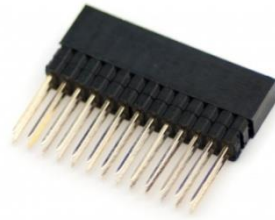

Figure 7: Header connector with extended pin lengths

DWM1001 Module Pin to Raspberry Pi Connector Mapping Table 2 below gives the connection details between the Raspberry Pi connector and the DWM1001 module. See the DWM1001 datasheet[1] and the schematic for the DWM1001 Module Development Board at the end of this document.

Table 2: Connections between Raspberry Pi and DWM1001 module

Module Development Board RPi connector		Module Pin Number (and Name) from DWM1001 Module Data Sheet
Pin Number	Schematic Net Name	
3	SDA_RPI	Pin 23 (GPIO_15)
5	SCL_RPI	Pin 25 (GPIO_8)
9	GND	GND
15	GPIO_RPI	Pin 19 (READY)
19	SPI1_MOSI	Pin 27 (SPIS_MOSI)
21	SPI1_MISO	Pin 26 (SPIS_MISO)
23	SPI1_CLK	Pin 25 (GPIO_8)
25	GND	GND
2	VRPI	Provides input power to Module Development Board. (Not connected directly to module)
4	VRPI	
6	GND	
8	TXD	Pin 18 (UART_RX)
10	RXD_RPI/RXD	Pin 20 (UART_TX)
12	RESET	Pin 33 (RESETn)
14	GND	GND
20	GND	GND
24	CS_RPI	Pin29 (SPIS_CSn)

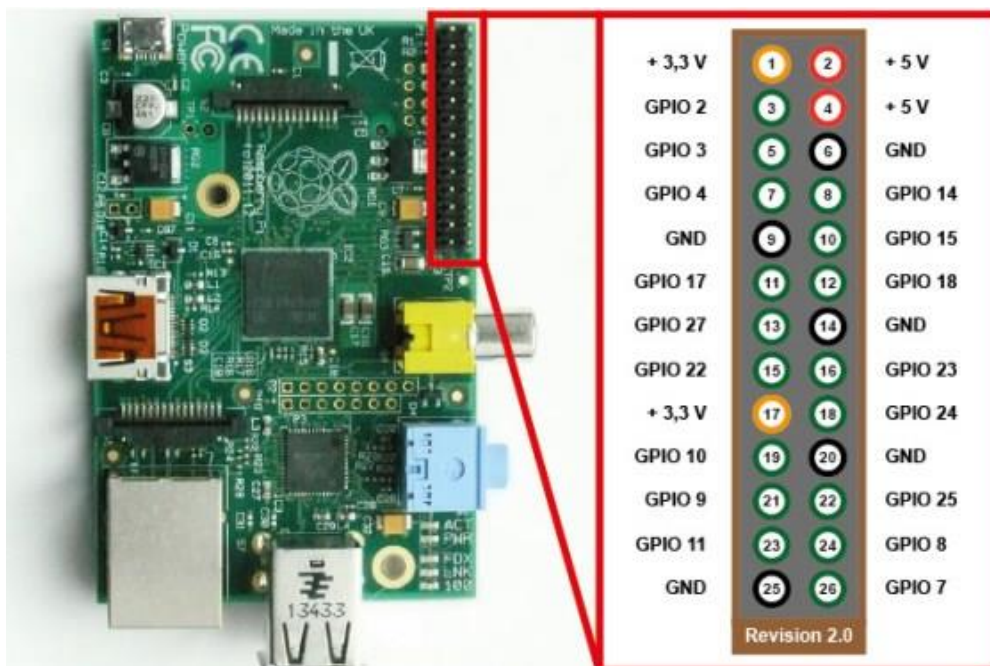

Figure 8: Pin designations of the Raspberry Pi Model A variant.

Figure 8 shows the pin designations for the model A Raspberry Pi variant. The Raspberry Pi Model B variant has a larger header connector with 40 pins. Figure 9 below shows its header and connector pin designations.

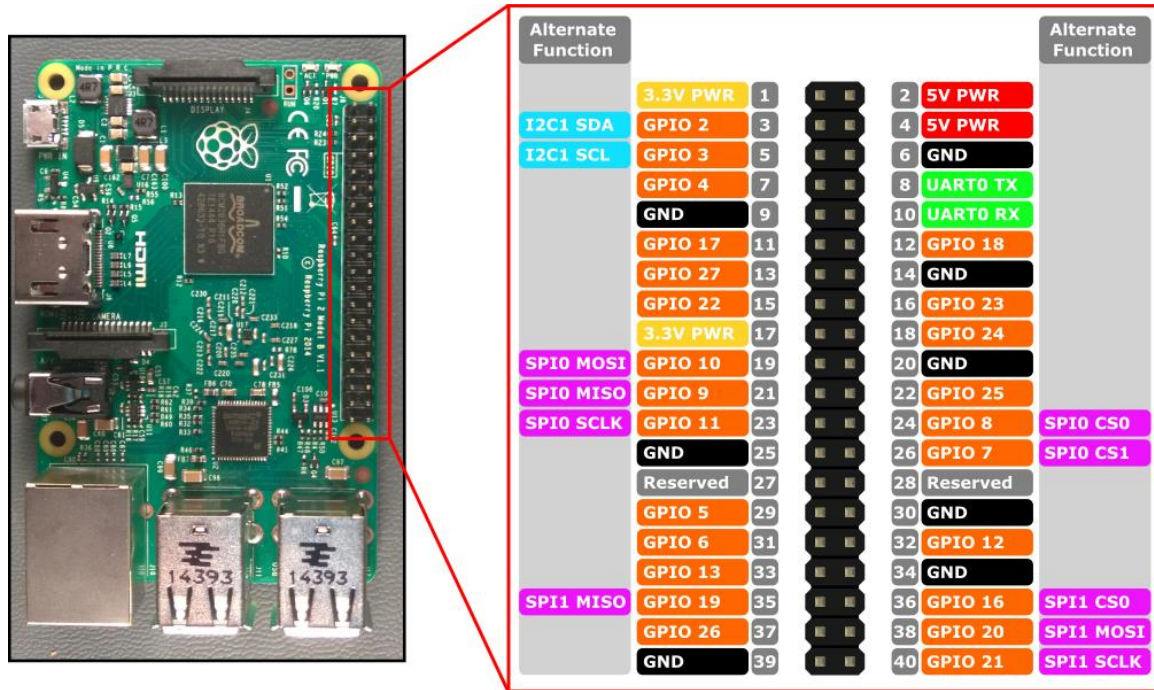

Figure 9: Pin designations of the Raspberry Pi Model B variant.

4 THE DEVELOPMENT BOARD LEDs

The Development board has a number of LEDs for indication purposes. They give useful indication of a number of events within the system. Figure 10 shows the LEDs and their use with the pre programmed firmware. Table 3 gives further specific details on D9, D10 and D11.



Figure 10: Front View of the DWM1001-DEV Module Development Board

Note (1): See DW1000 IC User Manual for description of D13 TX/RX LEDs

Note (2): F/W function of LEDs D9, D11, D10 is shown in the table below

Table 3: The Firmware Indication LEDs

GREEN D9	RED D11	BLUE D10	Function	Description
Blink Fast	Blink Fast	Blink Fast	Bootloader Active	LEDs blink twice
Blink Fast	Blink Fast	Blink Fast	Firmware Update in Progress	LEDs alternate between Blue and Green/Red
On	On		Mode Status	UWB Passive Mode
On	On			UWB Off Mode
Blink Fast	Blink Fast			Anchor Node (no UWB signal detected for more than 8 s)
Blink Slow	Blink Slow			Tag Node (no UWB signal detected for more than 8 s)
On				Tag Low Power Mode: ON
Off				Tag Low Power Mode: SLEEP
On			MAC Status	Connected anchor or tag
Blink Slow				Connected anchor initiator
Blink Fast				UWB communication detected
Off				Low Power node: no signal detected for more than 6 s
-		On	Bluetooth Status	Bluetooth Connected
-		Off		Bluetooth Disconnected
-	On		Data / Measurement Status	UWB TX/RX Active
-	Off			Idle

5 ON BOARD JLINK

The processor on the Module Development Board provides USB to SWD (Serial Wire Debug) conversion to allow programming and debug of software on the DWM1001 module. Figure 11 below shows the relevant sections on the Module Development Board.

Serial Wire Debug is a replacement for the more traditional 5-pin JTAG port. It uses a clock (SWDCLK) and a Single bi-directional data pin (SWDIO), providing all the normal JTAG debug and test functionality. SWDIO and SWCLK are overlaid on the TMS and TCK pins. In order to communicate with a SWD device, J-Link sends out data on SWDIO, synchronous to the SWCLK. With every rising edge of SWCLK, one bit of data is transmitted or received on the SWDIO. The data read from SWDIO can then be retrieved from the input buffer.

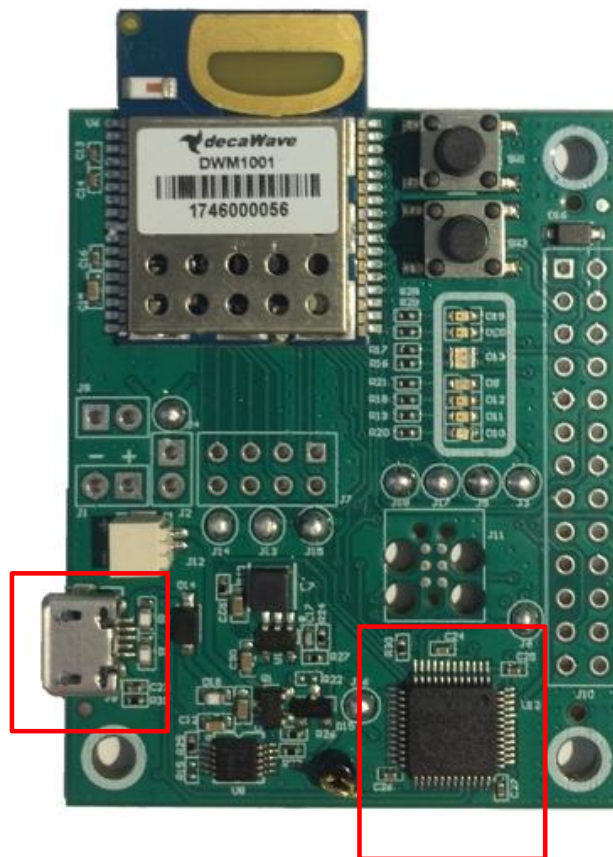

Figure 11: Module Development Board JLink components

6 POWER SUPPLY AND BATTERY CONNECTIONS

The Power Supply takes its input from USB or from a Battery or from a connected Raspberry Pi. It powers the module and the other devices on the Module Development Board. It can also charge a connected battery when powered by USB or the Raspberry Pi.

The Battery Charger is a Lithium - Ion battery charger. Batteries can be connected to the module development board at the connectors shown in Figure 12.

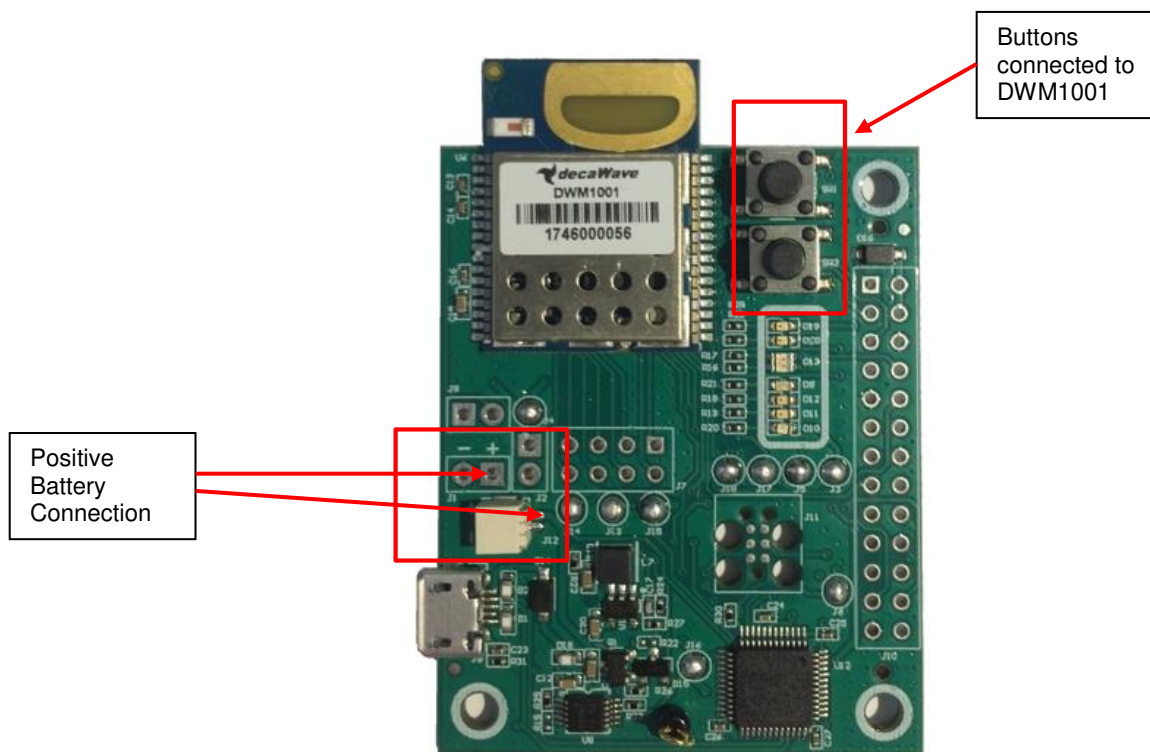

Figure 12: Picture of the module development board showing the battery connection points and buttons

7 BUTTONS SW1 AND SW2

There are two buttons on the PCB, SW1 and SW2. SW1 is connected to the RESETn pin on the DWM1001 module and SW2 is connected to the BT_WAKE_UP pin on the DWM1001 module. SW2 wakes up the Bluetooth functionality when a tag is in low-power mode, as described in the System Overview document[3]. Buttons are shown above in Figure 12.

8 DEVELOPMENT BOARD SOLDER BRIDGE JUMPERS

The Module Development Board has eight solder bridge jumpers. These can be used to allow evaluation of different aspects of the DWM1001 modules performance. For example Solder Bridge J4 can be desoldered and a resistor placed across connector J2 to allow measurement of the modules current consumption. Table 4 gives a list of these jumpers, their purpose and the state they are in when leaving the factory. Investigation of the schematic of the Module Development board at the end of this document will give further details on their use.

Table 4: A list of solder jumpers available on the Module Development Board

Jumper Number	Purpose	Default State
J3	Desolder to disconnect user LEDs from the module	Closed
J5	Desolder to disconnect Tx and Rx LEDs from the module	Closed
J4	Desolder to measure module current in J2	Closed
J6	Desolder to disconnect Reset button from JLINK	Closed
J13	Solder to connect UART Rx between Module and Raspberry Pi	Closed
J14	Desolder to disconnect module RXD from JLINK	Closed
J15	Desolder to disconnect module TXD from JLINK	Closed
J16	Desolder to disconnect power to JLINK	Closed

9 DEVELOPMENT BOARD SCHEMATIC

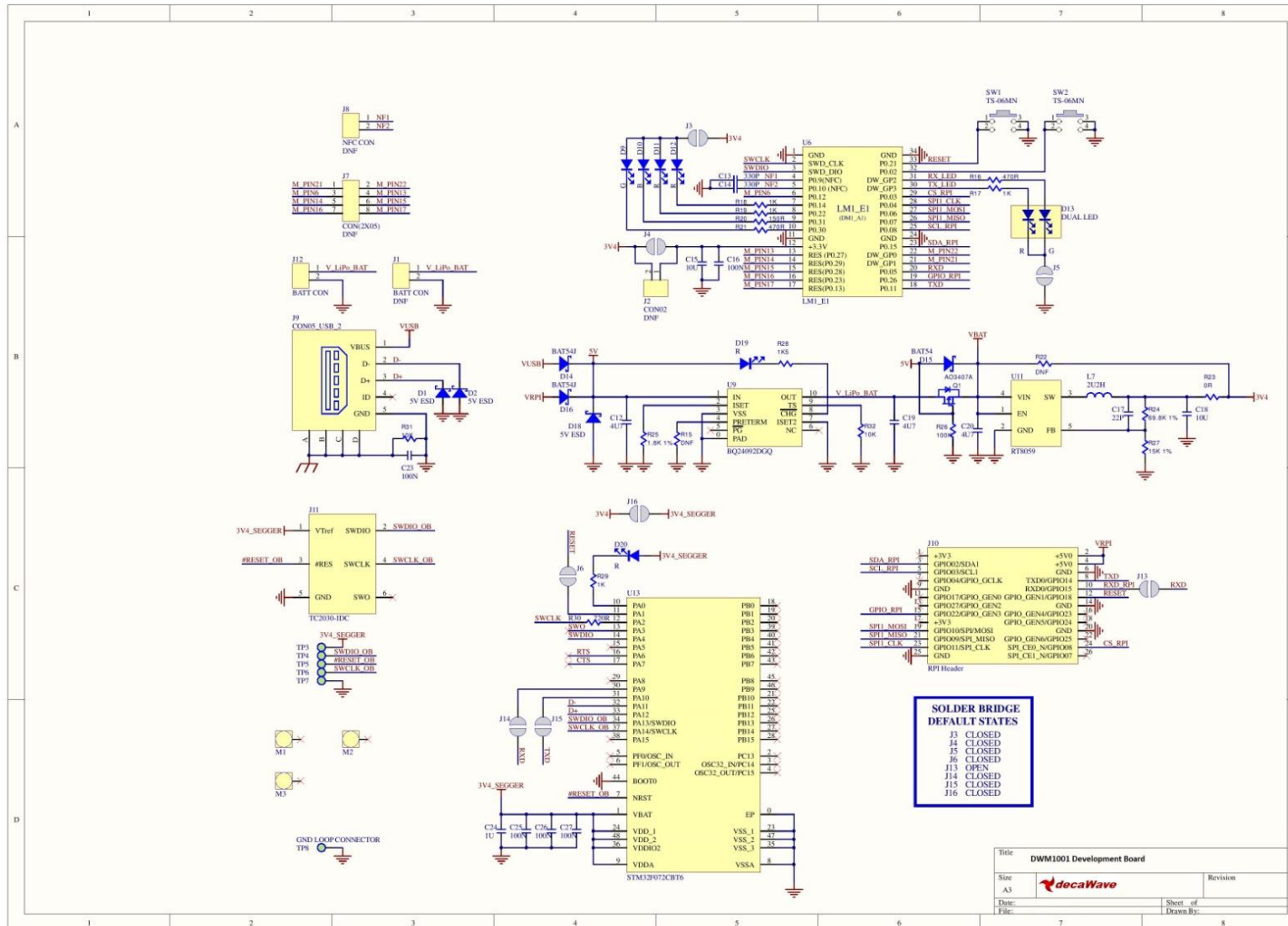

10 REFERENCES

- [1] Decawave DWM1001 Datasheet www.decawave.com
- [2] IEEE802.15.4-2011 or “IEEE Std 802.15.4™-2011” (Revision of IEEE Std 802.15.4-2006). IEEE Standard for Local and metropolitan area networks – Part 15.4: Low-Rate Wireless Personal Area Networks (LR-WPANs). IEEE Computer Society Sponsored by the LAN/MAN Standards Committee. Available from <http://standards.ieee.org/>
- [3] DWM1001 System Overview

11 DOCUMENT HISTORY

Table 5: Document History

Revision	Date	Description
1.0	20/12/17	First Version

12 MAJOR CHANGES

To be completed when document is updated.

13 ABOUT DECAWAVE

Decawave is a pioneering fabless semiconductor company whose flagship product, the DW1000, is a complete, single chip CMOS Ultra-Wideband IC based on the IEEE 802.15.4-2011[2] UWB standard. This device is the first in a family of parts that will operate at data rates of 110 kbps, 850 kbps, 6.8 Mbps.

The resulting silicon has a wide range of standards-based applications for both Real Time Location Systems (RTLS) and Ultra Low Power Wireless Transceivers in areas as diverse as manufacturing, healthcare, lighting, security, transport, inventory & supply chain management.

Further Information

For further information on this or any other Decawave product contact a sales representative as follows: -

Decawave Ltd
Adelaide Chambers
Peter Street
Dublin
D08 T6YA
Ireland
+353 1 6975030
e: sales@decawave.com
w: www.decawave.com