



Chipsmall Limited consists of a professional team with an average of over 10 year of expertise in the distribution of electronic components. Based in Hongkong, we have already established firm and mutual-benefit business relationships with customers from,Europe,America and south Asia,supplying obsolete and hard-to-find components to meet their specific needs.

With the principle of “Quality Parts,Customers Priority,Honest Operation,and Considerate Service”,our business mainly focus on the distribution of electronic components. Line cards we deal with include Microchip,ALPS,ROHM,Xilinx,Pulse,ON,Everlight and Freescale. Main products comprise IC,Modules,Potentiometer,IC Socket,Relay,Connector.Our parts cover such applications as commercial,industrial, and automotives areas.

We are looking forward to setting up business relationship with you and hope to provide you with the best service and solution. Let us make a better world for our industry!



Contact us

Tel: +86-755-8981 8866 Fax: +86-755-8427 6832

Email & Skype: info@chipsmall.com Web: www.chipsmall.com

Address: A1208, Overseas Decoration Building, #122 Zhenhua RD., Futian, Shenzhen, China



Digitally controlled audio processor

Features

- Input multiplexer
 - Two stereo and one mono inputs
 - One quasi differential input
 - Selectable input gain for optimal adaptation to different sources
- Fully programmable loudness function
- Volume control in 0.3dB steps including gain up to 20dB
- Zero crossing mute, soft mute and direct mute
- Bass and treble control
- Four speaker attenuators
 - Four independent speakers control in 1.25dB steps for balance and fader facilities
 - Independent mute function
- All functions programmable via serial I²C bus

Description

The audioprocessor TDA7342 is an upgrade of the TDA731X audioprocessor family.

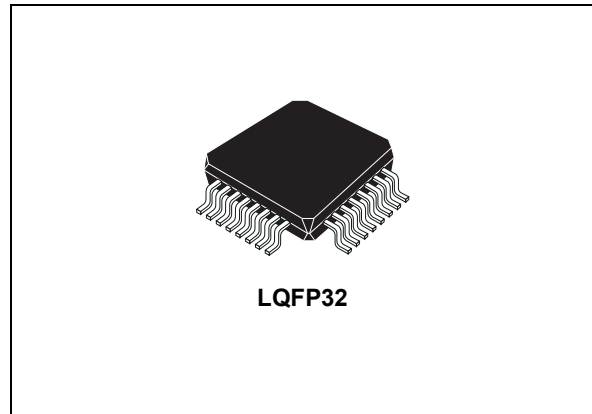

Due to a highly linear signal processing, using CMOS-switching techniques instead of standard bipolar multipliers, very low distortion and very low noise are obtained. Several new features like softmute, and zero-crossing mute are implemented. The soft Mute function can be activated in two ways:

1. Via serial bus (Mute byte, bit D0)
2. Directly on pin 21 through an I/O line of the microcontroller

Very low DC stepping is obtained by use of a BICMOS technology.

Order codes

Part number	Package	Packing
TDA7342	LQFP32	Tray
TDA7342TR	LQFP32	Tape and reel

Contents

1	Block diagram and pin description	5
1.1	Block diagram	5
1.2	Pin description	5
2	Electrical specifications	6
2.1	Absolute maximum ratings	6
2.2	Quick reference data	6
2.3	Thermal data	6
2.4	Electrical characteristics	7
3	I2C bus interface	10
3.1	Data Validity	10
3.2	Start and Stop Conditions	10
3.3	Byte Format	10
3.4	Acknowledge	10
3.5	Transmission without Acknowledge	10
4	Software specification	12
4.1	Interface Protocol	12
4.2	Auto increment	12
4.3	Transmitted data	13
4.4	Data byte specification	13
5	Package information	18
6	Revision history	19

List of tables

Table 1.	Absolute Maximum Ratings	6
Table 2.	Quick reference data	6
Table 3.	Thermal data	6
Table 4.	Electrical characteristics	7
Table 5.	Subaddress (receive mode)	12
Table 6.	Send mode	13
Table 7.	Input selector	13
Table 8.	Loudness	14
Table 9.	Mute	14
Table 10.	Speaker attenuators (LF, LR, RF, RR)	15
Table 11.	Bass/Treble	15
Table 12.	Volume	17
Table 13.	Document revision history	19

List of figures

Figure 1.	Block diagram	5
Figure 2.	Pin connection (top view)	5
Figure 3.	Data Validity on the I2C BUS	11
Figure 4.	Timing Diagram of I2C BUS	11
Figure 5.	Acknowledge on the I2C BUS	11
Figure 6.	Interface protocol	12
Figure 7.	LQFP32 Mechanical Data & Package Dimensions	18

1 Block diagram and pin description

1.1 Block diagram

Figure 1. Block diagram

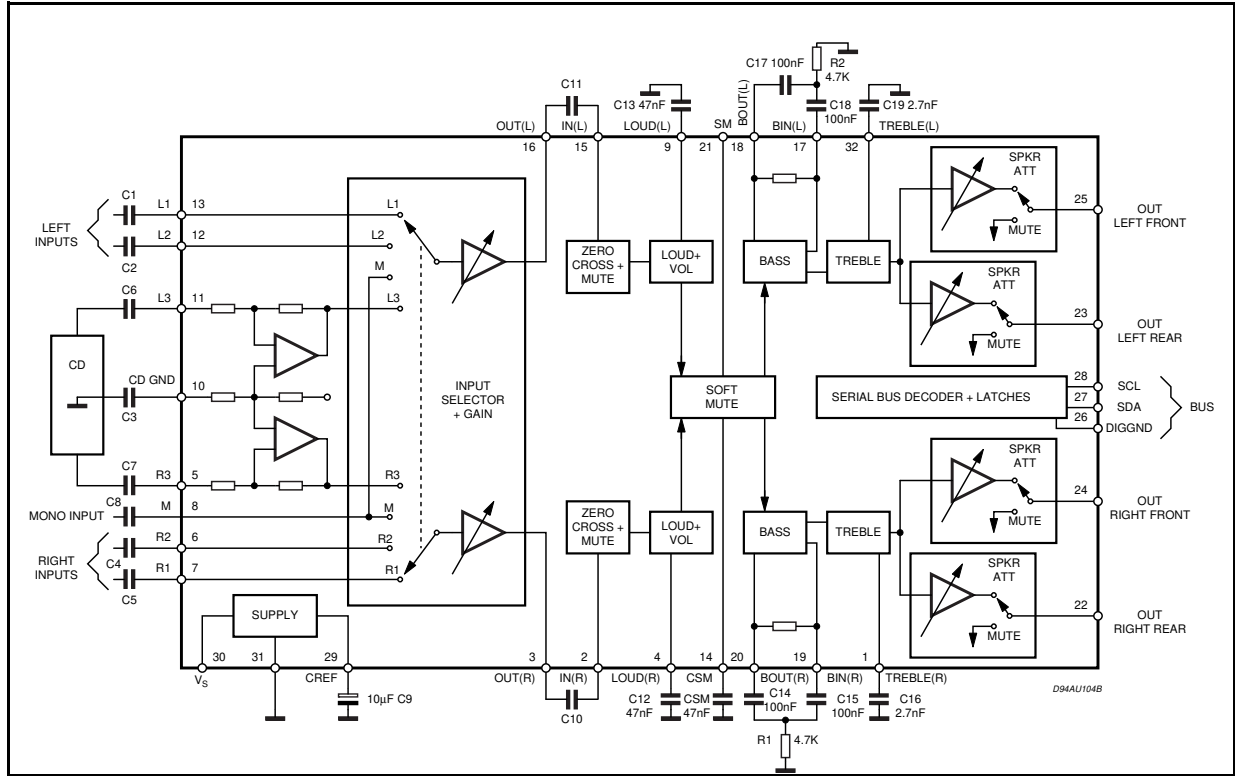

1.2 Pin description

Figure 2. Pin connection (top view)

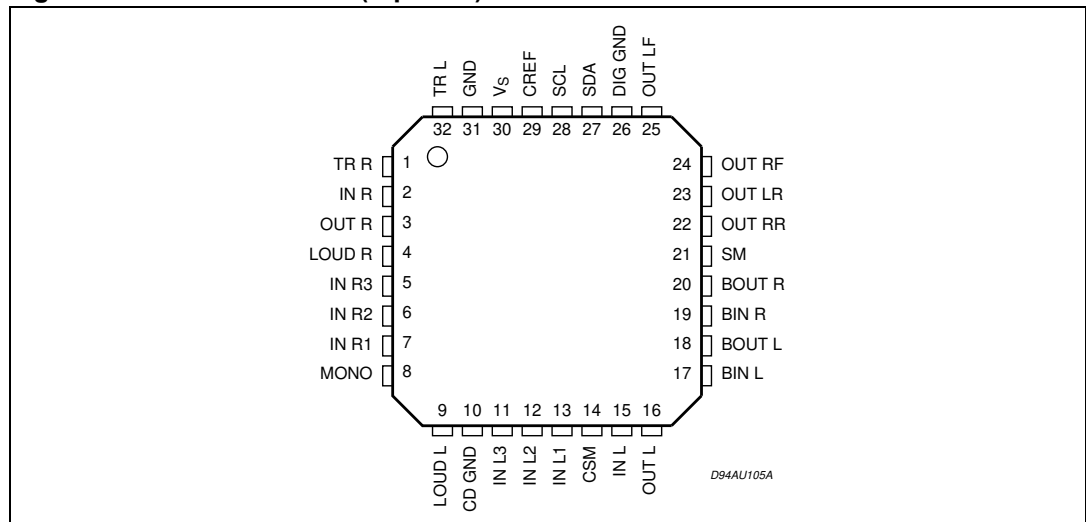

2 Electrical specifications

2.1 Absolute maximum ratings

Table 1. Absolute Maximum Ratings

Symbol	Parameter	Value	Unit
V _S	Operating supply voltage	10.5	V
T _{amb}	Operating ambient temperature	-40 to 85	°C
T _{stg}	Storage temperature range	-55 to 150	°C

2.2 Quick reference data

Table 2. Quick reference data

Symbol	Parameter	Min.	Typ.	Max.	Unit
V _S	Supply voltage	6	9	10.2	V
V _{CL}	Max. input signal handling	2.1	2.6		V _{rms}
THD	Total harmonic distortion V = 1V _{rms} f = 1KHz		0.01	0.08	%
S/N	Signal to noise ratio		106		dB
S _C	Channel separation		100		dB
	Volume control 0.3dB step	-59.7		20	dB
	Treble control 2dB step	-14		+14	dB
	Bass control 2dB step	-10		+18	dB
	Fader and balance control 1.25dB step	-38.75		0	dB
	Input gain 3.75dB step	0		11.25	dB
	Mute attenuation		100		dB

2.3 Thermal data

Table 3. Thermal data

Symbol	Parameter	Value	Unit
R _{th j-amb}	Thermal resistance junction to pins	150	°C/W

2.4 Electrical characteristics

Table 4. Electrical characteristics

($V_S = 9V$; $R_L = 10K\Omega$; $R_g = 50\Omega$; $T_{amb} = 25^\circ C$; all gains = 0dB; $f = 1KHz$. Refer to the test circuit, unless otherwise specified.)

Symbol	Parameter	Test condition	Min.	Typ.	Max.	Unit
Input selector						
R_I	Input resistance		70	100	130	$K\Omega$
V_{CL}	Clipping level	$d \leq 0.3\%$	2.1	2.6		V_{RMS}
S_I	Input separation		80	100		dB
R_L	Output load resistance		2			$K\Omega$
$G_{I\ MIN}$	Minimum input gain		-0.75	0	0.75	dB
$G_{I\ MAX}$	Maximum input gain		10.25	11.25	12.25	dB
G_{step}	Step resolution		2.75	3.75	4.75	dB
e_N	Input noise	20Hz to 20 KHz unweighted		2.3		μV
V_{DC}	DC steps	Adiacent Gain Steps		1.5	10	mV
		G_{IIN} to G_{IMAX}		3		mV
Differential input (IN 3)						
R_I	Input resistance	Input selector BIT D6 = 0 (0dB)	10	15	20	$K\Omega$
		Input selector BIT D6 = 1(-6dB)	14	20	30	$K\Omega$
CMRR	Common mode rejection ratio	$V_{CM} = 1V_{RMS}$; $f = 1KHz$	48	75		dB
		$f = 10KHz$	45	70		dB
d	Distortion	$V_I = 1V_{RMS}$		0.01	0.08	%
e_{IN}	Input noise	20Hz to 20KHz; Flat; D6 = 0		5		μV
G_{DIFF}	Differential gain	D6 = 0	-1	0	1	dB
		D6 = 1	-7	-6	-5	dB
Volume control						
R_I	Input resistance		35	50		$K\Omega$
G_{MAX}	Maximum gain		18.75	20	21.25	dB
A_{MAX}	Maximum attenuation		57.7	59.7	62.7	dB
A_{STEPC}	Step resolution coarse atten.		0.5	1.25	2.0	dB
A_{STEPF}	Step resolution fine attenuation		0.11	0.31	0.51	dB
E_A	Attenuation set error	$G = 20$ to $-20dB$	-1.25	0	1.25	dB
		$G = -20$ to $-58dB$	-3		2	dB
E_t	Tracking error			2		dB
V_{DC}	DC steps	Adiacent Attenuation Steps	-3	0	3	mV
		From 0dB to A_{MAX}		0.5	5	mV

Table 4. Electrical characteristics (continued)

($V_S = 9V$; $R_L = 10K\Omega$; $R_g = 50\Omega$; $T_{amb} = 25^\circ C$; all gains = 0dB; $f = 1KHz$. Refer to the test circuit, unless otherwise specified.)

Symbol	Parameter	Test condition	Min.	Typ.	Max.	Unit
Loudness control						
R_I	Internal resistor	Loud = On	35	50	65	$K\Omega$
A_{MAX}	Maximum attenuation		17.5	18.75	20.0	dB
A_{step}	Step resolution		0.5	1.25	2.0	dB
Zero crossing mute						
V_{TH}	Zero crossing threshold ⁽¹⁾	WIN = 11		20		mV
		WIN = 10		40		mV
		WIN = 01		80		mV
		WIN = 00		160		mV
A_{MUTE}	Mute attenuation		80	100		dB
V_{DC}	DC step	0dB to Mute		0	3	mV
Soft mute						
A_{MUTE}	Mute attenuation		45	60		dB
T_{DON}	On delay time	$C_{CSM} = 22nF$; 0 to -20dB; $I = I_{MAX}$	0.7	1	1.7	ms
		$C_{CSM} = 22nF$; 0 to -20dB; $I = I_{MIN}$	20	35	55	ms
I_{DOFF}	Off current	$V_{CSM} = 0V$; $I = I_{MAX}$	25	50	75	μA
		$V_{CSM} = 0V$; $I = I_{MIN}$		1		μA
V_{THSM}	Soft mute threshold (pin 14)		1.5	2.5	3.5	V
R_{INT}	Pull-up resistor (pin 21)	⁽²⁾	35	50	65	$k\Omega$
V_{SMH}	(pin 21) level high		3.5			V
V_{SML}	(pin 21) level low	Soft mute active			1	V
Bass control						
B_{BOOST}	Max bass boost		15	18	20	dB
B_{CUT}	Max bass cut		-8.5	-10	-11.5	dB
A_{step}	Step resolution		1	2	3	dB
R_g	Internal feedback resistance		45	65	85	$K\Omega$
Treble control						
C_{RANGE}	Control range		± 13	± 14	± 15	dB
A_{step}	Step resolution		1	2	3	dB
Speaker attenuators						
C_{RANGE}	Control range		35	37.5	40	dB
A_{step}	Step resolution		0.5	1.25	2.00	dB

Table 4. Electrical characteristics (continued)

($V_S = 9V$; $R_L = 10K\Omega$; $R_g = 50\Omega$; $T_{amb} = 25^\circ C$; all gains = 0dB; $f = 1KHz$. Refer to the test circuit, unless otherwise specified.)

Symbol	Parameter	Test condition	Min.	Typ.	Max.	Unit
A_{MUTE}	Output mute attenuation	Data word = XXX11111	80	100		dB
E_A	Attenuation set error				1.25	dB
V_{DC}	DC steps	Adjacent attenuation steps		0	3	mV
Audio output						
V_{clip}	Clipping level	$d = 0.3\%$	2.1	2.6		Vrms
R_L	Output load resistance		2			$K\Omega$
R_O	Output impedance			30	100	Ω
V_{DC}	DC voltage Level		3.5	3.8	4.1	V
General						
V_{CC}	Supply voltage		6	9	10.2	V
I_{CC}	Supply current		5	10	15	mA
PSRR	Power supply rejection ratio	$f = 1KHz$	60	80		dB
		$B = 20$ to 20kHz "A" weighted		65		dB
e_{NO}	Output noise	Output Muted ($B = 20$ to 20kHz flat)		2.5		μV
		All Gains 0dB ($B = 20$ to 20kHz flat)		5	15	μV
E_t	Total tracking error	$A_V = 0$ to -20dB		0	1	dB
		$A_V = -20$ to -60dB		0	2	dB
S/N	Signal to noise ratio	All Gains = 0dB; $V_O = 1V_{rms}$		106		dB
S_C	Channel separation		80	100		dB
d	Distortion	$V_{IN} = 1V$		0.01	0.08	%
Bus inputs						
V_{IL}	Input low voltage				1	V
V_{IN}	Input high voltage		3			V
I_{IN}	Input current	$V_{IN} = 0.4V$	-5		5	μA
V_O	Output voltage SDA acknowledge	$I_O = 1.6mA$		0.4	0.8	V

1. WIN represents the MUTE programming bit pair D6, D5 for the zero crossing window threshold.
2. Internal pull-up resistor to $V_S/2$; LOW = softmute active.

3 I²C bus interface

Data transmission from microprocessor to the TDA7342 and viceversa takes place thru the 2 wires I²C BUS interface, consisting of the two lines SDA and SCL (pull-up resistors to positive supply voltage must be externally connected).

3.1 Data Validity

As shown in [Figure 3](#), the data on the SDA line must be stable during the high period of the clock. The HIGH and LOW state of the data line can only change when the clock signal on the SCL line is LOW.

3.2 Start and Stop Conditions

As shown in [Figure 5](#) a start condition is a HIGH to LOW transition of the SDA line while SCL is HIGH. The stop condition is a LOW to HIGH transition of the SDA line while SCL is HIGH.

A STOP conditions must be sent before each START condition.

3.3 Byte Format

Every byte transferred to the SDA line must contain 8 bits. Each byte must be followed by an acknowledge bit. The MSB is transferred first.

3.4 Acknowledge

The master (μ P) puts a resistive HIGH level on the SDA line during the acknowledge clock pulse (see [Figure 5](#)). The peripheral (audioprocessor) that acknowledges has to pull-down (LOW) the SDA line during the acknowledge clock pulse, so that the SDA line is stable LOW during this clock pulse.

The audioprocessor which has been addressed has to generate an acknowledge after the reception of each byte, otherwise the SDA line remains at the HIGH level during the ninth clock pulse time. In this case the master transmitter can generate the STOP information in order to abort the transfer.

3.5 Transmission without Acknowledge

Avoiding to detect the acknowledge of the audioprocessor, the μ P can use a simpler transmission: simply it waits one clock without checking the slave acknowledging, and sends the new data. This approach of course is less protected from misworking and decreases the noise immunity.

Figure 3. Data Validity on the I²C BUS

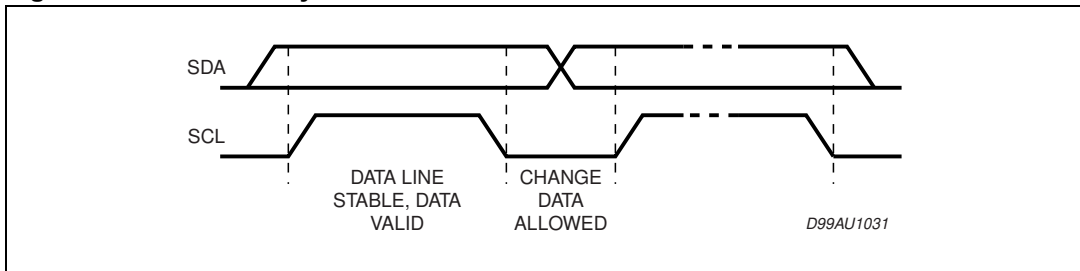

Figure 4. Timing Diagram of I²C BUS

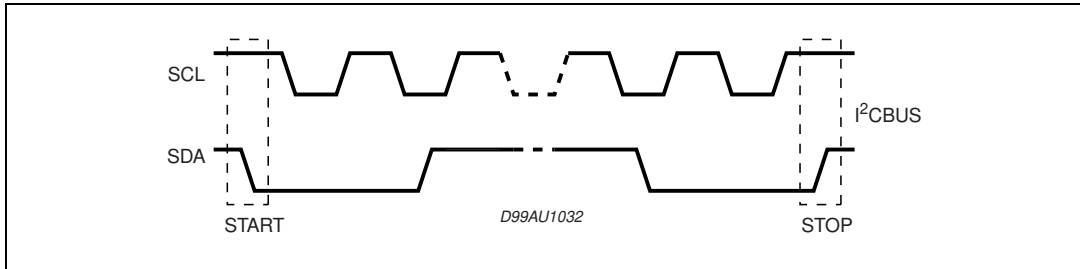
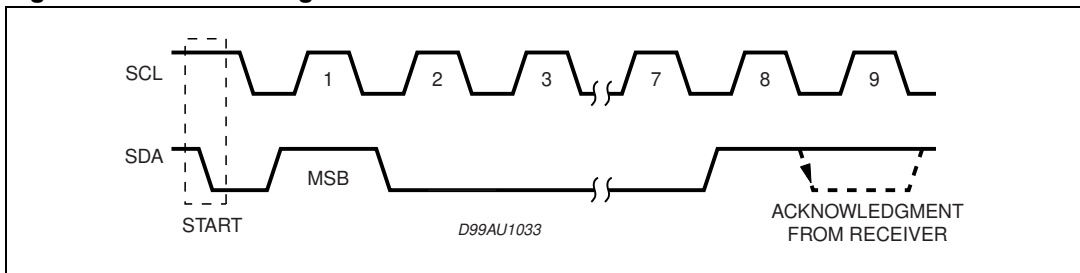

Figure 5. Acknowledge on the I²C BUS



Patent note: Purchase of I²C Components of STMicroelectronics, conveys a license under the Philips I²C Patent Rights to use these components in an I²C system, provided that the system conforms to the I²C Standard Specifications as defined by Philips.

4 Software specification

4.1 Interface Protocol

The interface protocol comprises:

- ? A start condition (S)
- ? A chip address byte, (the LSB bit determines read/write transmission)
- ? A subaddress byte.
- ? A sequence of data (N-bytes + acknowledge)
- ? A stop condition (P)

Figure 6. Interface protocol

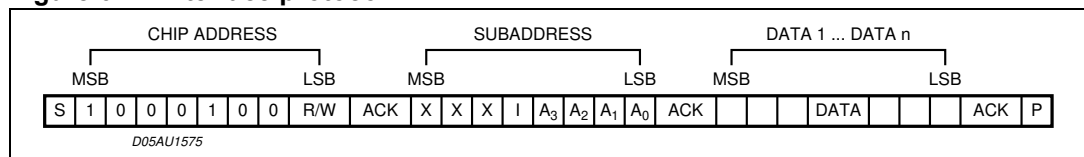

ACK = Acknowledge

S = Start

P = Stop

I = Auto Increment

X = Not used

A = I²C address value selectable according to ADDR pin status

ADDR = Open/Gnd A = 0

ADDR = V_{CC} A = 1

MAX CLOCK SPEED 500kbts/s

4.2 Auto increment

If bit I in the subaddress byte is set to "1", the autoincrement of the subaddress is enabled

Table 5. Subaddress (receive mode)

MSB				LSB				Function
X	X	X	I	A3	A2	A1	A0	
				0	0	0	0	Input Selector
				0	0	0	1	Loudness
				0	0	1	0	Volume
				0	0	1	1	Bass, Treble
				0	1	0	0	Speaker Attenuator LF
				0	1	0	1	Speaker Attenuator LR
				0	1	1	0	Speaker Attenuator RF
				0	1	1	1	Speaker Attenuator RR
				1	0	0	0	Mute

4.3 Transmitted data

Table 6. Send mode

MSB							LSB
X	X	X	X	X	SM	ZM	X

ZM = Zero crossing muted (HIGH active)

SM = Soft mute activated (HIGH active)

X = Not used

The transmitted data is automatically updated after each ACK.

Transmission can be repeated without new chip address.

4.4 Data byte specification

X = not relevant; set to "1" during testing

Table 7. Input selector

MSB							LSB	Function
D7	D6	D5	D4	D3	D2	D1	D0	
0		1			0	0	0	not used
0		1			0	0	1	IN 2
0		1			0	1	0	IN 1
0		1			0	1	1	AM mono
0		1			1	0	0	not used
0		1			1	0	1	not used
0		1			1	1	0	not allowed
0		1			1	1	1	not allowed
0		1	0	0				11.25dB gain
0		1	0	1				7.5dB gain
0		1	1	0				3.75dB gain
0		1	1	1				0dB gain
	0							0dB differential input gain (IN3)
	1							-6dB differential input gain (IN3)

For example to select the IN 2 input with a gain of 7.5dB the Data Byte is: X X 1 0 1 0 0 1

Table 8. Loudness

MSB							LSB		Function
D7	D6	D5	D4	D3	D2	D1	D0		
X	X	X	0	0	0	0	0	0dB	
X	X	X	0	0	0	0	1	-1.25dB	
X	X	X	0	0	0	1	0	-2.5dB	
X	X	X	0	0	0	1	1	-3.75dB	
X	X	X	0	0	1	0	0	-5dB	
X	X	X	0	0	1	0	1	-6.25dB	
X	X	X	0	0	1	1	0	-7.5dB	
X	X	X	0	0	1	1	1	-8.75dB	
X	X	X	0	1	0	0	0	-10dB	
X	X	X	0	1	0	0	1	-11.25dB	
X	X	X	0	1	0	1	0	-12.5dB	
X	X	X	0	1	0	1	1	-13.75dB	
X	X	X	0	1	1	0	0	-15dB	
X	X	X	0	1	1	0	1	-16.25dB	
X	X	X	0	1	1	1	0	-17.5dB	
X	X	X	0	1	1	1	1	-18.75dB	
X	X	X	1	D3	D2	D1	D0	Loudness OFF ⁽¹⁾	

1. If the loudness is switched OFF, the loudness stage is acting like a volume attenuator with flat frequency response. D0 to D3 determine the attenuation level.

For example to select -17.5dB attenuation, loudness OFF, the Data Byte is: X X X1 1 1 1 0

Table 9. Mute

MSB							LSB		Function
D7	D6	D5	D4	D3	D2	D1	D0		
							1	Soft Mute On	
							0	1	Soft Mute with fast slope ($I = I_{MAX}$)
							1	1	Soft Mute with slow slope ($I = I_{MIN}$)
				1					Direct Mute
			0		1				Zero Crossing Mute On
			0		0				Zero Crossing Mute Off (delayed until next zerocrossing)
			1						Zero Crossing Mute and Pause Detector Reset
	0	0							160mV ZC Window Threshold (WIN = 00)

Table 9. Mute (continued)

MSB							LSB		Function
D7	D6	D5	D4	D3	D2	D1	D0		
	0	1						80mV ZC Window Threshold (WIN = 01)	
	1	0						40mV ZC Window Threshold (WIN = 10)	
	1	1						20mV ZC Window Threshold (WIN = 11)	
0								Nonsymmetrical Bass Cut ⁽¹⁾	
1								Symmetrical Bass Cut	

1. Bass cut for very low frequencies; should not be used at +16 and +18dB bass boost (DC gain)

An additional direct mute function is included in the Speaker Attenuators.

Table 10. Speaker attenuators (LF, LR, RF, RR)

MSB							LSB		Function
D7	D6	D5	D4	D3	D2	D1	D0		
1.25dB step									
X	X	X			0	0	0	0dB	
X	X	X			0	0	1	-1.25dB	
X	X	X			0	1	0	-2.5dB	
X	X	X			0	1	1	-3.75dB	
X	X	X			1	0	0	-5dB	
X	X	X			1	0	1	-6.25dB	
X	X	X			1	1	0	-7.5dB	
X	X	X			1	1	1	-8.75dB	
10dB step									
X	X	X	0	0				0dB	
X	X	X	0	1				-10dB	
X	X	X	1	0				-20dB	
X	X	X	1	1				-30dB	
X	X	X	1	1	1	1	1	Speaker Mute	

For example an attenuation of 25dB on a selected output is given by: X X X1 0 1 0 0

Table 11. Bass/Treble

MSB							LSB		Function
D7	D6	D5	D4	D3	D2	D1	D0		
Treble step									
				0	0	0	0	-14dB	
				0	0	0	1	-12dB	

Table 11. Bass/Treble (continued)

MSB				LSB				Function
D7	D6	D5	D4	D3	D2	D1	D0	
				0	0	1	0	-10dB
				0	0	1	1	-8dB
				0	1	0	0	-6dB
				0	1	0	1	-4dB
				0	1	1	0	-2dB
				0	1	1	1	0dB
				1	1	1	1	0dB
				1	1	1	0	2dB
				1	1	0	1	4dB
				1	1	0	0	6dB
				1	0	1	1	8dB
				1	0	1	0	10dB
				1	0	0	1	12dB
				1	0	0	0	14dB
								Bass steps
0	0	1	0					-10dB
0	0	1	1					-8dB
0	1	0	0					-6dB
0	1	0	1					-4dB
0	1	1	0					-2dB
0	1	1	1					-0dB
1	1	1	1					-0dB
1	1	1	0					2dB
1	1	0	1					4dB
1	1	0	0					6dB
1	0	1	1					8dB
1	0	1	0					10dB
1	0	0	1					12dB
1	0	0	0					14dB
0	0	0	1					146B
0	0	0	0					18dB

For example 12dB Treble and -8dB Bass give the following DATA BYTE: 0 0 1 1 1 0 0 1

Table 12. Volume

MSB						LSB		Function
D7	D6	D5	D4	D3	D2	D1	D0	
								0.31dB Fine Attenuation Steps
						0	0	0dB
						0	1	-0.31dB
						1	0	-0.62dB
						1	1	-0.94dB
								1.25dB Coarse Attenuation Steps
			0	0	0			0dB
			0	0	1			-1.25dB
			0	1	0			-2.5dB
			0	1	1			-3.75dB
			1	0	0			-5dB
			1	0	1			-6.25dB
			1	1	0			-7.5dB
			1	1	1			-8.75dB
								10dB Gain / Attenuation Steps
0	0	0						20dB
0	0	1						10dB
0	1	0						0dB
0	1	1						-10dB
1	0	0						-20dB
1	0	1						-30dB
1	1	0						-40dB
1	1	1						-50dB

For example to select -47.81dB Volume the Data Byte is: 1 1 0 1 1 0 0 1

Power on RESET: All Bytes Set to 1 1 1 1 1 1 1 0

5 Package information

In order to meet environmental requirements, ST offers these devices in ECOPACK® packages. These packages have a Lead-free second level interconnect. The category of second Level Interconnect is marked on the package and on the inner box label, in compliance with JEDEC Standard JESD97. The maximum ratings related to soldering conditions are also marked on the inner box label. ECOPACK is an ST trademark. ECOPACK specifications are available at: www.st.com.

Figure 7. LQFP32 Mechanical Data & Package Dimensions

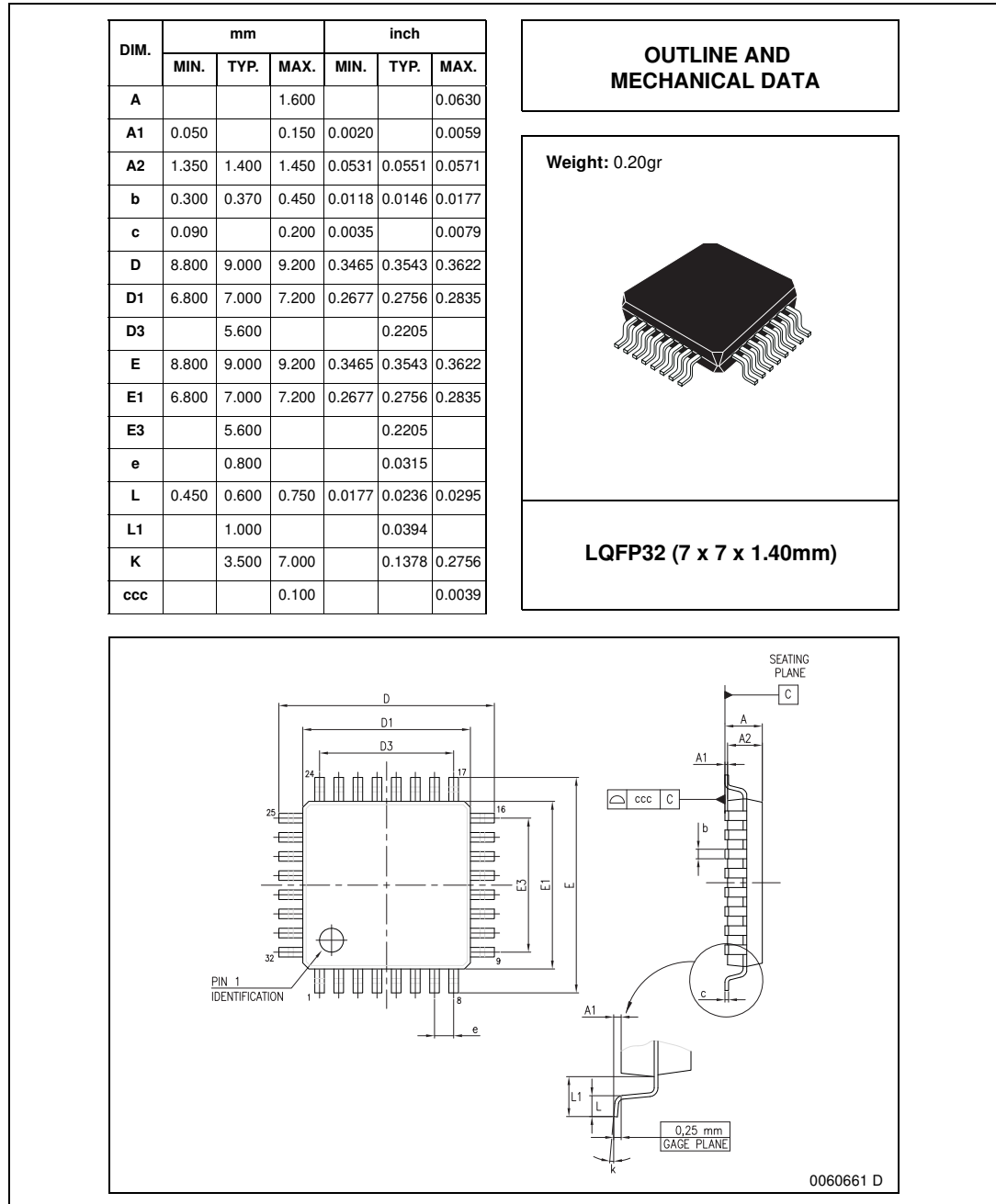

6 Revision history

Table 13. Document revision history

Date	Revision	Changes
24-Jan-2006	1	Initial release.
20-Nov-2006	2	Layout changes, text modifications, updated package informations.
24-Sep-2013	3	Updated Disclaimer.

Please Read Carefully:

Information in this document is provided solely in connection with ST products. STMicroelectronics NV and its subsidiaries ("ST") reserve the right to make changes, corrections, modifications or improvements, to this document, and the products and services described herein at any time, without notice.

All ST products are sold pursuant to ST's terms and conditions of sale.

Purchasers are solely responsible for the choice, selection and use of the ST products and services described herein, and ST assumes no liability whatsoever relating to the choice, selection or use of the ST products and services described herein.

No license, express or implied, by estoppel or otherwise, to any intellectual property rights is granted under this document. If any part of this document refers to any third party products or services it shall not be deemed a license grant by ST for the use of such third party products or services, or any intellectual property contained therein or considered as a warranty covering the use in any manner whatsoever of such third party products or services or any intellectual property contained therein.

UNLESS OTHERWISE SET FORTH IN ST'S TERMS AND CONDITIONS OF SALE ST DISCLAIMS ANY EXPRESS OR IMPLIED WARRANTY WITH RESPECT TO THE USE AND/OR SALE OF ST PRODUCTS INCLUDING WITHOUT LIMITATION IMPLIED WARRANTIES OF MERCHANTABILITY, FITNESS FOR A PARTICULAR PURPOSE (AND THEIR EQUIVALENTS UNDER THE LAWS OF ANY JURISDICTION), OR INFRINGEMENT OF ANY PATENT, COPYRIGHT OR OTHER INTELLECTUAL PROPERTY RIGHT.

ST PRODUCTS ARE NOT DESIGNED OR AUTHORIZED FOR USE IN: (A) SAFETY CRITICAL APPLICATIONS SUCH AS LIFE SUPPORTING, ACTIVE IMPLANTED DEVICES OR SYSTEMS WITH PRODUCT FUNCTIONAL SAFETY REQUIREMENTS; (B) AERONAUTIC APPLICATIONS; (C) AUTOMOTIVE APPLICATIONS OR ENVIRONMENTS, AND/OR (D) AEROSPACE APPLICATIONS OR ENVIRONMENTS. WHERE ST PRODUCTS ARE NOT DESIGNED FOR SUCH USE, THE PURCHASER SHALL USE PRODUCTS AT PURCHASER'S SOLE RISK, EVEN IF ST HAS BEEN INFORMED IN WRITING OF SUCH USAGE, UNLESS A PRODUCT IS EXPRESSLY DESIGNATED BY ST AS BEING INTENDED FOR "AUTOMOTIVE, AUTOMOTIVE SAFETY OR MEDICAL" INDUSTRY DOMAINS ACCORDING TO ST PRODUCT DESIGN SPECIFICATIONS. PRODUCTS FORMALLY ESCC, QML OR JAN QUALIFIED ARE DEEMED SUITABLE FOR USE IN AEROSPACE BY THE CORRESPONDING GOVERNMENTAL AGENCY.

Resale of ST products with provisions different from the statements and/or technical features set forth in this document shall immediately void any warranty granted by ST for the ST product or service described herein and shall not create or extend in any manner whatsoever, any liability of ST.

ST and the ST logo are trademarks or registered trademarks of ST in various countries.

Information in this document supersedes and replaces all information previously supplied.

The ST logo is a registered trademark of STMicroelectronics. All other names are the property of their respective owners.

© 2013 STMicroelectronics - All rights reserved

STMicroelectronics group of companies

Australia - Belgium - Brazil - Canada - China - Czech Republic - Finland - France - Germany - Hong Kong - India - Israel - Italy - Japan - Malaysia - Malta - Morocco - Philippines - Singapore - Spain - Sweden - Switzerland - United Kingdom - United States of America

www.st.com