



Chipsmall Limited consists of a professional team with an average of over 10 year of expertise in the distribution of electronic components. Based in Hongkong, we have already established firm and mutual-benefit business relationships with customers from,Europe,America and south Asia,supplying obsolete and hard-to-find components to meet their specific needs.

With the principle of “Quality Parts,Customers Priority,Honest Operation,and Considerate Service”,our business mainly focus on the distribution of electronic components. Line cards we deal with include Microchip,ALPS,ROHM,Xilinx,Pulse,ON,Everlight and Freescale. Main products comprise IC,Modules,Potentiometer,IC Socket,Relay,Connector.Our parts cover such applications as commercial,industrial, and automotives areas.

We are looking forward to setting up business relationship with you and hope to provide you with the best service and solution. Let us make a better world for our industry!



Contact us

Tel: +86-755-8981 8866 Fax: +86-755-8427 6832

Email & Skype: info@chipsmall.com Web: www.chipsmall.com

Address: A1208, Overseas Decoration Building, #122 Zhenhua RD., Futian, Shenzhen, China



Flat-type Proximity Sensor

- Flat Sensor with a thickness of 6 mm.
- IEC IP50 degree of protection assures that dust or dirt will not affect operation.
- Non-contact sensor assuring a long service life.
- Assures high-response with a frequency of 5 kHz.



 Be sure to read *Safety Precautions* on page 2.

Ordering Information

E2R Flat Proximity Sensor

Appearance	Sensing distance	Output configuration	Model
 Unshielded	5 mm	NO	E2R-A01

Accessories (Order Separately)

Connector

Appearance	Cable length	Model
	1 m	E22-01

Ratings and Specifications

Item	Model	E2R-A01
Sensing distance		5 mm±15%
Setting distance		0 to 3.4 mm
Differential travel		10% max. of sensing distance
Sensing object		Ferrous metals (refer to <i>Engineering Data</i> for non-ferrous metals) The sensing distance decreases with non-magnetic metal.)
Standard sensing object		Iron, 18 × 18 × 1 mm
Response frequency *		5 kHz min.
Power supply voltage (operating voltage)		12 VDC -10% to 24 VDC +15%, ripple (p-p): 10% max.
Current consumption		8 mA
Control output	Switching capacity	NPN open-collector output, 100 mA max. (30 VDC max.)
	Residual voltage	1.0 V max. (under load current of 100 mA with cable length of 1 m)
Indicators		Operation indicator (red)
Operation mode (with sensing object approaching)		NO Refer to the timing charts under <i>I/O Circuit Diagrams</i> on the next page for details.
Ambient temperature		Operating: -10 to 55°C (with no icing or condensation) Storage: -25 to 65°C (with no icing or condensation)
Ambient humidity		Operating/Storage: 35% to 85% (with no condensation)
Temperature influence		±20% max. of sensing distance at 23°C in the temperature range of -10 to 55°C
Voltage influence		±2.5% max. of sensing distance within a range of ±10% of rated power supply voltage
Insulation resistance		50 MΩ min. (at 500 VDC) between current-carrying parts and case
Dielectric strength		1000 VAC, 50/60 Hz for 1 min between current-carrying parts and case
Vibration resistance (destruction)		10 to 55 Hz, 1.5-mm double amplitude for 2 hrs each in X, Y, and Z directions
Shock resistance (destruction)		500 m/s ² 3 times in each X, Y and Z directions
Degree of protection		IEC IP50
Connection method		Connector
Weight (packed state)		Approx. 5.5 g
Materials		Case: Polybutylene terephthalate Rear cover: ABS resin

* The response frequencies for DC switching and average values measured on condition that the distance between each sensing object is twice as large as the size of the standard object and the sensing distance set is half of the maximum sensing distance.

Engineering Data (Typical)

Sensing Area

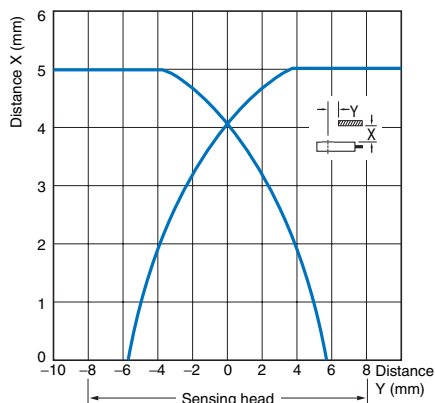

Influence of Sensing Object Size and Material

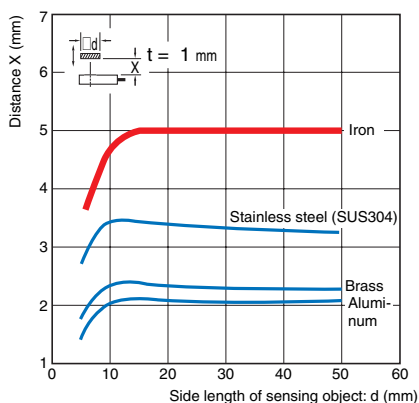

I/O Circuit Diagrams

Operation mode	Timing charts	Output circuits
NO	<p>Sensing object Present</p> <p>Not present</p> <p>Output transistor (Load) ON</p> <p>OFF</p> <p>Operation indicator (red) ON</p> <p>OFF</p>	<p>* Load current: 100 mA max.</p>

Safety Precautions

WARNING

This product is not designed or rated for ensuring safety of persons. Do not use it for such purposes.



Precautions for Correct Use

Do not use this product under ambient conditions that exceed the ratings.

● Design

Effects of Surrounding Metal

If there is any metal near the Sensor, the metal may cause reset failure. Even if reset failure does not occur, the temperature of the metal may affect the sensing distance of the E2R. Make sure that the clearances given in the following illustrations are maintained for accurate sensing operation.

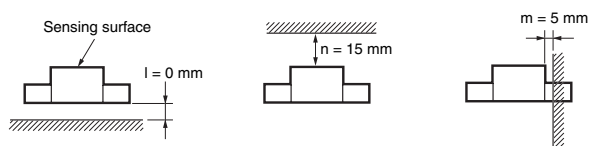

Mutual Interference

When installing two or more E2R units face to face or side by side, make sure that the minimum distances given in the following illustrations are maintained.

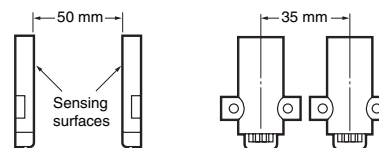

● Mounting

- The maximum tightening torque that should be applied to the mounting screws is 0.49 N·m.
- Do not impose external force on the terminal as shown in the following illustration, otherwise the terminal may be damaged.

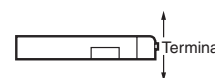

● Connections

- The E2R incorporates a connector. Do not solder connector pins to lead wires.
- Use the E22-01 Connector or Japan Molex connector block (housing 5209-03 and terminal 5103).
- Do not connect or disconnect the connector with the E2R turned on, otherwise the E2R may be damaged.

● Power Supply

When using a standard switching regulator with the E2R, ground the frame ground (FG) and ground (G) terminals of the switching regulator for stable operation.

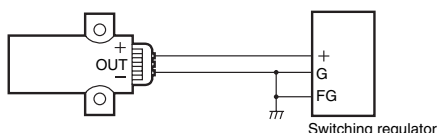

(Unit: mm)

Dimensions

Unless otherwise specified, the tolerance class IT16 is used for dimensions in this data sheet.

E2R

E2R-A01

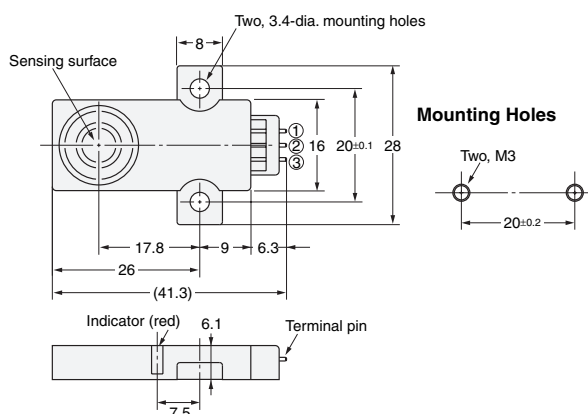
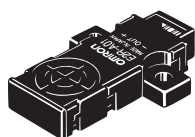

Terminal Arrangement

1	⊕	Power supply (+V)
2	OUT	Output
3	⊖	Power supply (0 V)

Accessories (Order Separately)

E22-01 Connector

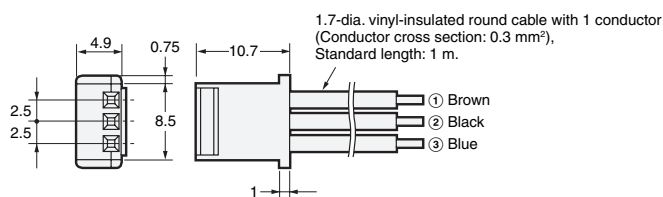
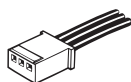

Note: Japan Molex's connector block (housing 5209-03 and terminal 5103) is used.

In the interest of product improvement, specifications are subject to change without notice.

Read and Understand This Catalog

Please read and understand this catalog before purchasing the products. Please consult your OMRON representative if you have any questions or comments.

Warranty and Limitations of Liability

WARRANTY

OMRON's exclusive warranty is that the products are free from defects in materials and workmanship for a period of one year (or other period if specified) from date of sale by OMRON.

OMRON MAKES NO WARRANTY OR REPRESENTATION, EXPRESS OR IMPLIED, REGARDING NON-INFRINGEMENT, MERCHANTABILITY, OR FITNESS FOR PARTICULAR PURPOSE OF THE PRODUCTS. ANY BUYER OR USER ACKNOWLEDGES THAT THE BUYER OR USER ALONE HAS DETERMINED THAT THE PRODUCTS WILL SUITABLY MEET THE REQUIREMENTS OF THEIR INTENDED USE. OMRON DISCLAIMS ALL OTHER WARRANTIES, EXPRESS OR IMPLIED.

LIMITATIONS OF LIABILITY

OMRON SHALL NOT BE RESPONSIBLE FOR SPECIAL, INDIRECT, OR CONSEQUENTIAL DAMAGES, LOSS OF PROFITS OR COMMERCIAL LOSS IN ANY WAY CONNECTED WITH THE PRODUCTS, WHETHER SUCH CLAIM IS BASED ON CONTRACT, WARRANTY, NEGLIGENCE, OR STRICT LIABILITY.

In no event shall the responsibility of OMRON for any act exceed the individual price of the product on which liability is asserted.

IN NO EVENT SHALL OMRON BE RESPONSIBLE FOR WARRANTY, REPAIR, OR OTHER CLAIMS REGARDING THE PRODUCTS UNLESS OMRON'S ANALYSIS CONFIRMS THAT THE PRODUCTS WERE PROPERLY HANDLED, STORED, INSTALLED, AND MAINTAINED AND NOT SUBJECT TO CONTAMINATION, ABUSE, MISUSE, OR INAPPROPRIATE MODIFICATION OR REPAIR.

Application Considerations

SUITABILITY FOR USE

OMRON shall not be responsible for conformity with any standards, codes, or regulations that apply to the combination of products in the customer's application or use of the products.

At the customer's request, OMRON will provide applicable third party certification documents identifying ratings and limitations of use that apply to the products. This information by itself is not sufficient for a complete determination of the suitability of the products in combination with the end product, machine, system, or other application or use.

The following are some examples of applications for which particular attention must be given. This is not intended to be an exhaustive list of all possible uses of the products, nor is it intended to imply that the uses listed may be suitable for the products:

- Outdoor use, uses involving potential chemical contamination or electrical interference, or conditions or uses not described in this catalog.
- Nuclear energy control systems, combustion systems, railroad systems, aviation systems, medical equipment, amusement machines, vehicles, safety equipment, and installations subject to separate industry or government regulations.
- Systems, machines, and equipment that could present a risk to life or property.

Please know and observe all prohibitions of use applicable to the products.

NEVER USE THE PRODUCTS FOR AN APPLICATION INVOLVING SERIOUS RISK TO LIFE OR PROPERTY WITHOUT ENSURING THAT THE SYSTEM AS A WHOLE HAS BEEN DESIGNED TO ADDRESS THE RISKS, AND THAT THE OMRON PRODUCTS ARE PROPERLY RATED AND INSTALLED FOR THE INTENDED USE WITHIN THE OVERALL EQUIPMENT OR SYSTEM.

PROGRAMMABLE PRODUCTS

OMRON shall not be responsible for the user's programming of a programmable product, or any consequence thereof.

Disclaimers

CHANGE IN SPECIFICATIONS

Product specifications and accessories may be changed at any time based on improvements and other reasons.

It is our practice to change model numbers when published ratings or features are changed, or when significant construction changes are made. However, some specifications of the products may be changed without any notice. When in doubt, special model numbers may be assigned to fix or establish key specifications for your application on your request. Please consult with your OMRON representative at any time to confirm actual specifications of purchased products.

DIMENSIONS AND WEIGHTS

Dimensions and weights are nominal and are not to be used for manufacturing purposes, even when tolerances are shown.

PERFORMANCE DATA

Performance data given in this catalog is provided as a guide for the user in determining suitability and does not constitute a warranty. It may represent the result of OMRON's test conditions, and the users must correlate it to actual application requirements. Actual performance is subject to the OMRON Warranty and Limitations of Liability.

ERRORS AND OMISSIONS

The information in this document has been carefully checked and is believed to be accurate; however, no responsibility is assumed for clerical, typographical, or proofreading errors, or omissions.

2008.9

In the interest of product improvement, specifications are subject to change without notice.

OMRON Corporation
Industrial Automation Company

<http://www.ia.omron.com/>

(c)Copyright OMRON Corporation 2008 All Right Reserved.